

[54] COMBINED WALL-MOUNTED MIRROR,
RAZOR AND SHAVING CREAM HOLDER

[76] Inventor: **Ralph G. Smith**, 3408 Sunnyside Dr.,
Beavercreek, Ohio 45432

[**] Term: **14 Years**

[21] Appl. No.: **82,067**

[22] Filed: **Aug. 5, 1987**

[52] U.S. Cl. **D6/527; D6/524;**
D6/526

[58] Field of Search **D6/524, 526-527,**
D6/553, 567-569, 572; 211/13, 60.1, 86-88;
248/200, 201, 300-301, 309.1

[56] **References Cited**

U.S. PATENT DOCUMENTS

D. 258,474	3/1981	Edstrom	D6/526
D. 258,475	3/1981	Edstrom	D6/526
D. 279,630	7/1985	Bart	D6/449
2,472,058	6/1949	Artley	211/66 X

Primary Examiner—Wallace R. Burke
Assistant Examiner—Brian N. Vinson
Attorney, Agent, or Firm—Becker & Becker, Inc.

[57] **CLAIM**

The ornamental design for a combined wall-mounted mirror, razor and shaving cream holder, as shown and described.

DESCRIPTION

FIG. 1 is a perspective view of a combined wall-mounted mirror, razor and shaving cream holder showing my new design, the broken-line showing of the razor and shaving cream can being for illustrative purposes only and forming no part of the claimed design; FIG. 2 is a front elevational view thereof; FIG. 3 is a rear elevational view thereof; FIG. 4 is a left side elevational view thereof; FIG. 5 is a right side elevational view thereof; FIG. 6 is a top plan view thereof; and FIG. 7 is a bottom plan view thereof.

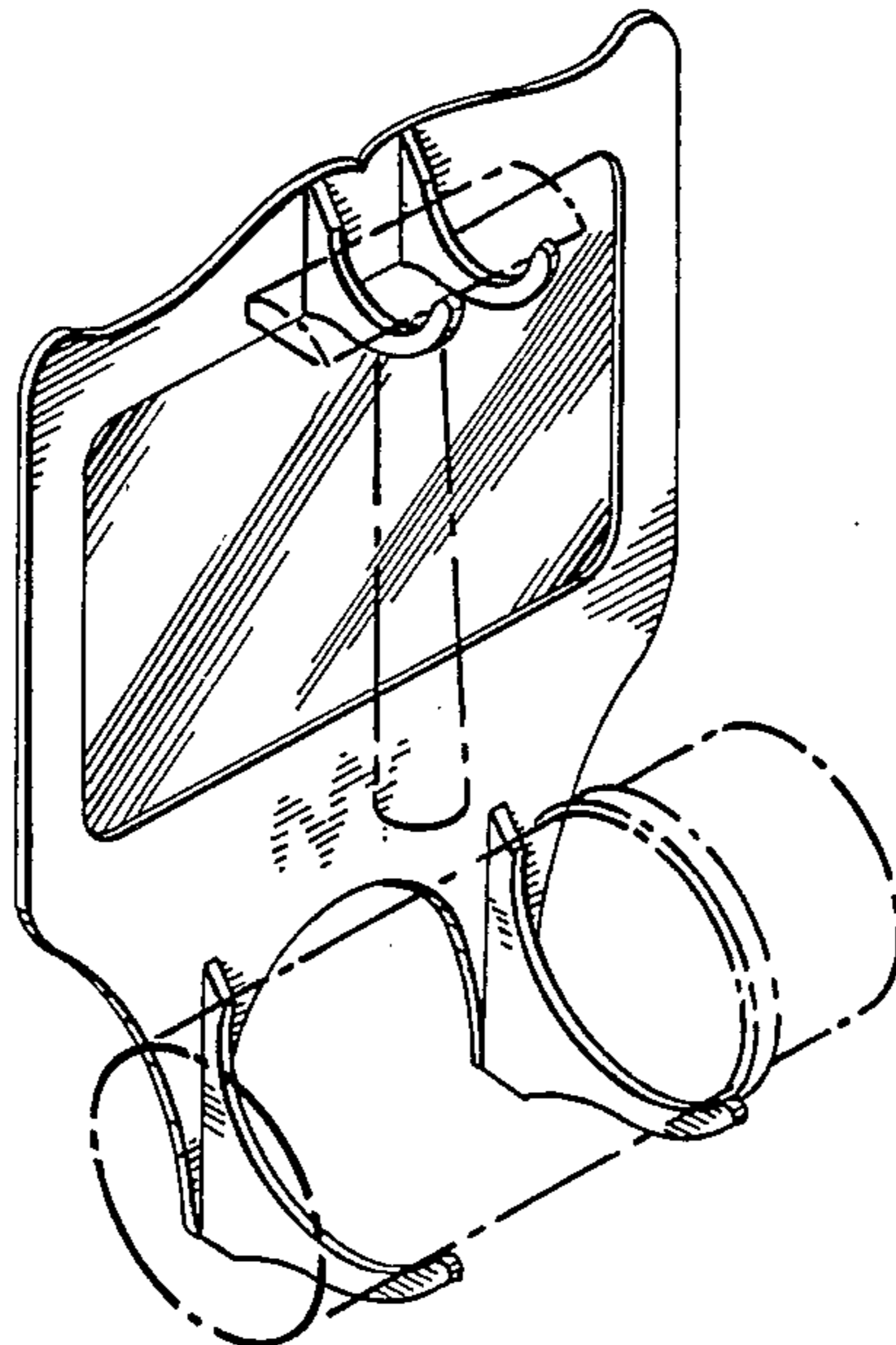

FIG-1

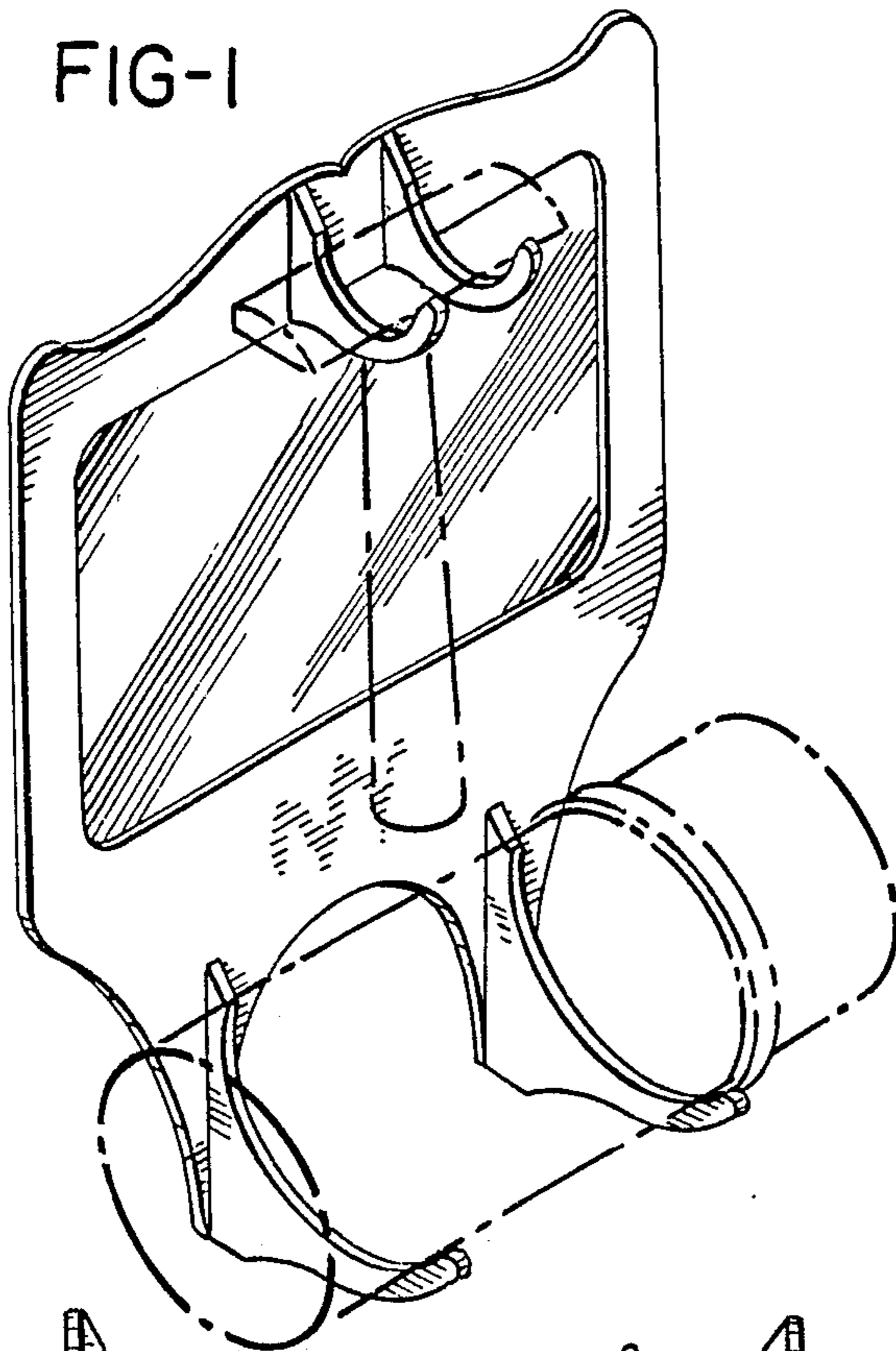

FIG-2

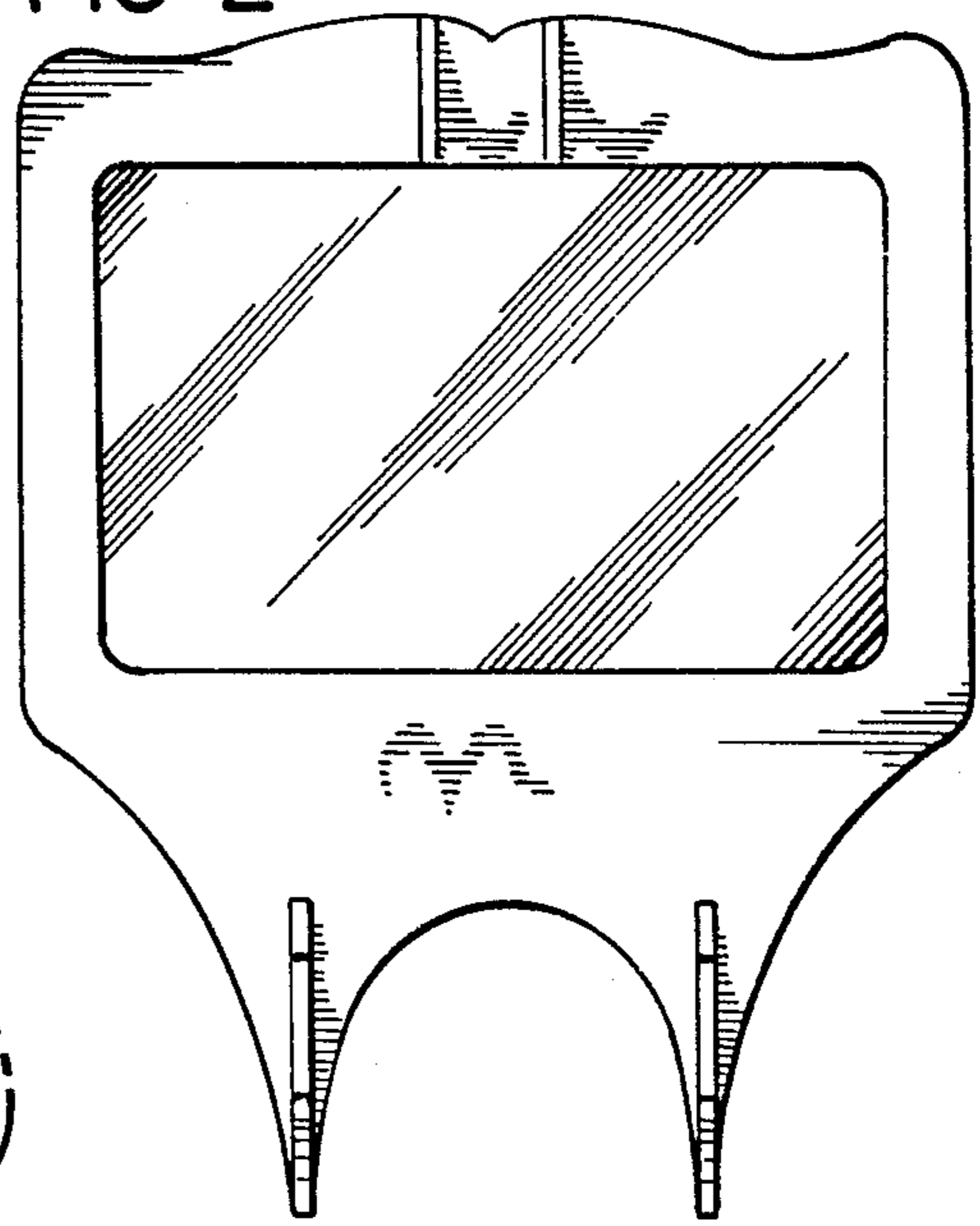

FIG-3

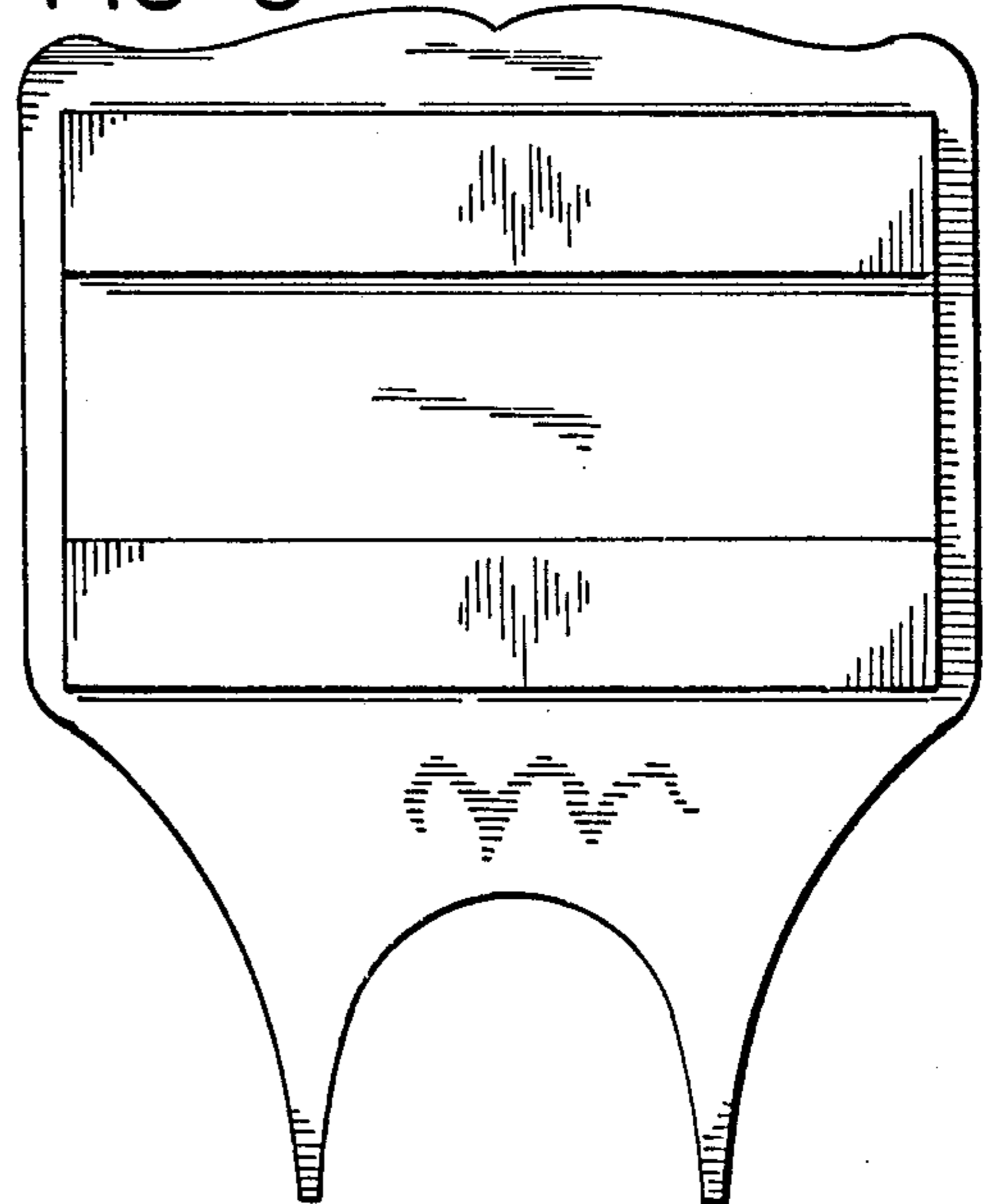

FIG-4

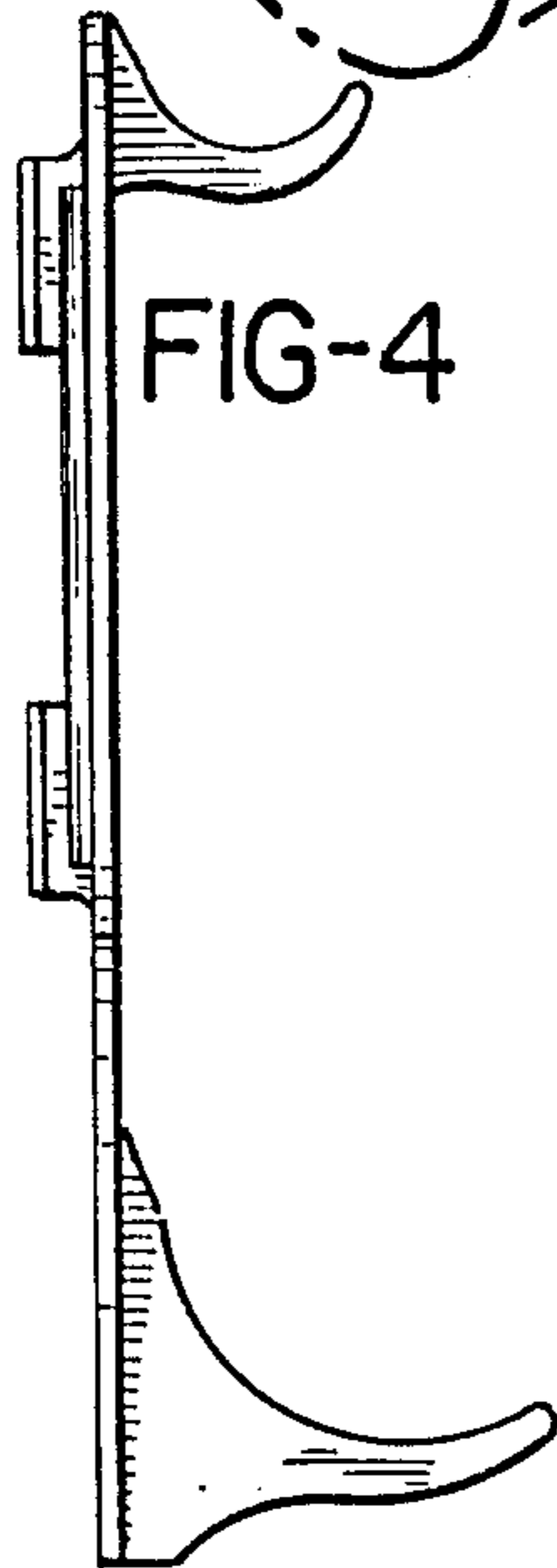

FIG-5

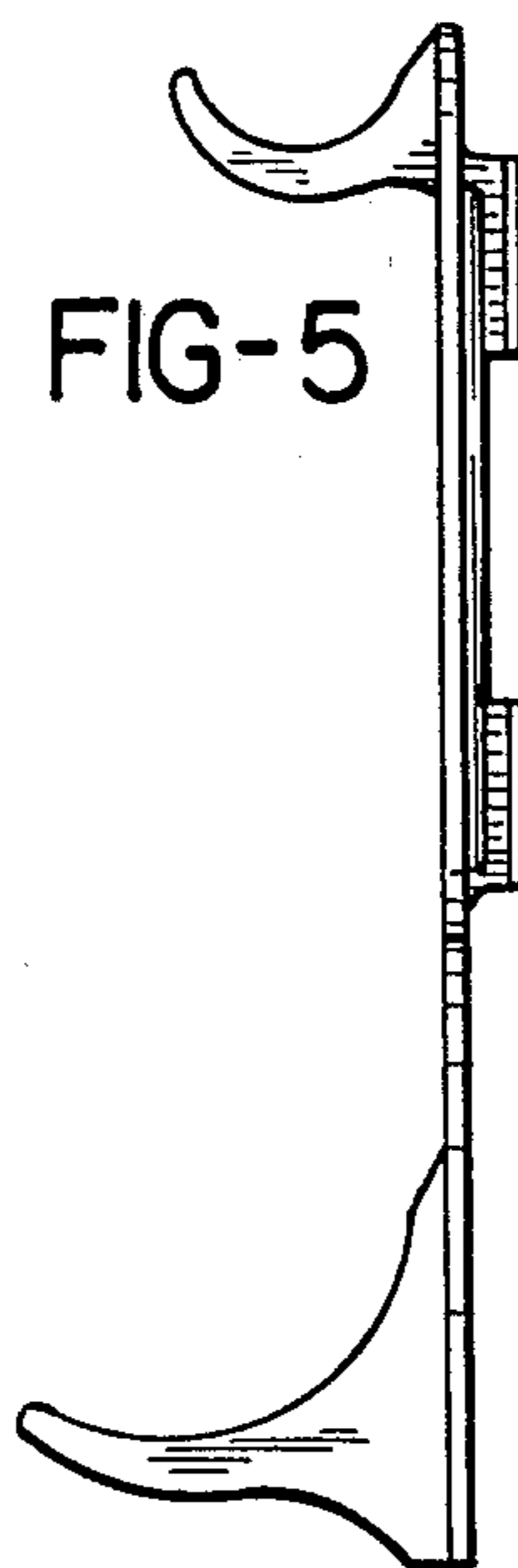

FIG-6

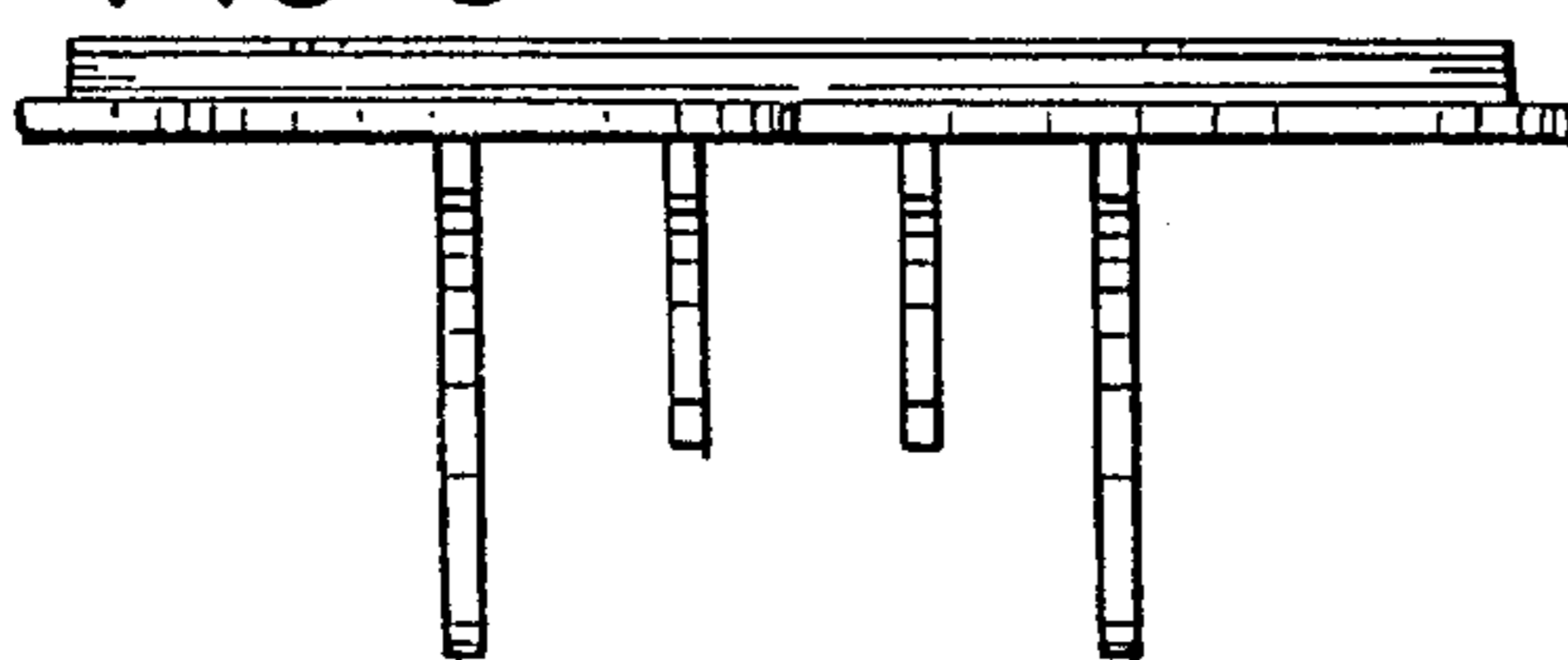

FIG-7

