

[54] CORDLESS TELEPHONE SET OR SIMILAR ARTICLE

[75] Inventor: Kenneth Reichenstein, Floral Park, N.Y.

[73] Assignee: Webcor Electronics Inc., Plainview, N.Y.

[**] Term: 14 Years

[21] Appl. No.: 156,226

[22] Filed: Feb. 16, 1988

[52] U.S. Cl. D14/138; D14/149; D14/142

[58] Field of Search D14/138, 142, 149, 151, D14/150, 248; 379/433, 435, 436, 419, 428, 440, 58, 59, 60; 455/89, 90

[56] References Cited

U.S. PATENT DOCUMENTS

D. 273,492	4/1984	Coons et al.	D14/147
D. 282,364	1/1986	Takahashi	D14/138
D. 283,420	4/1986	Reichenstein	D14/138
D. 283,889	5/1986	Steinbeck	D14/138

D. 285,436	9/1986	Klucznik et al.	D14/148
D. 285,437	9/1986	Buckler	D14/148
D. 287,487	12/1986	Sasaki et al.	D14/138
D. 291,305	8/1987	Harrison et al.	D14/148
D. 295,624	5/1988	Garcia	D14/248
D. 296,692	7/1988	Besford et al.	D14/148

Primary Examiner—Horace B. Fay, Jr.
Attorney, Agent, or Firm—John H. Crozier

[57] CLAIM

The ornamental design for a cordless telephone set or similar article, as shown and described.

DESCRIPTION

FIG. 1 is a bracket associated top plan of the base and bottom plan view of the handset of a cordless telephone set or similar article showing my new design; FIG. 2 is a top plan view of the set in cradled relationship; FIGS. 3 and 4 are respectively right and left side elevational views of the set as shown in FIG. 2; FIGS. 5 and 6 are respectively rear and front elevational views of the set in cradled relationship; and FIG. 7 is a bottom plan view of the base thereof.

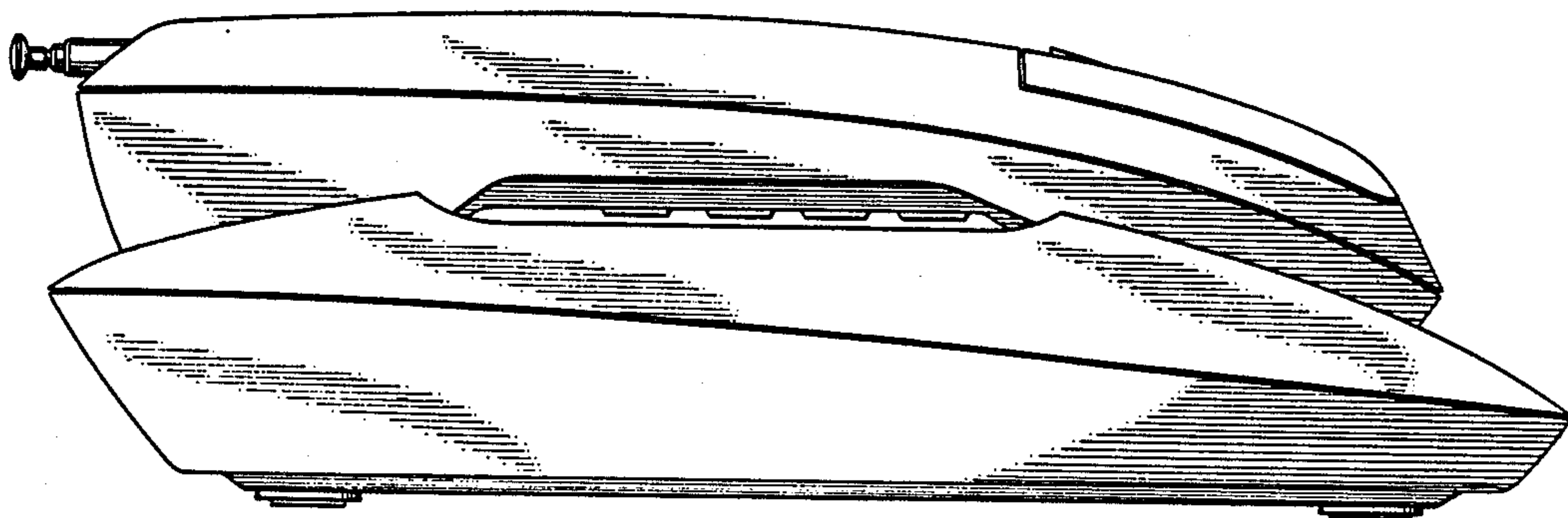
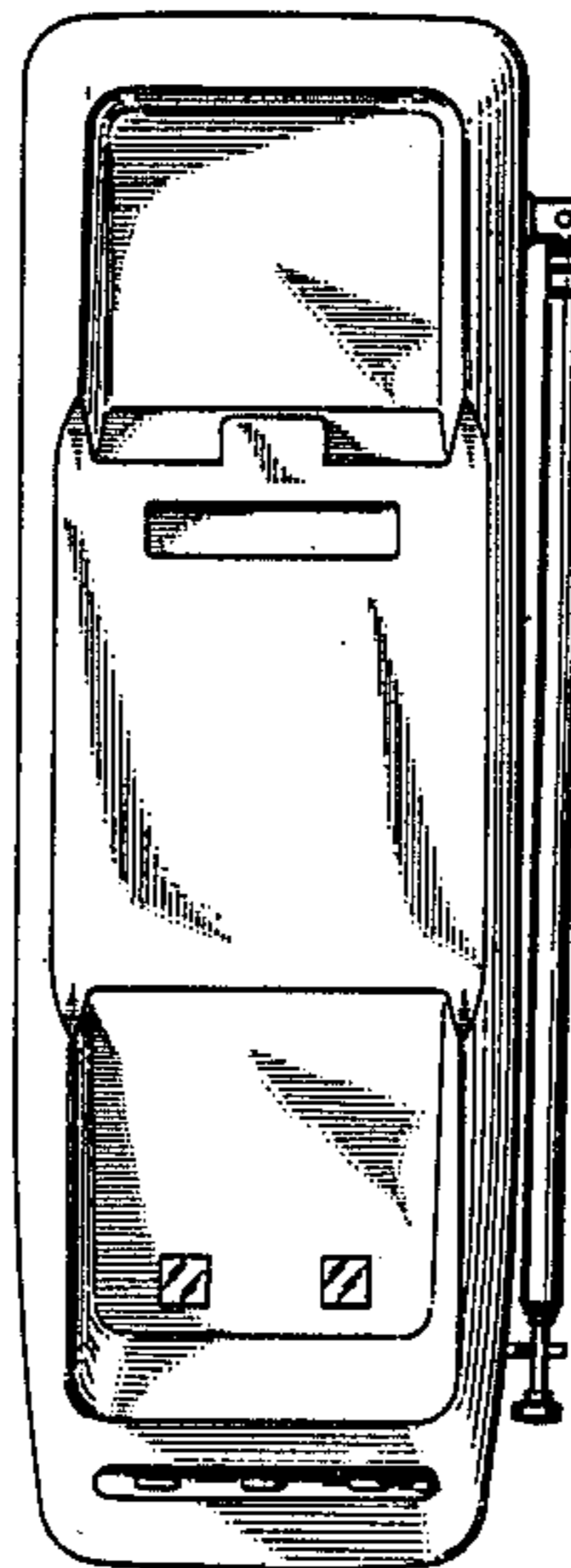
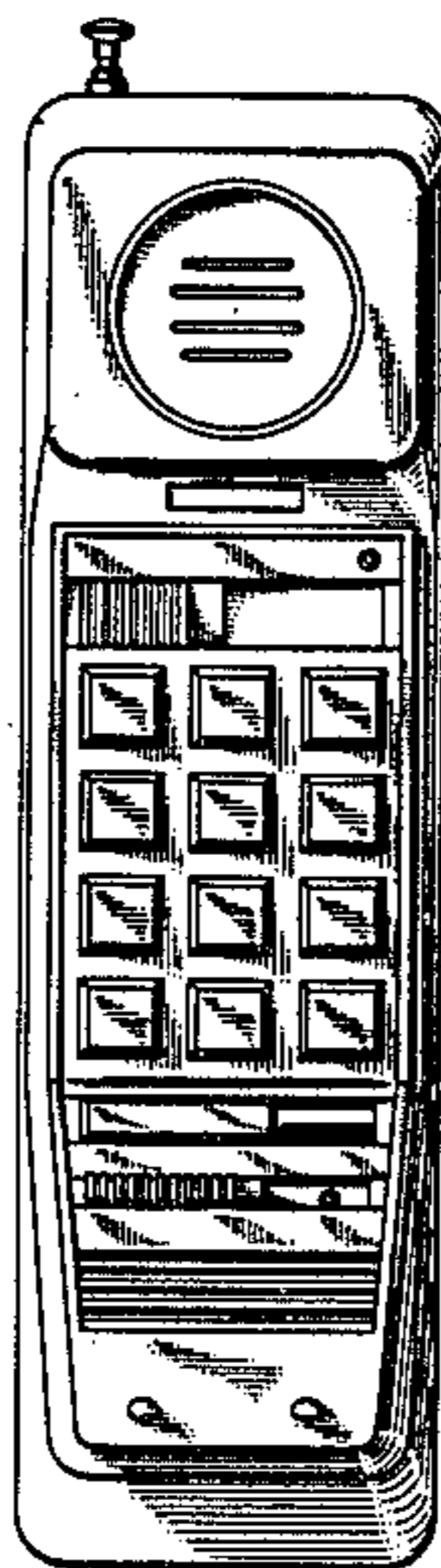

FIG. 1

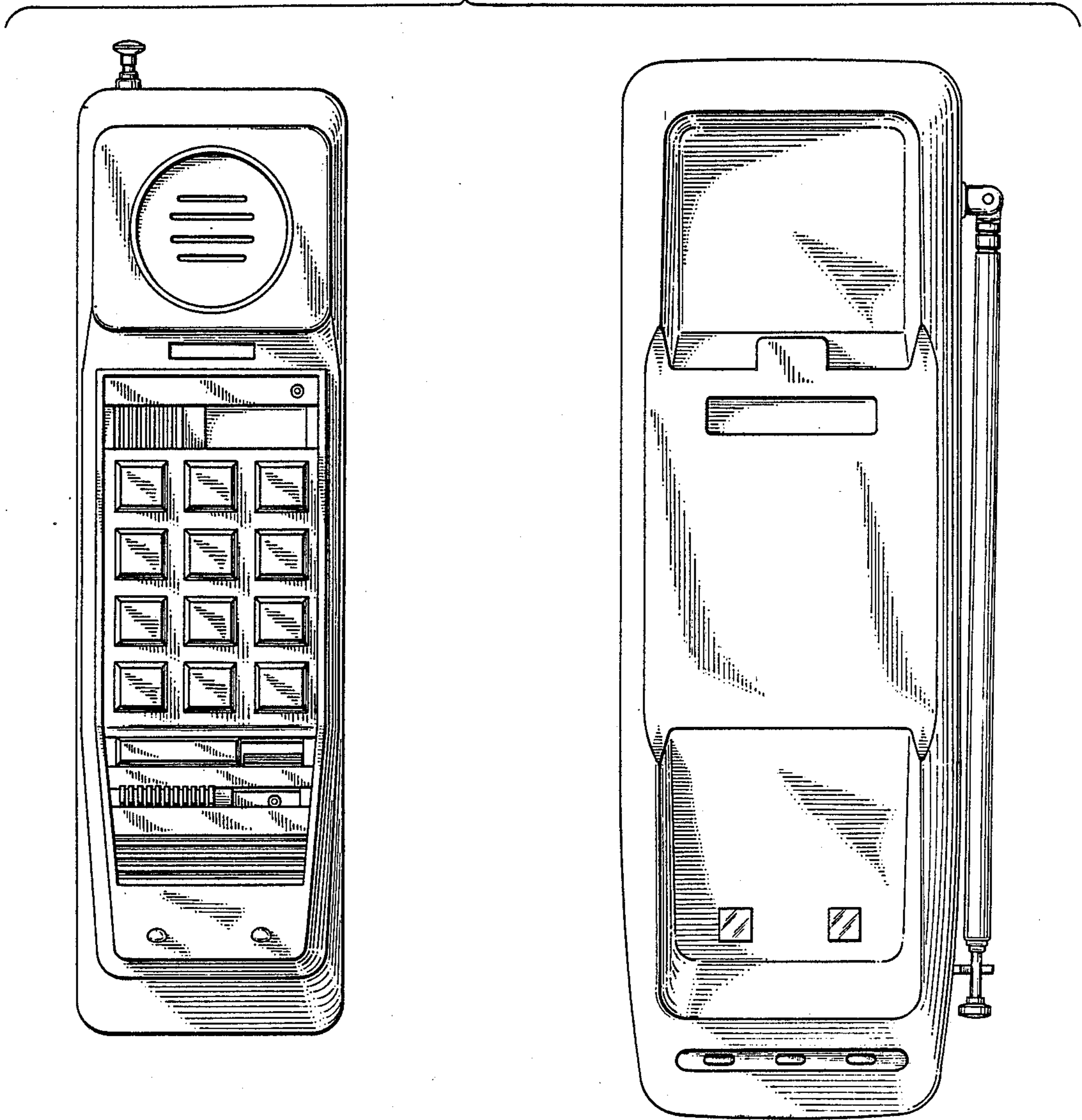

FIG. 2

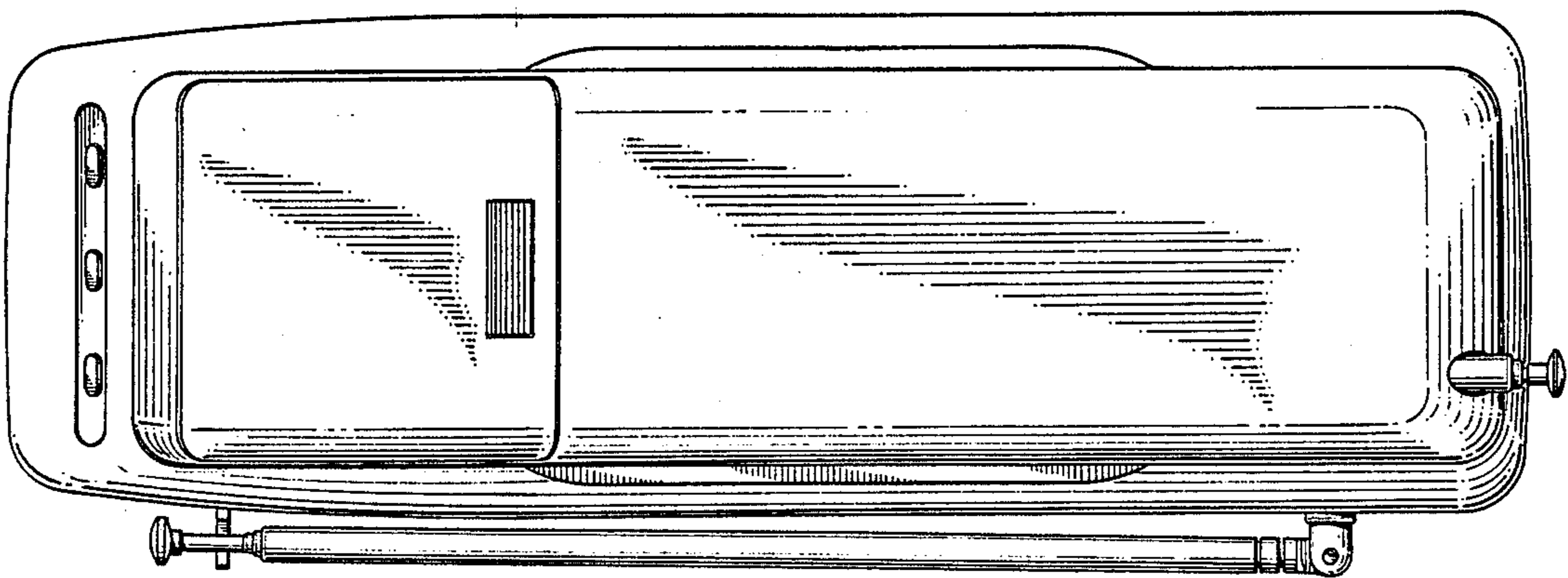

FIG. 3

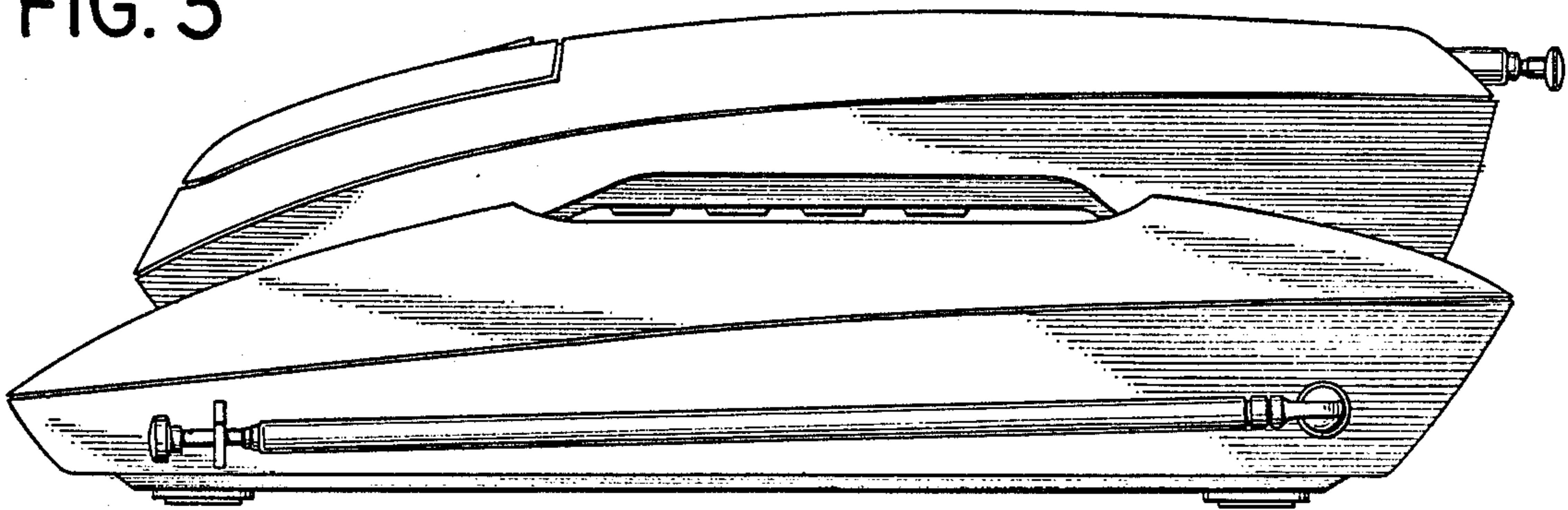

FIG. 4

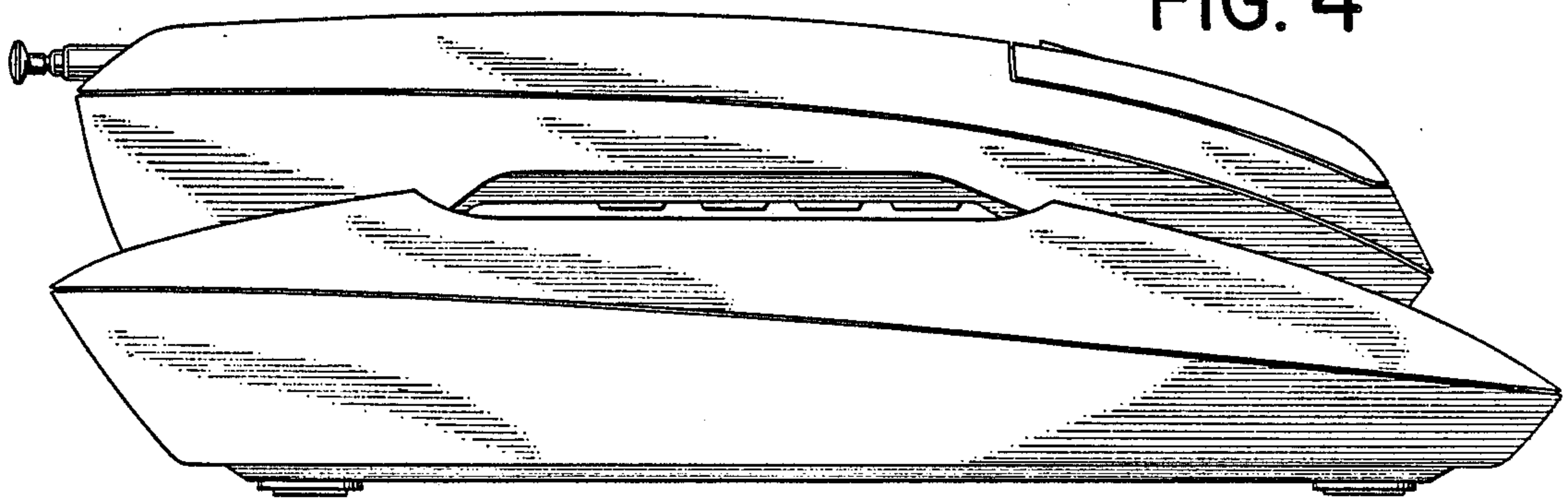

FIG. 5

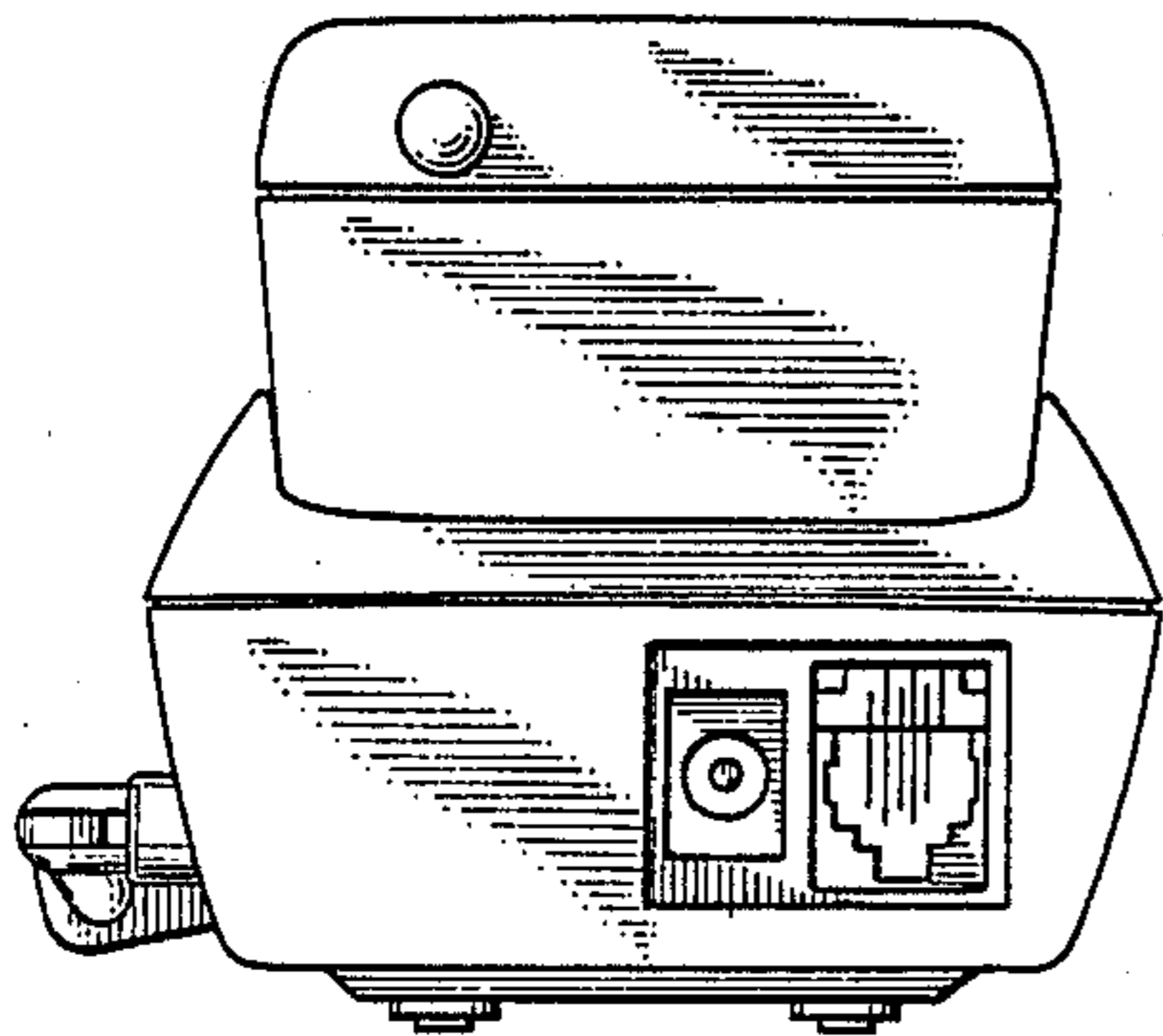

FIG. 6

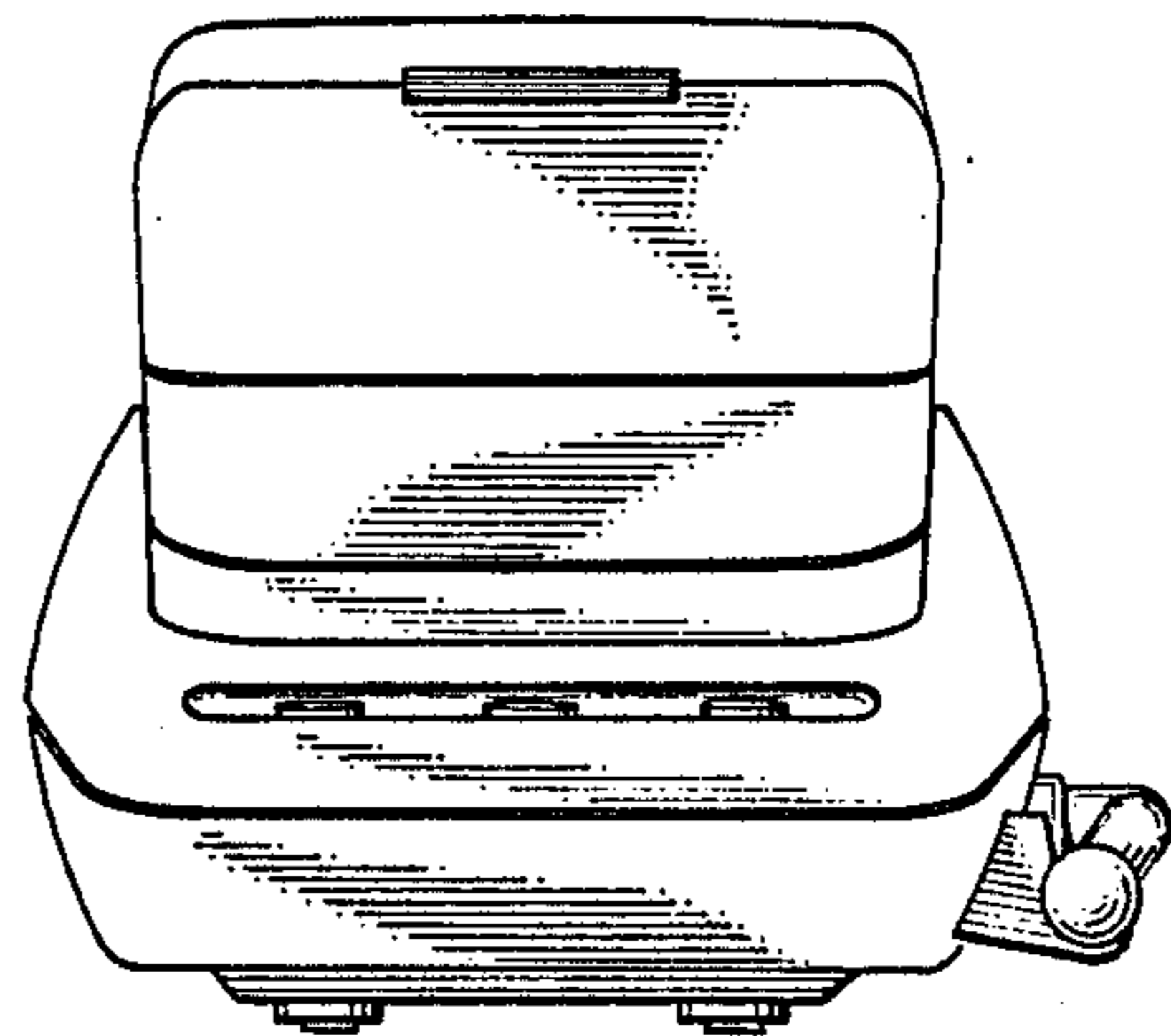

FIG. 7

