

[54] PLANTER

[75] Inventors: Russell P. Mottmiller; Jody A. Hobson; William C. Gerber, all of Wooster; Patrick C. Scofield, Columbus, all of Ohio

[73] Assignee: Rubbermaid Incorporated, Wooster, Ohio

[**] Term: 14 Years

[21] Appl. No.: 18,950

[22] Filed: Feb. 25, 1987

[52] U.S. Cl. D11/143; D11/155

[58] Field of Search D11/143-156; 47/66, 72, 79

[56] References Cited

U.S. PATENT DOCUMENTS

D. 252,869	9/1979	Dziewulski	D11/155
D. 256,682	9/1980	Lee et al.	D11/152
D. 259,710	6/1981	Stein	D11/152
D. 297,601	9/1988	Grossman et al.	D11/143

FOREIGN PATENT DOCUMENTS

2610787 8/1988 France 47/77

OTHER PUBLICATIONS

"Genie" Sale Sheet-Hydro-Planter Designs, Inc., 5510 Ambler Drive, Mississauga, Ontario, Canada, Published Date: Unknown. Sales Sheet-Gustavsberg, Division Plast, Interior Plast, S-13400 Gustavsberg, Sweden, Published: 1985.

Primary Examiner—B. J. Bullock
Attorney, Agent, or Firm—Richard B. O'Planick

[57] CLAIM

The ornamental design for a planter, as shown and described.

DESCRIPTION

FIG. 1 is an exploded perspective view of a planter embodying our new design.
FIG. 2 is an assembled perspective view thereof.
FIG. 3 is a front side elevational view thereof.
FIG. 4 is a top plan view thereof.
FIG. 5 is a side elevational view thereof, the side opposite being identical;
FIG. 6 is a reduced bottom plan view thereof.

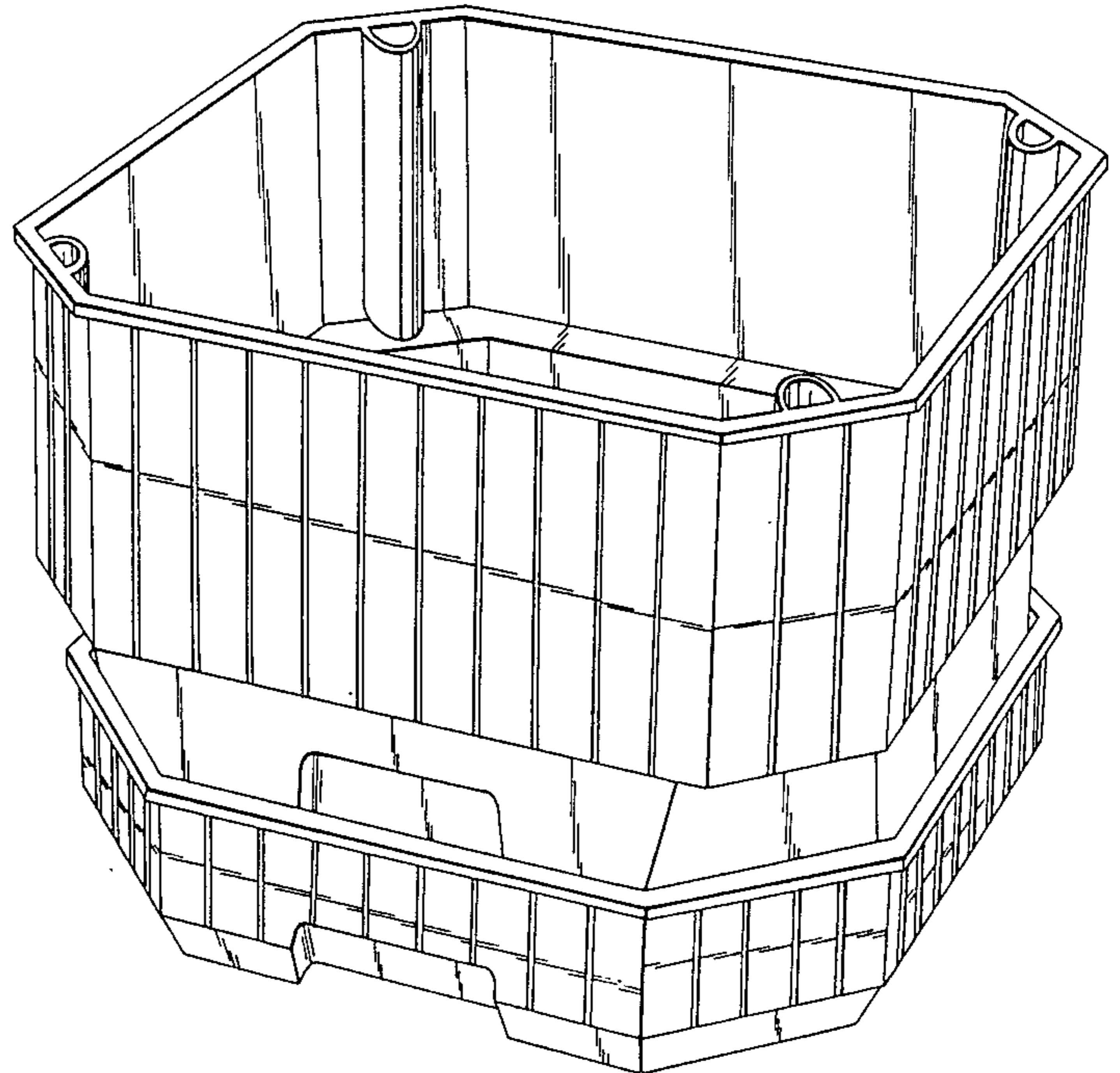
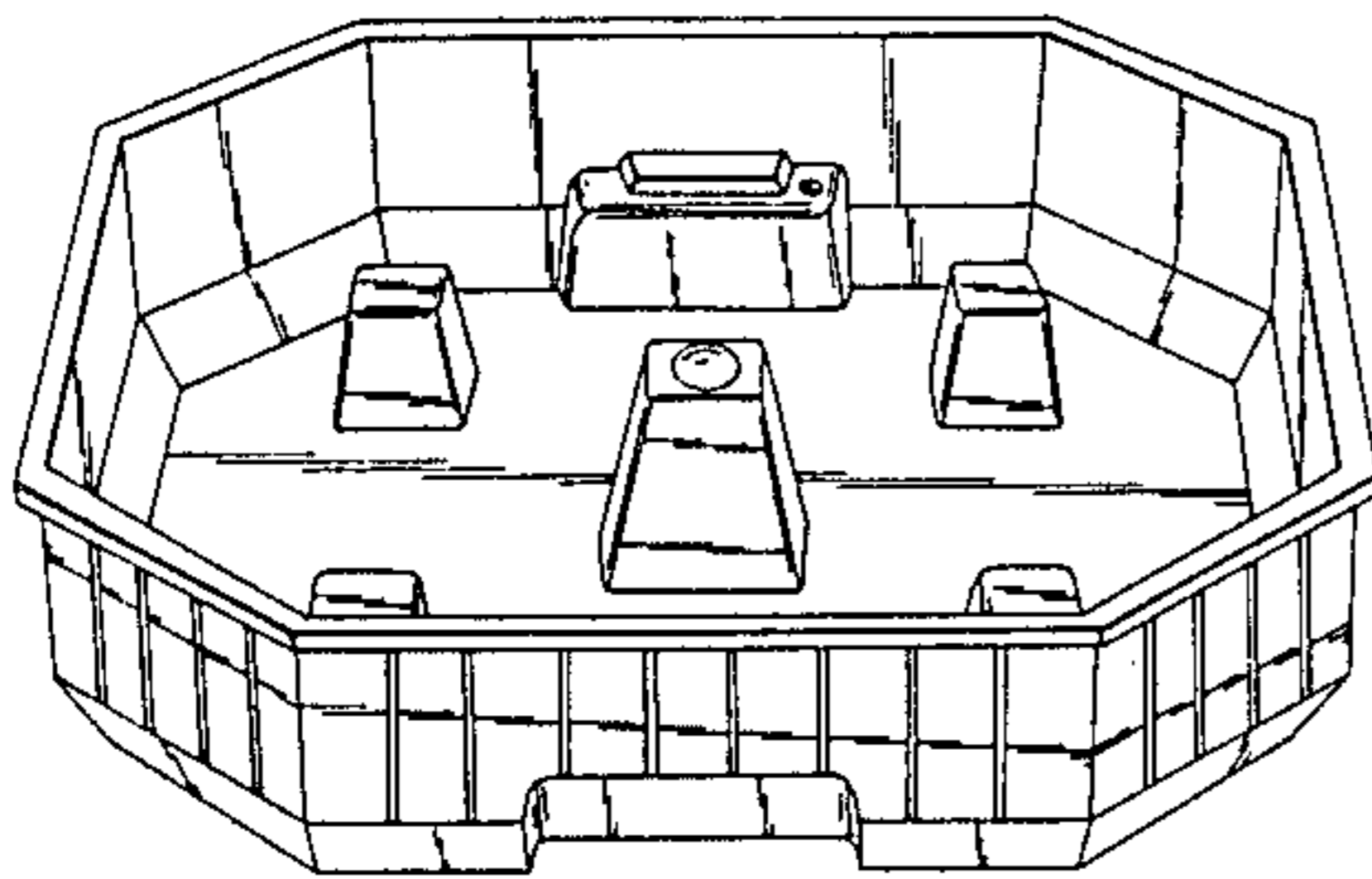
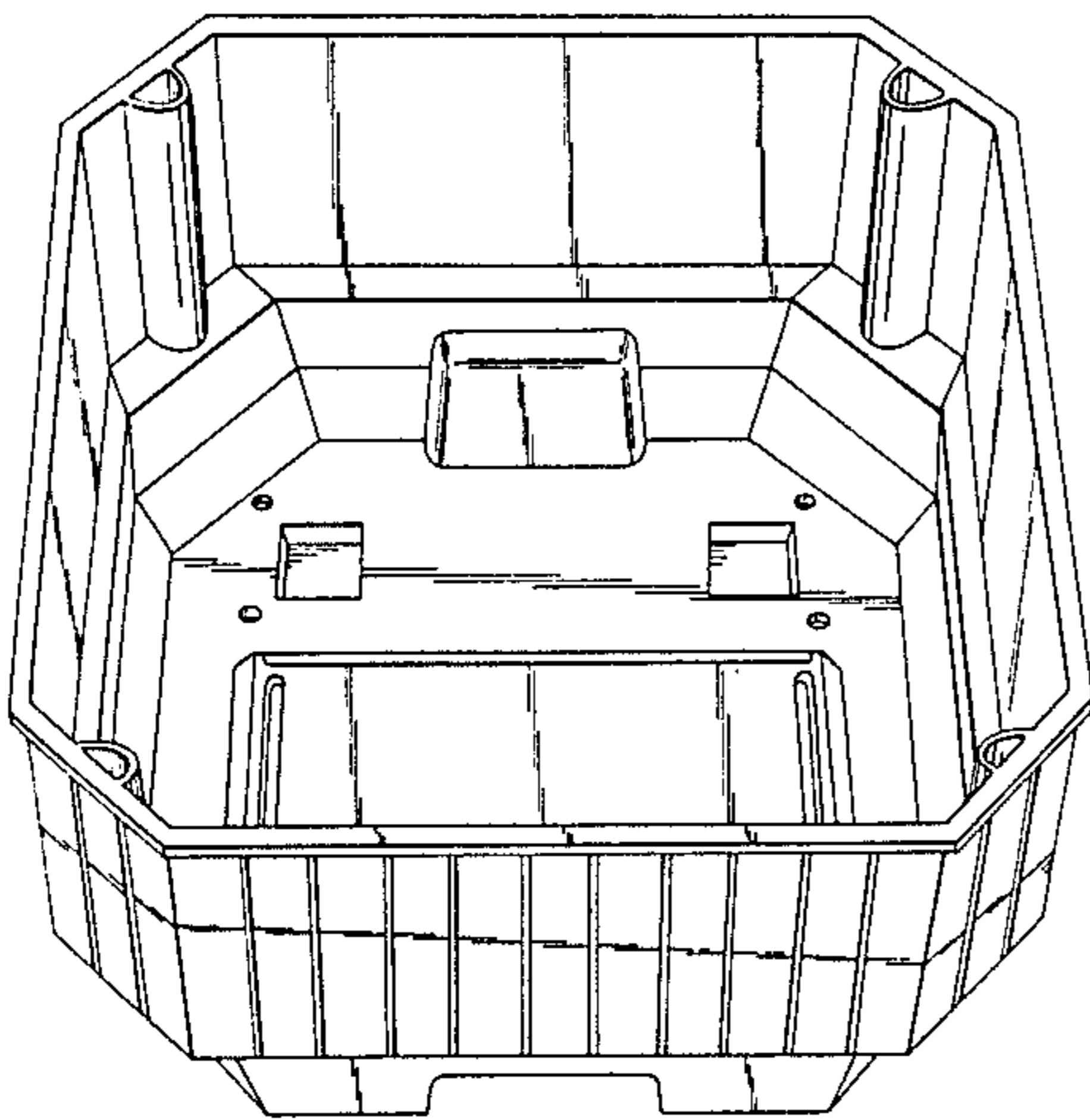
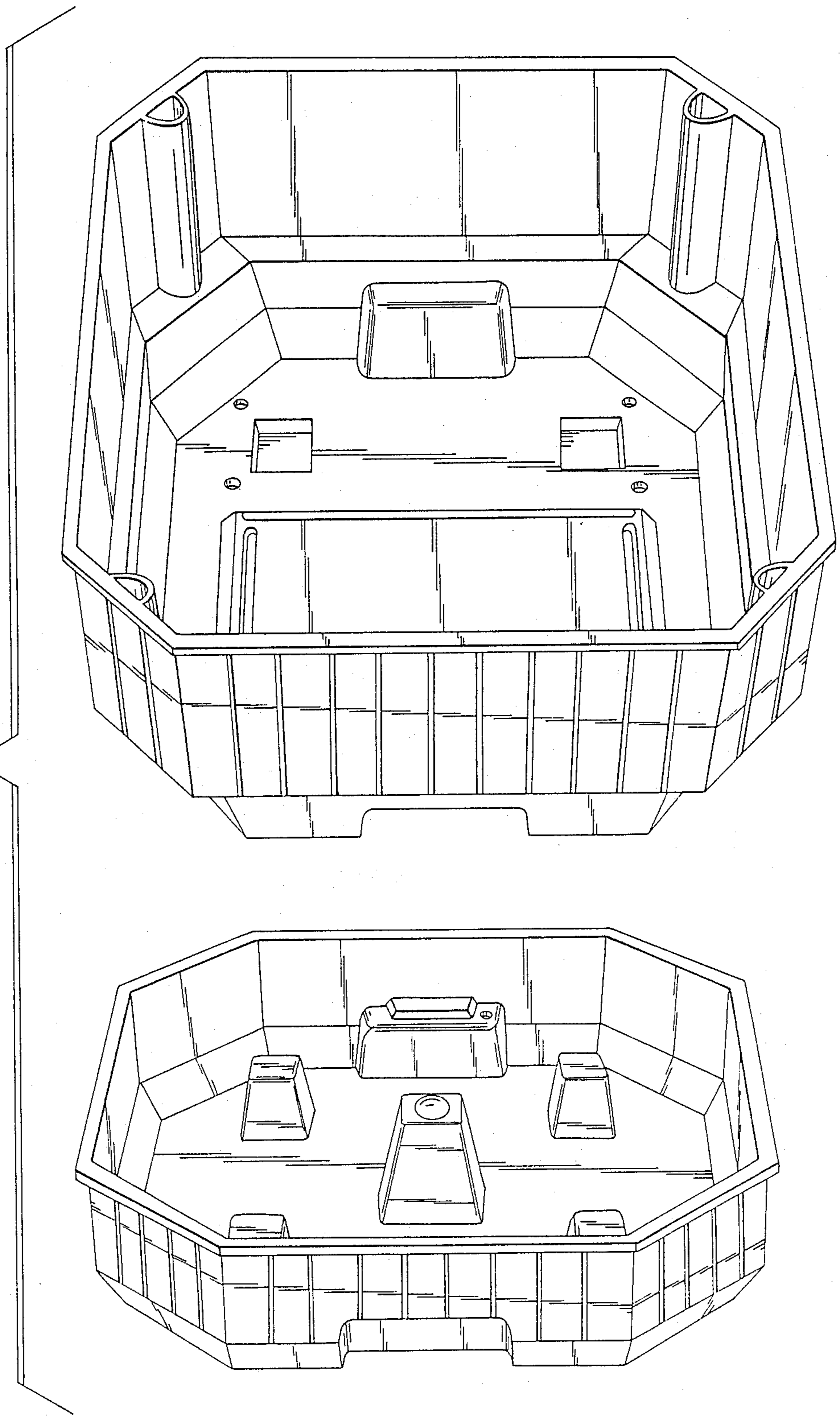

Fig. 1



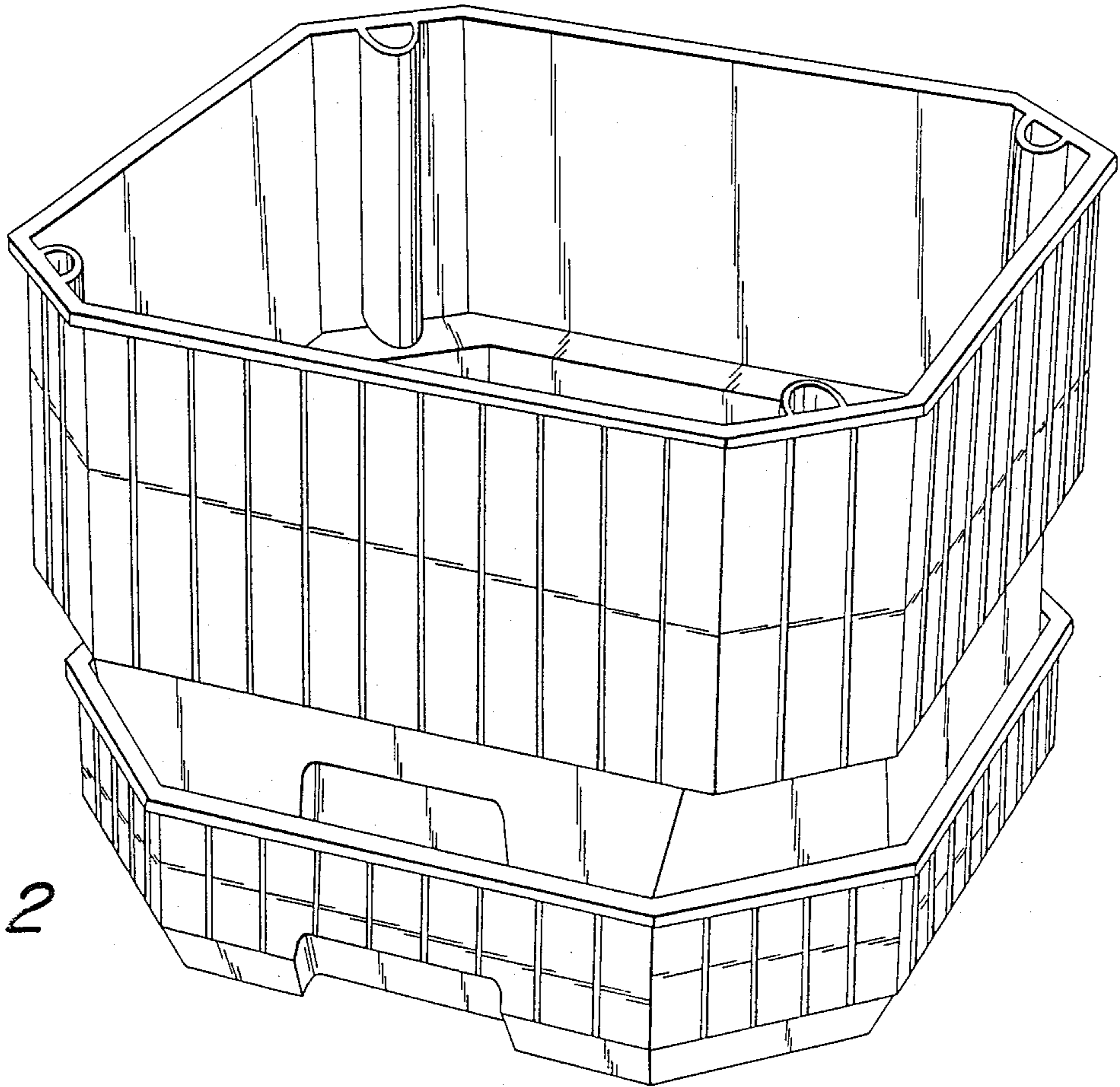

Fig. 2

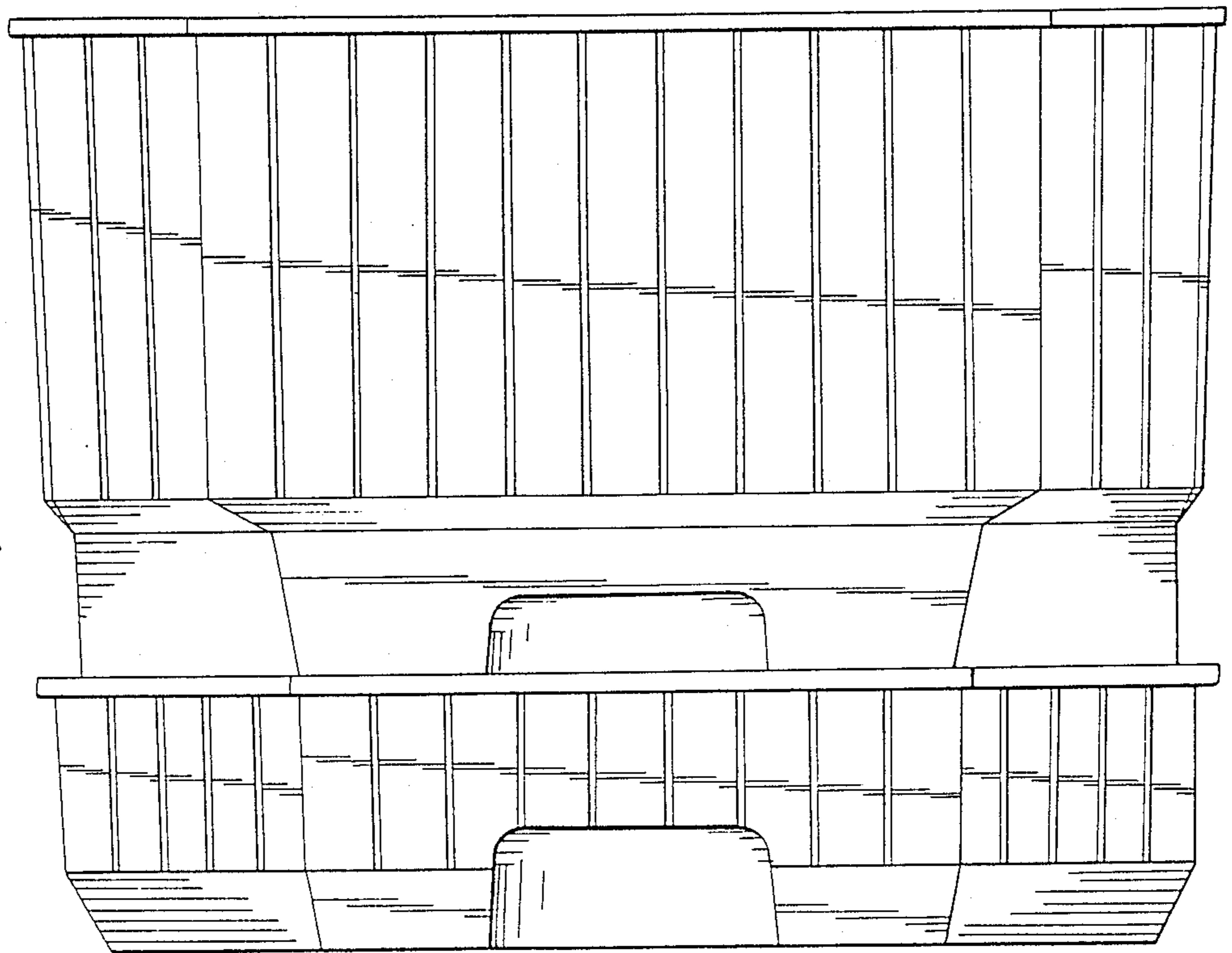

Fig. 3

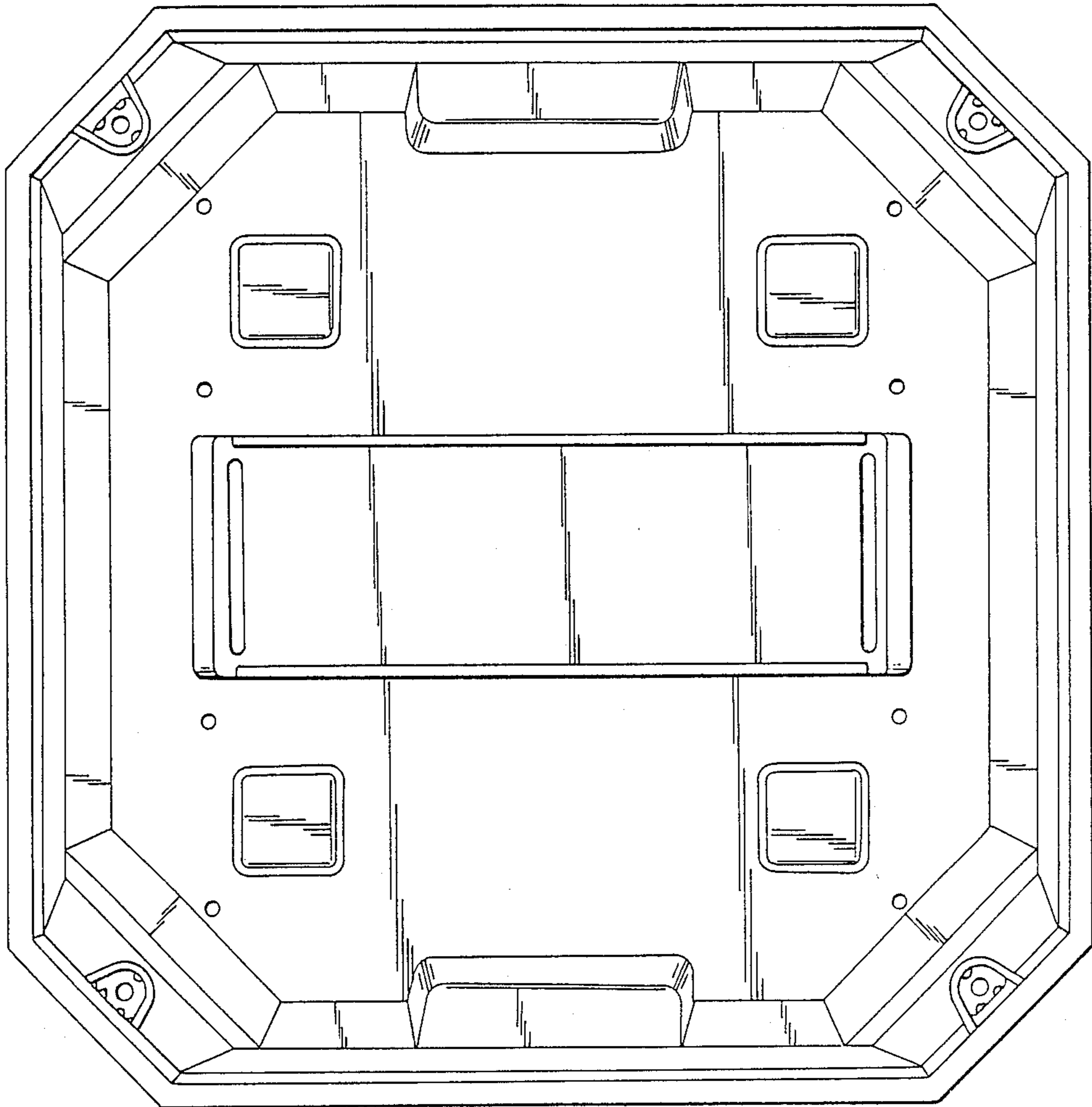

Fig. 4

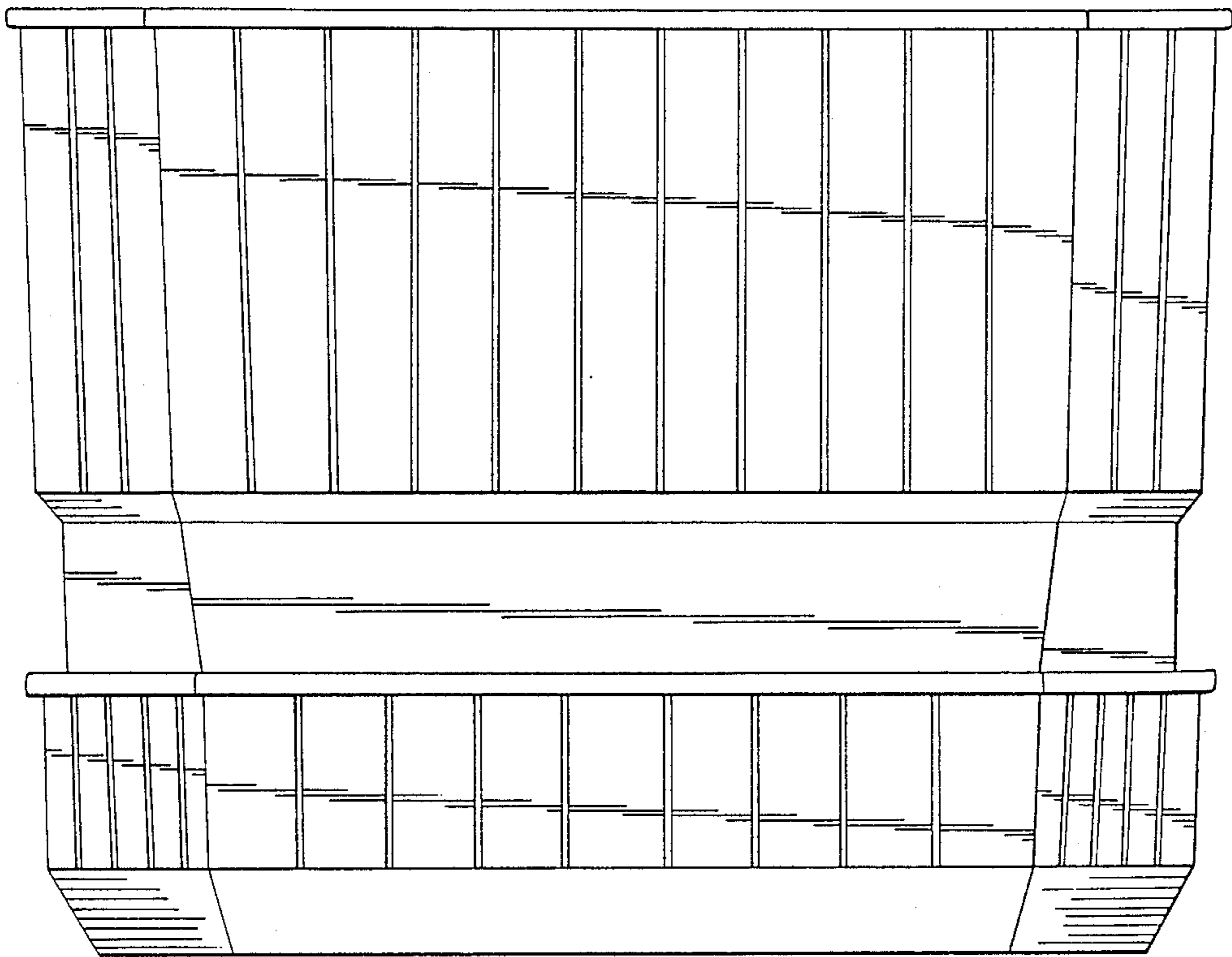

Fig. 5

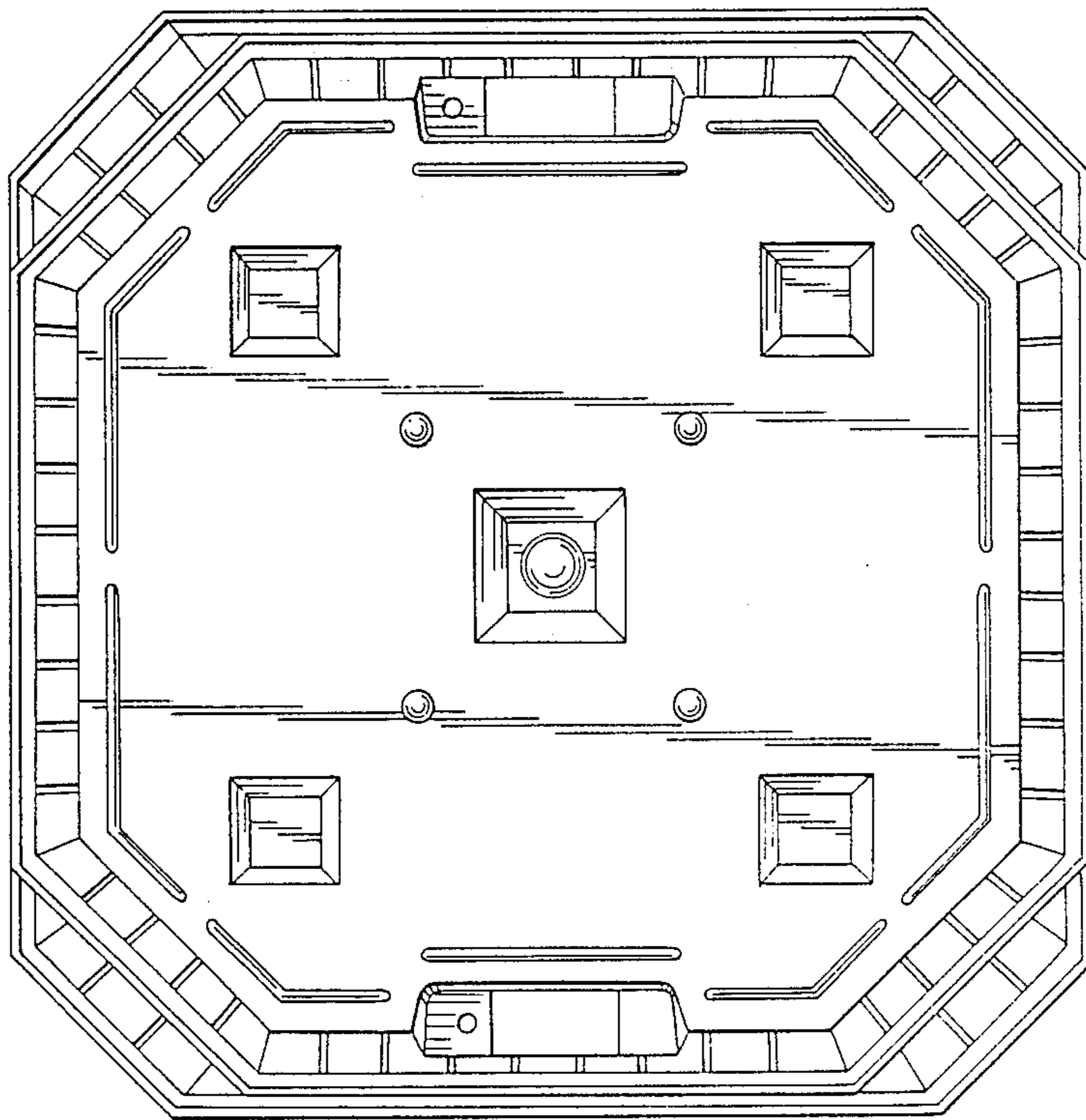

Fig. 6