

United States Patent [19]
Marks

[11] **Patent Number:** **Des. 303,204**
 [45] **Date of Patent:** **** Sep. 5, 1989**

[54] **HAND-POWERED MOTORLESS DRIVER**
 [75] **Inventor:** **Joel S. Marks, Los Angeles, Calif.**
 [73] **Assignee:** **Goldmar Manufacturing Co., Los Angeles, Calif.**
 [**] **Term:** **14 Years**
 [21] **Appl. No.:** **924,594**
 [22] **Filed:** **Oct. 28, 1986**
 [52] **U.S. Cl.** **D8/51; D8/68**
 [58] **Field of Search** **D8/14, 51, 61-70, D8/107; 81/57.11, 57.13, 57.14; 173/170; 310/50**

4,249,617 2/1981 Cox, Jr. 173/170
 4,519,527 5/1985 Klaeger D8/68 X
 4,524,650 6/1985 Marks 173/170
 4,739,838 4/1988 Marks 173/170

Primary Examiner—Bruce W. Dunkins
Assistant Examiner—Clare E. Heflin
Attorney, Agent, or Firm—Keith D. Beecher

[57] **CLAIM**

The ornamental design for a hand-powered motorless driver, as shown.

DESCRIPTION

FIG. 1 is a side elevational view of the hand-powered motorless driver showing my new design;
 FIG. 2 is an opposite side elevational view thereof;
 FIG. 3 is a top plan view thereof;
 FIG. 4 is a bottom plan view thereof;
 FIG. 5 is an end elevational view thereof;
 FIG. 6 is an opposite end elevational view thereof; and
 FIG. 7 is a reduced front perspective view thereof.

[56] **References Cited**
U.S. PATENT DOCUMENTS
 D. 136,891 12/1943 Kost D8/68
 D. 229,604 2/1973 LaPointe D8/68
 D. 256,658 9/1980 Ewig D8/61

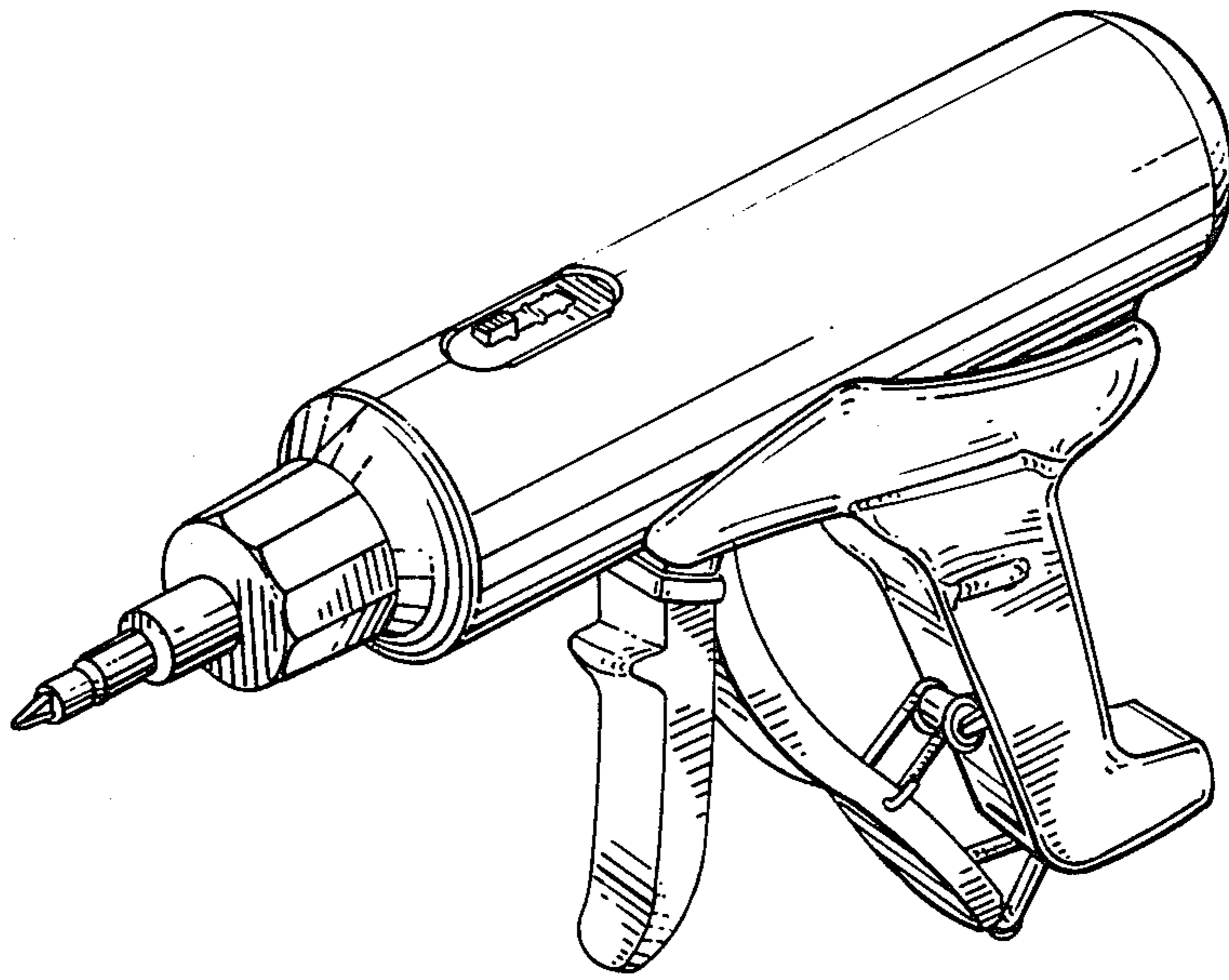

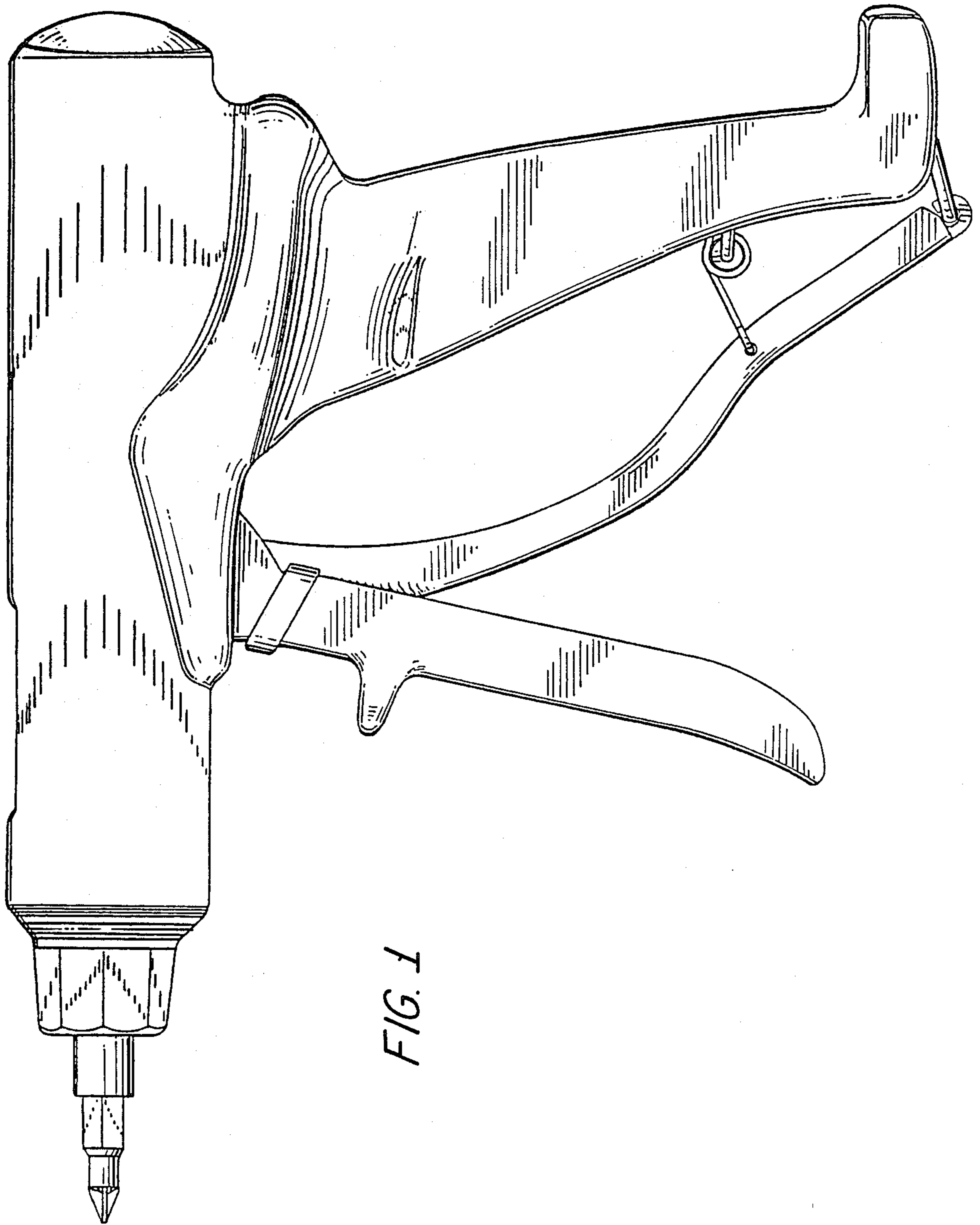
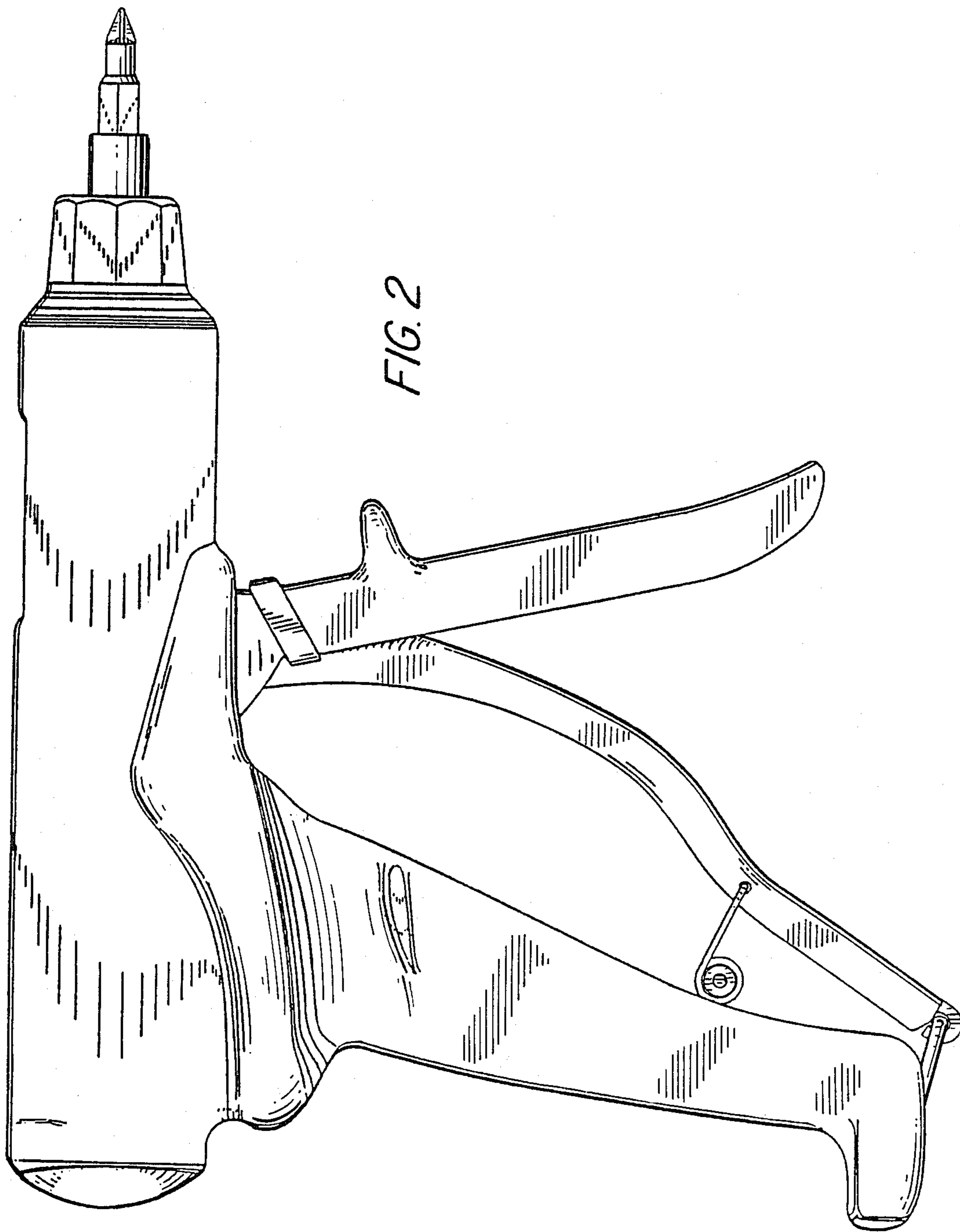

FIG. 1



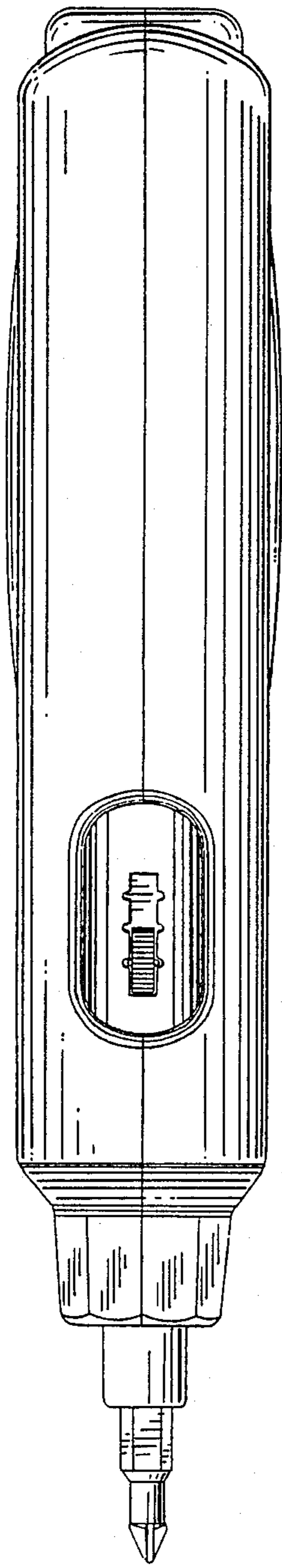

FIG. 3

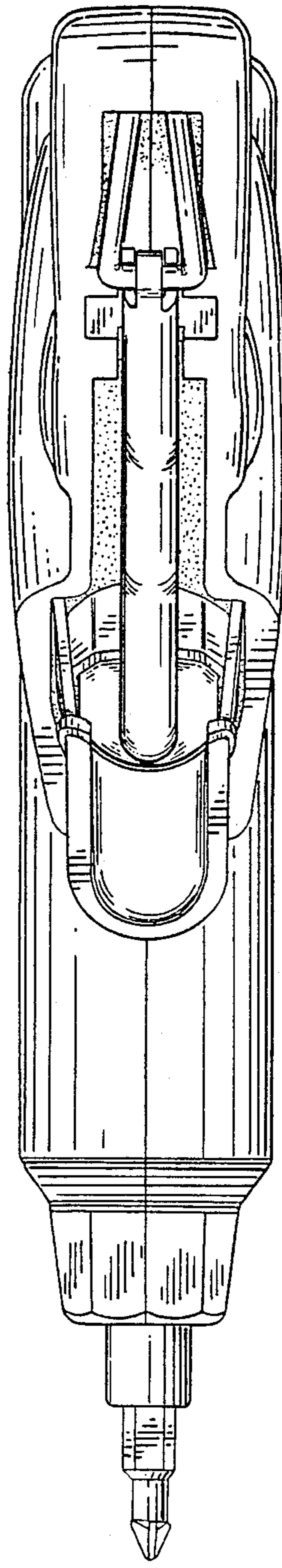

FIG. 4

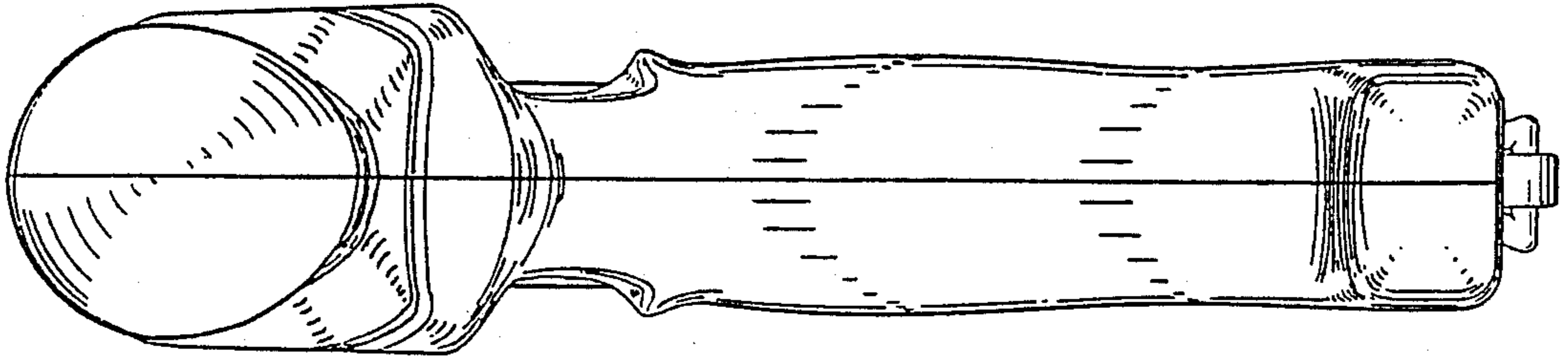

FIG. 6

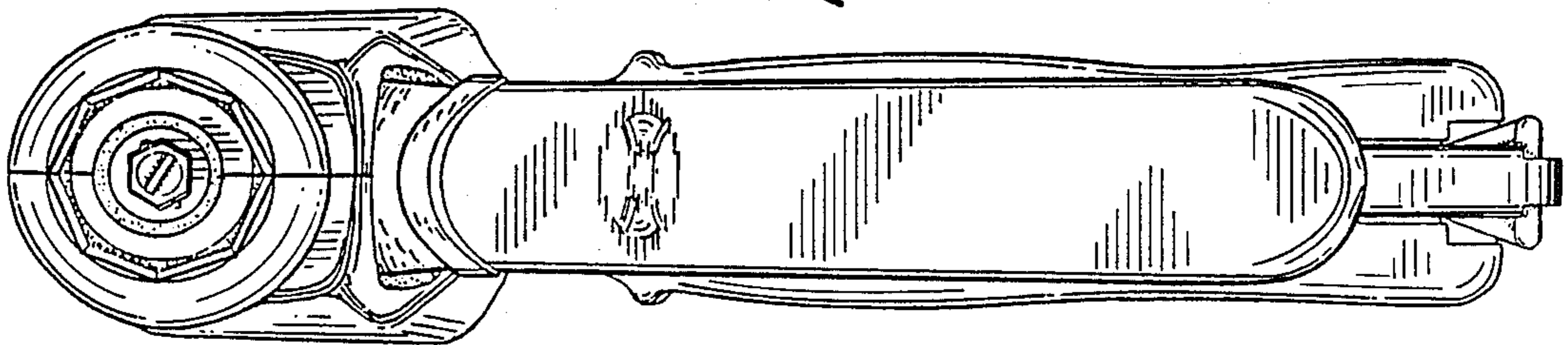

FIG. 5

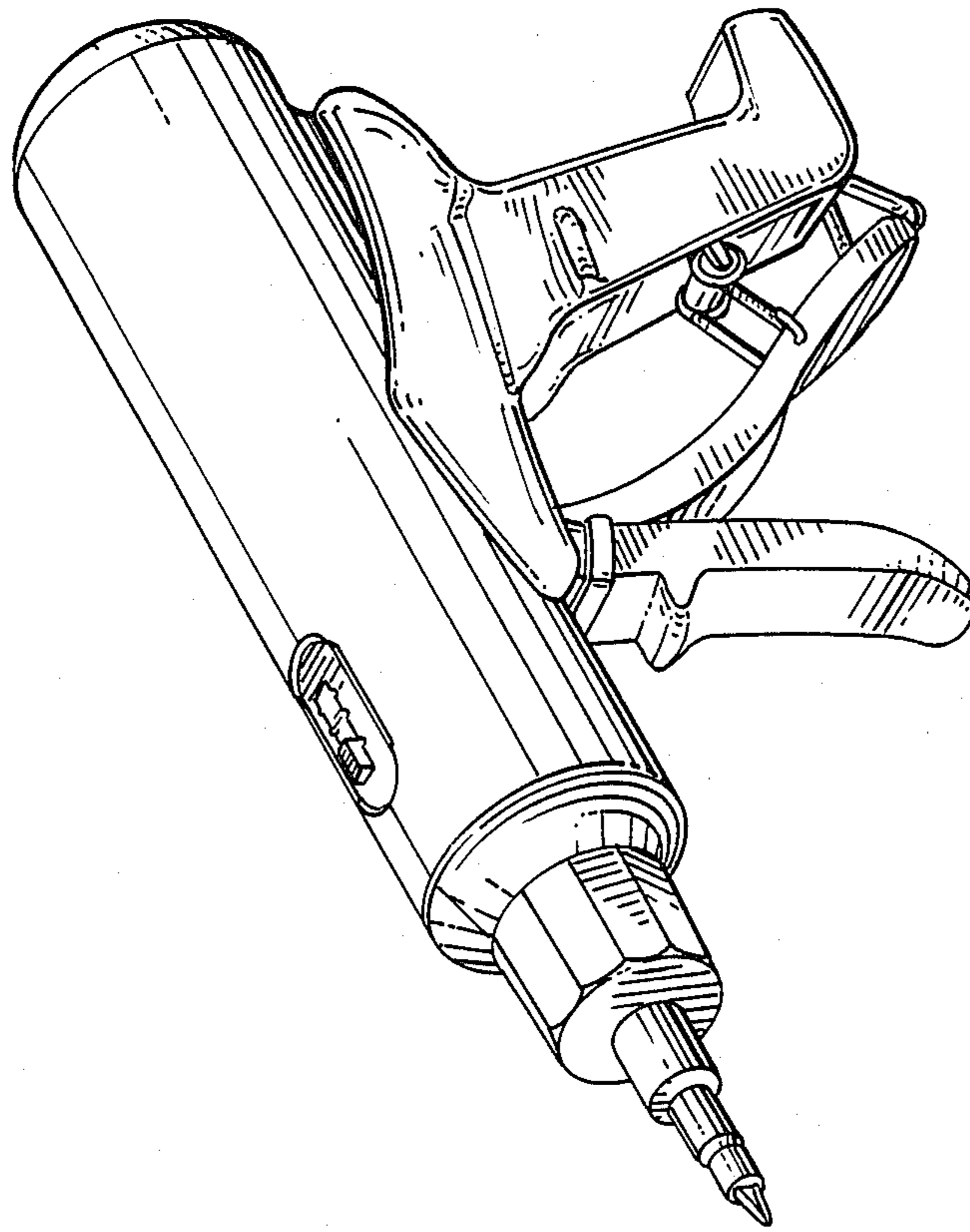

FIG. 7