

[54] PICTURE FRAME

[75] Inventor: Mel Evenson, San Pedro, Calif.

[73] Assignee: Eldon Industries, Inc., Inglewood, Calif.

[**] Term: 14 Years

[21] Appl. No.: 944,533

[22] Filed: Dec. 22, 1986

[52] U.S. Cl. D6/301; D6/309; D6/310

[58] Field of Search D6/300, 301, 309, 310; 40/152, 152.1, 155

[56] References Cited

U.S. PATENT DOCUMENTS

D. 255,198	6/1980	Mersch	D6/314
D. 280,150	8/1985	Pargman	D6/300
D. 282,024	1/1986	Muranen	D6/300
2,616,197	11/1952	Osburn	40/152
4,258,489	3/1981	Maguire	40/152.1
4,726,133	2/1988	Rainone et al.	40/152.1

Primary Examiner—B. J. Bullock
Attorney, Agent, or Firm—Edward D. O'Brian

[57] CLAIM

The ornamental design for a picture frame, as shown and described.

DESCRIPTION

FIG. 1 is a front elevational view of a picture frame showing my design;
 FIG. 2 is a rear elevational view thereof;
 FIG. 3 is a top plan view thereof;
 FIG. 4 is a bottom plan view thereof;
 FIG. 5 is a side elevational view of the right side thereof, the left side thereof being a mirror image of this view;
 FIG. 6 is a front elevational view of a second embodiment of the design of FIG. 1, the only difference being its horizontal orientation and the size and location of the base;
 FIG. 7 is a front elevational view of a third embodiment of the design of FIG. 1;
 FIG. 8 is a rear elevational view of FIG. 7;
 FIG. 9 is a side elevational view of the right side of FIG. 7, the left side elevational view thereof being a mirror image of this view;
 FIG. 10 is a top plan view of FIG. 7;
 FIG. 11 is a bottom plan view of FIG. 7.

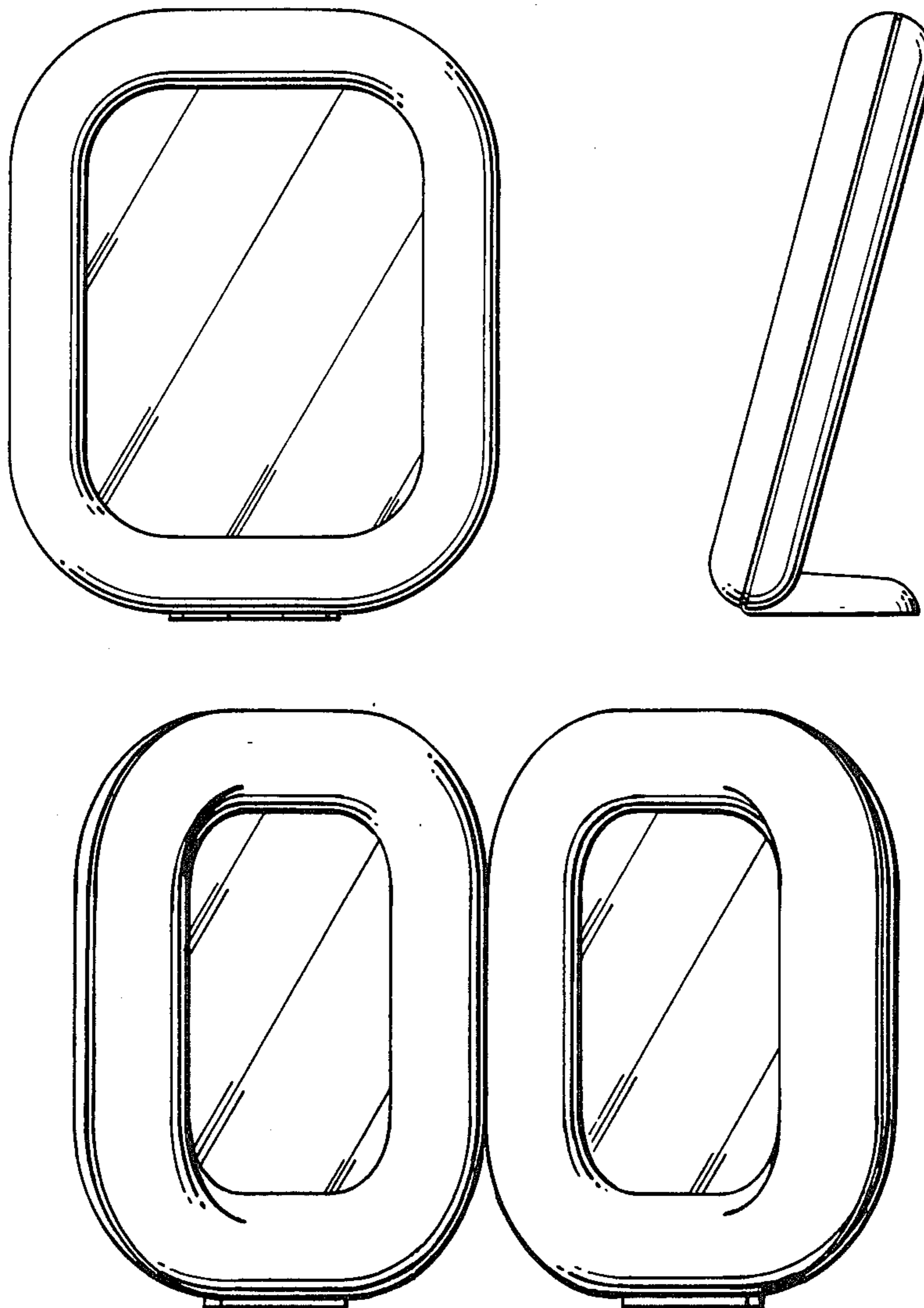

FIG. 1.

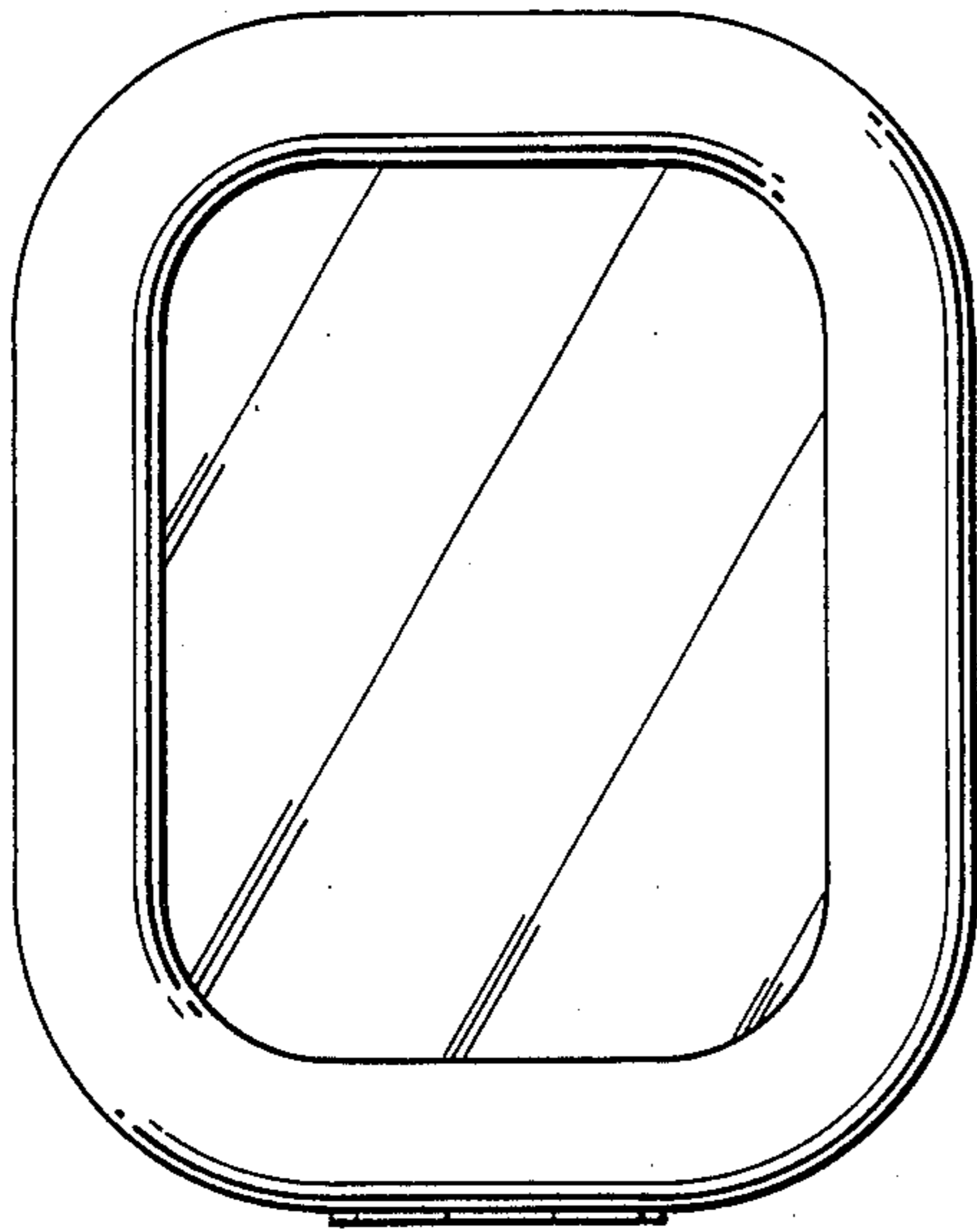

FIG. 2.

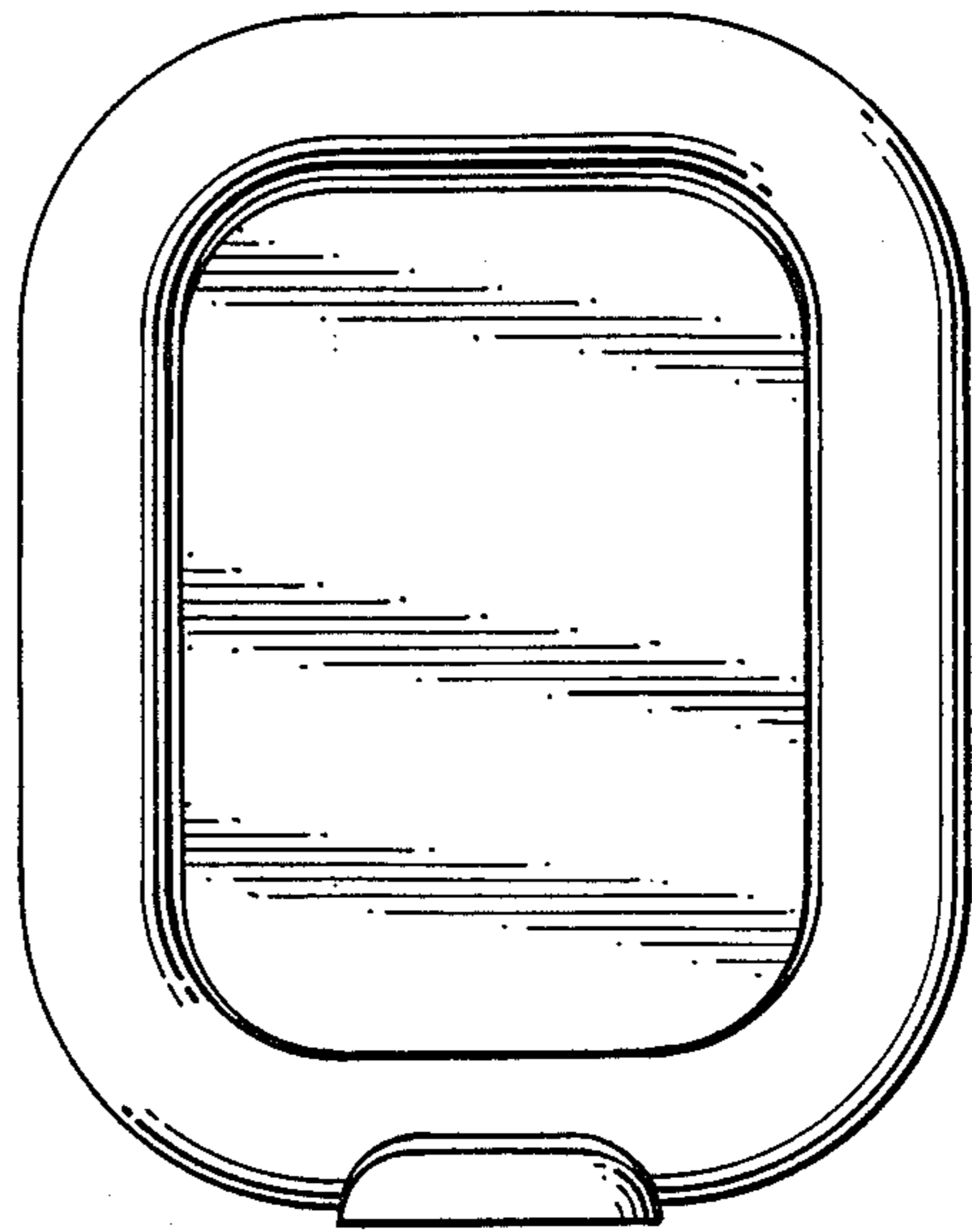

FIG. 3.

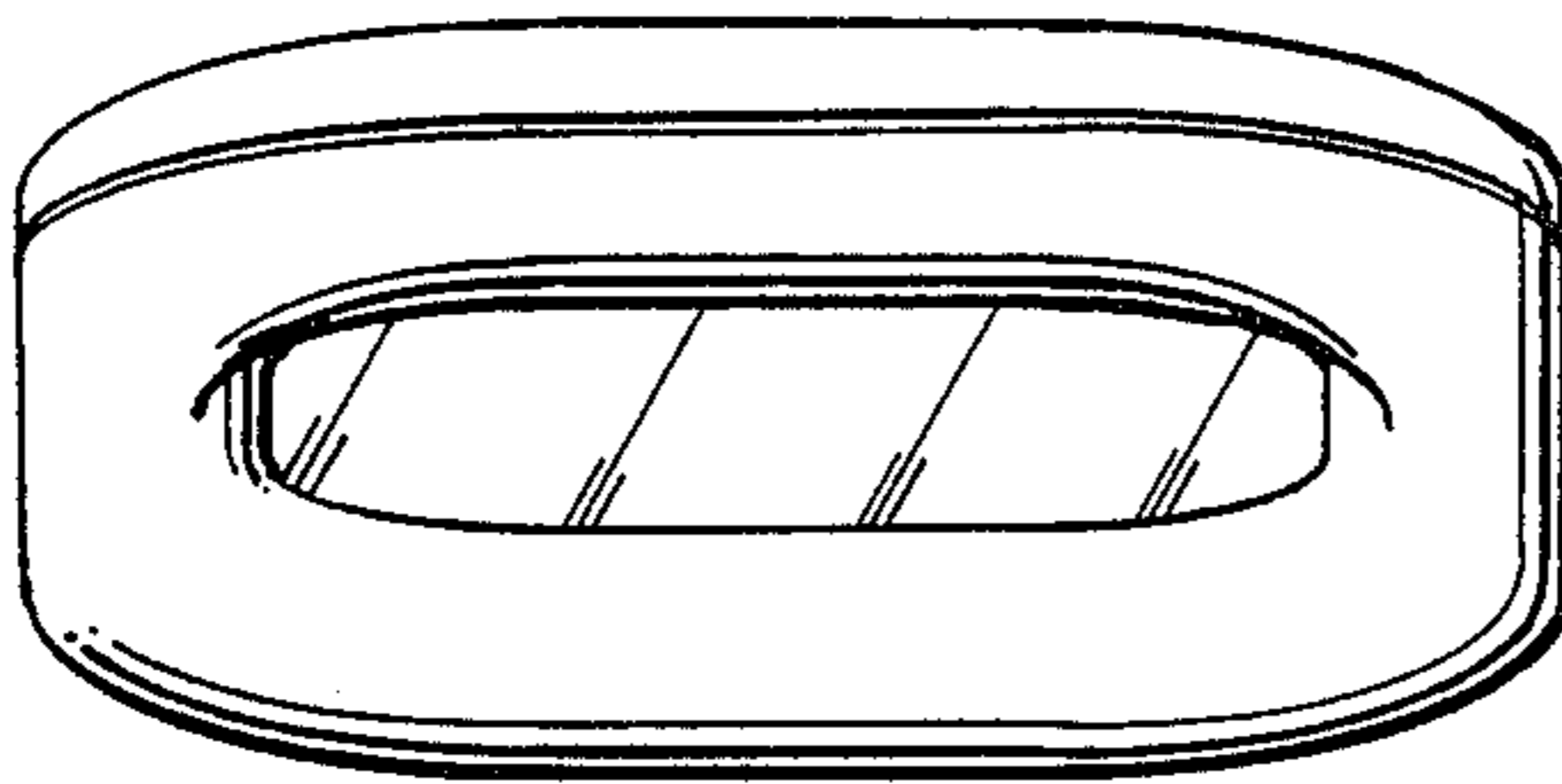

FIG. 4.

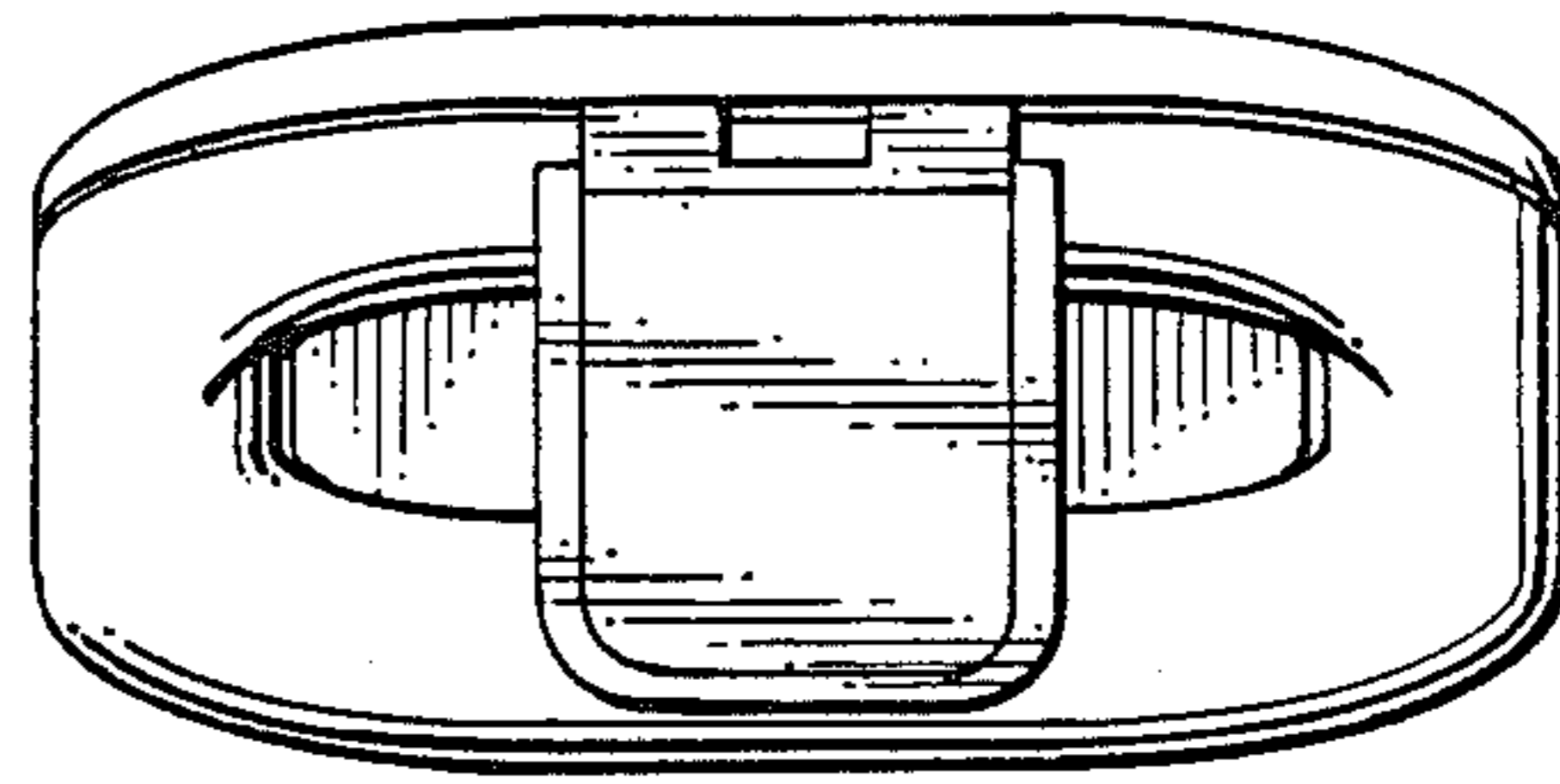

FIG. 5.

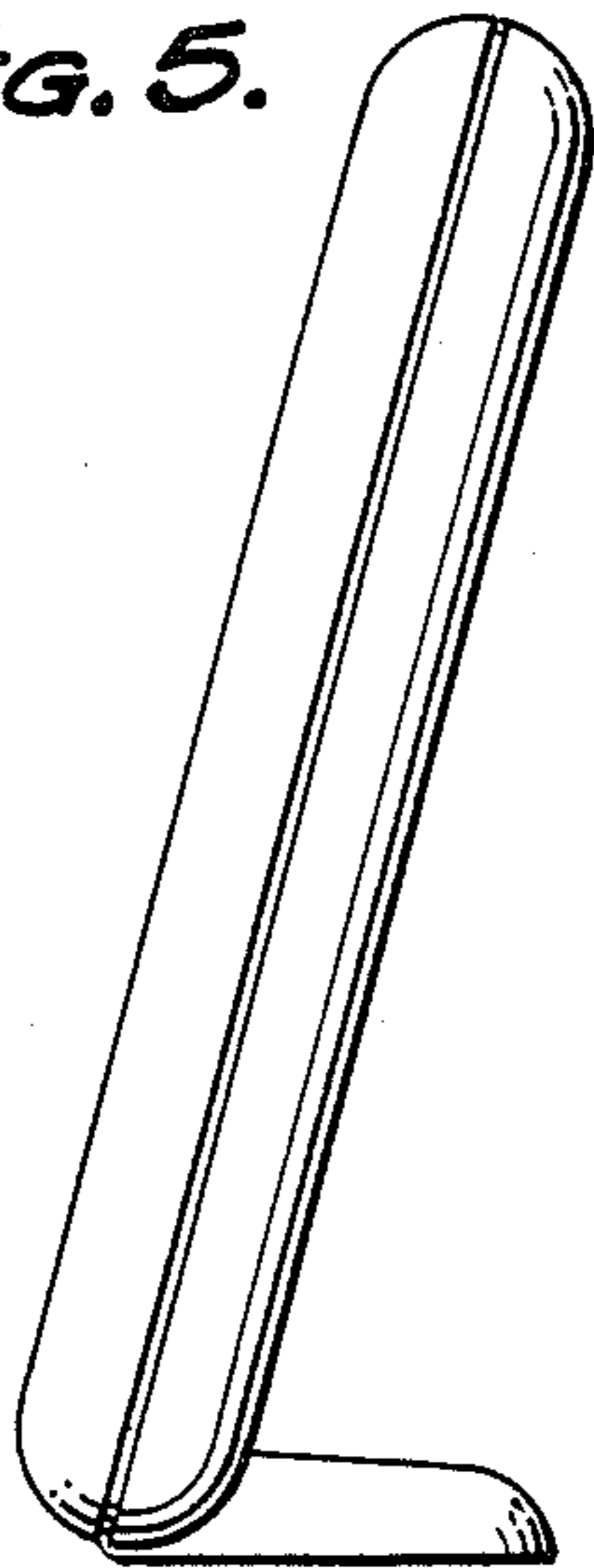

FIG. 6.

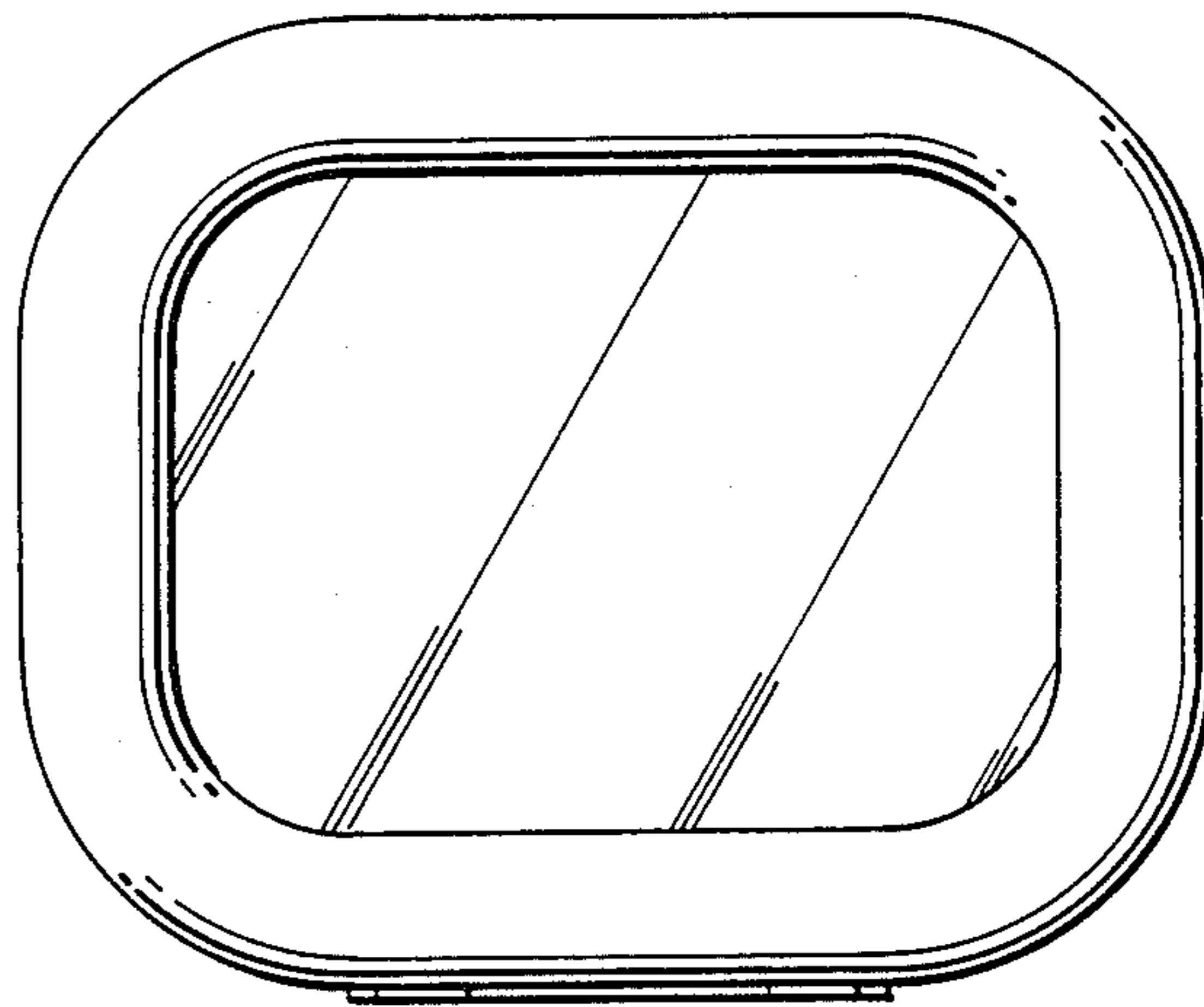

FIG. 7.

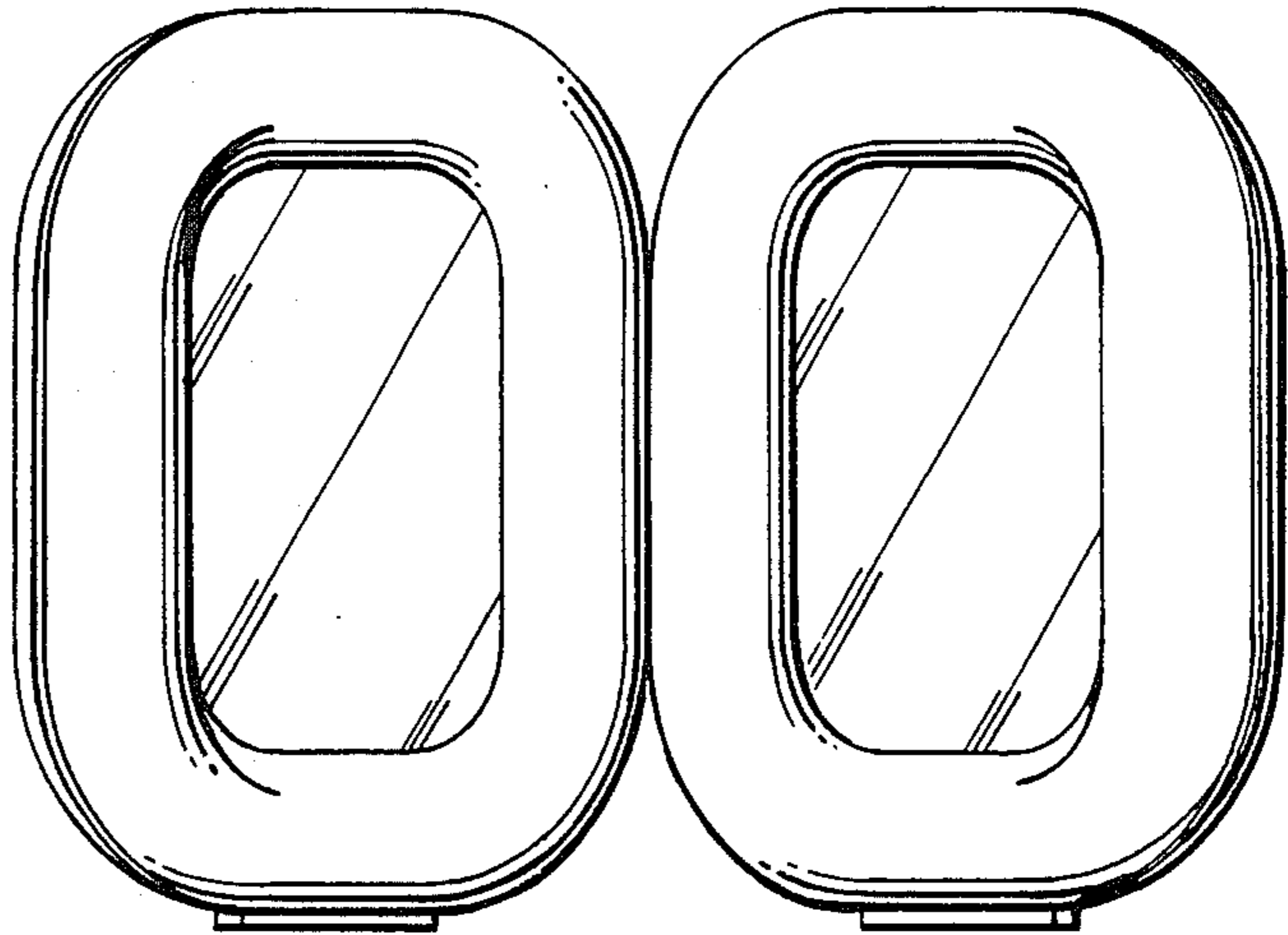

FIG. 8.

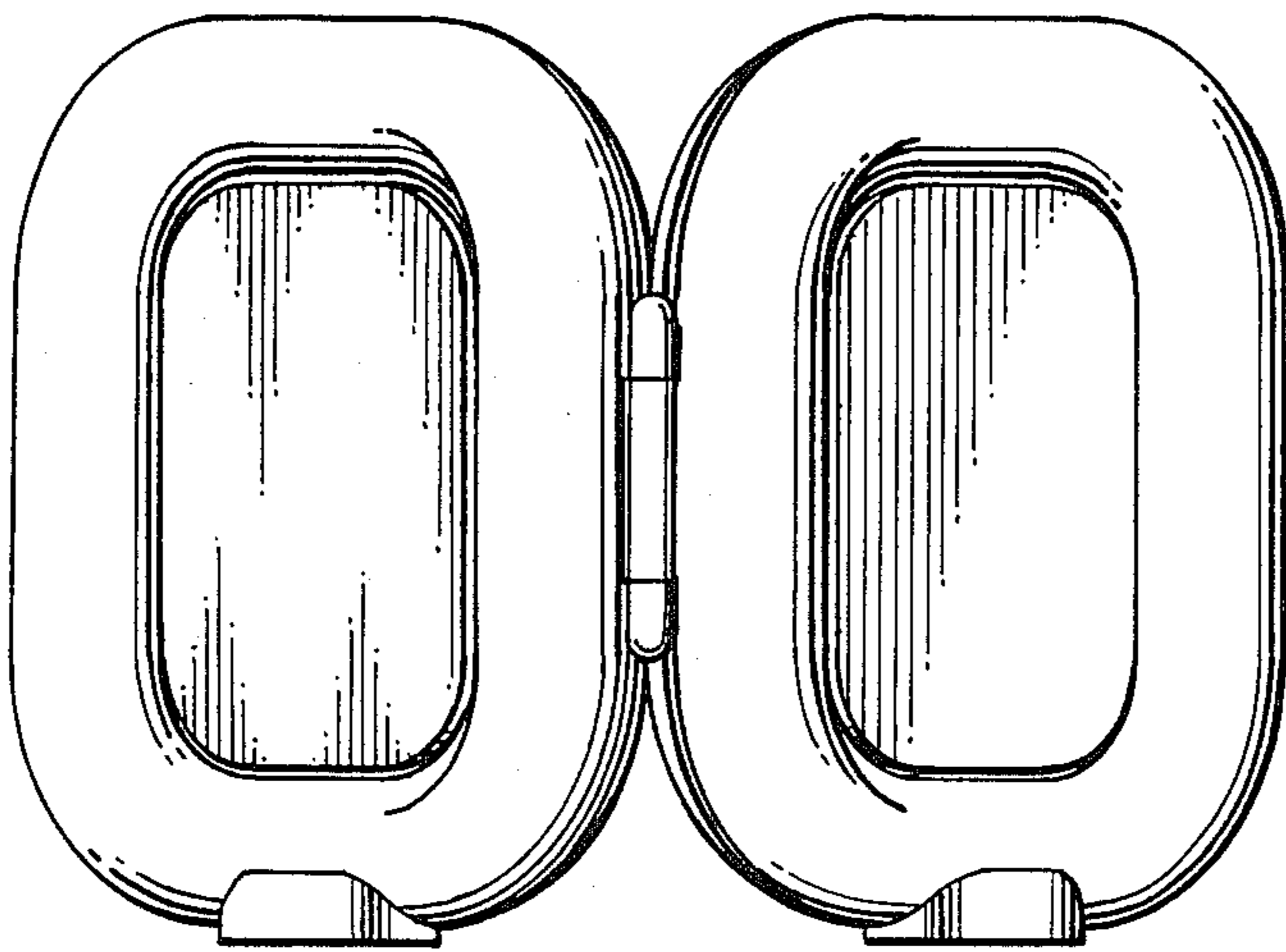

FIG. 9.

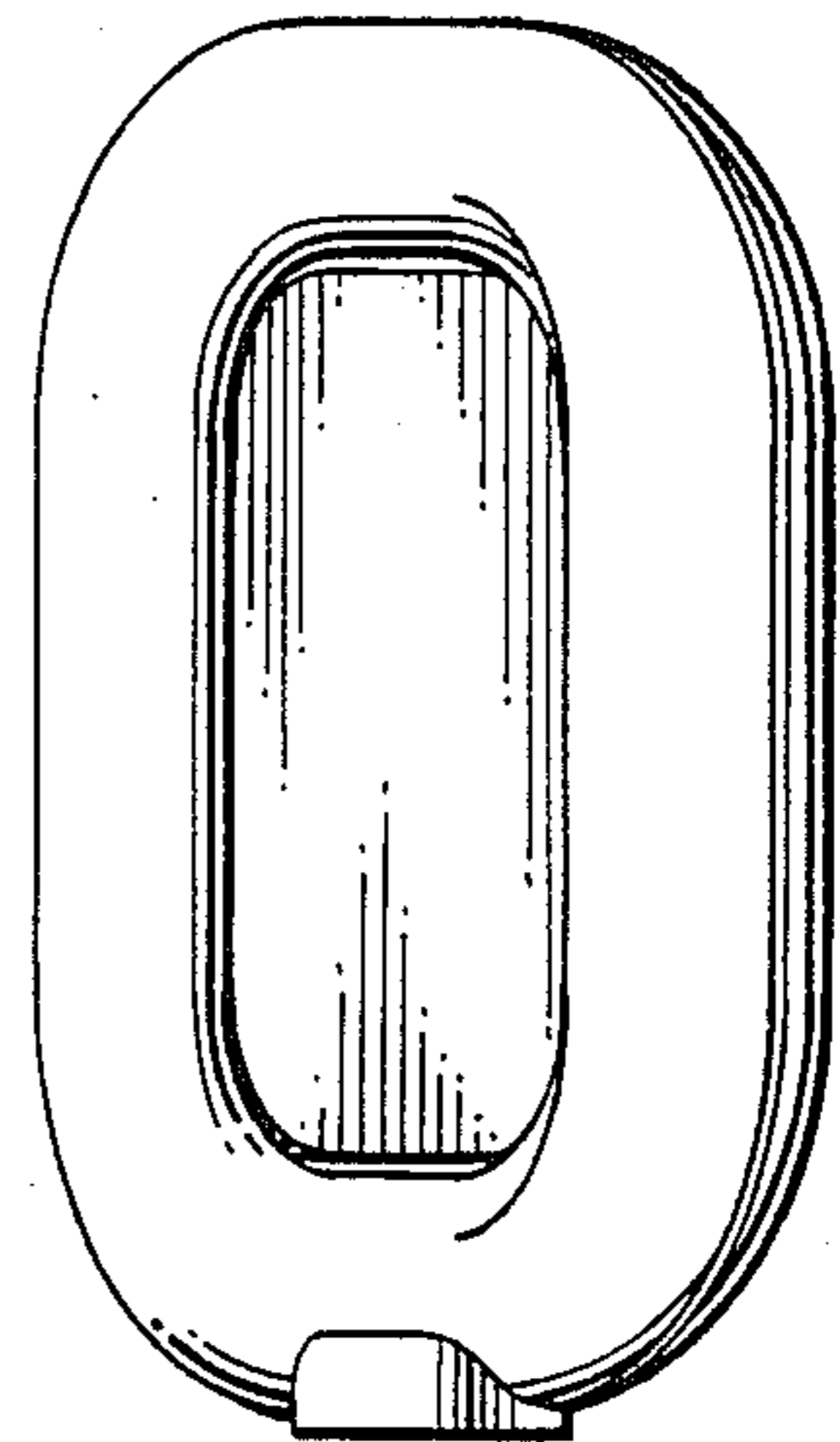

FIG. 10.

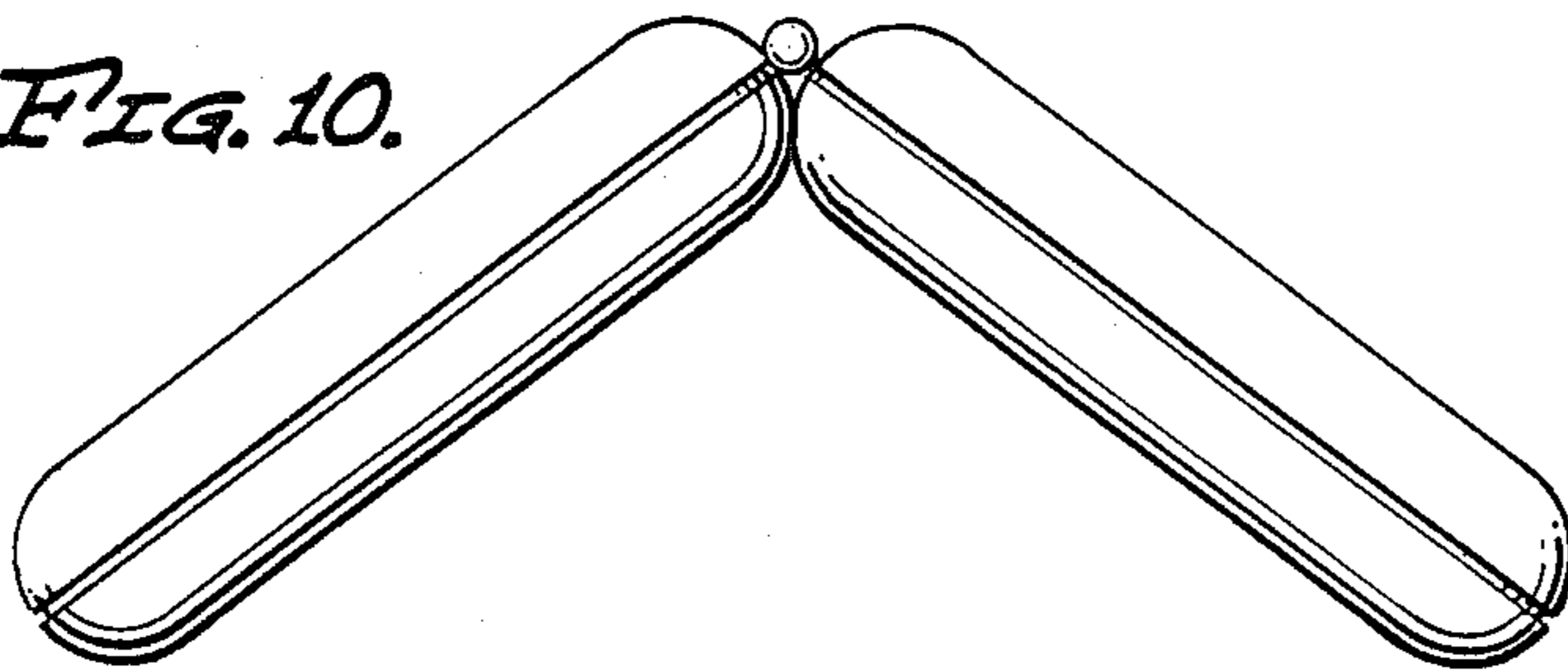

FIG. 11.

