

[54] HANDLE

[75] Inventors: Renato P. Castelli, Gent; Willibald J. Van Hoyer, Zwijnaarde, both of Belgium; Richard Miles, Crowborough; Wendy Flicker, Surrey, both of England

[73] Assignee: Samsonite Corporation, Denver, Colo.

[**] Term: 14 Years

[21] Appl. No.: 858,296

[22] Filed: Apr. 30, 1986

[30] Foreign Application Priority Data

Oct. 31, 1985 [GB] United Kingdom 1030153
[52] U.S. Cl. D8/306
[58] Field of Search D8/300, 306, 307; D3/37, 72, 73, 76, 77; 150/110; 190/39, 115, 116, 117, 118; 16/110 R, 116 R, 125, 126

[56]

References Cited

U.S. PATENT DOCUMENTS

Table with 4 columns: Patent No., Date, Inventor, and Class. Includes entries for Avé et al., Miles et al., Null, Castelli, Seynhaeve, and Winter et al.

Primary Examiner—B. J. Bullock
Attorney, Agent, or Firm—Gregory W. O'Connor

[57]

CLAIM

The ornamental design for a handle, as shown and described.

DESCRIPTION

FIG. 1 is a perspective view of a handle, showing our new design;
FIG. 2 is a perspective view thereof, showing the handle in operative position;
FIG. 3 is a side elevational view thereof, showing the side opposite that shown in FIG. 1;
FIG. 4 is a side elevational view thereof, showing the side shown in FIG. 1;
FIG. 5 is a rear elevational view thereof;
FIG. 6 is a plan view of FIG. 5 as viewed from above;
FIG. 7 is a plan view of FIG. 1 as viewed from below.

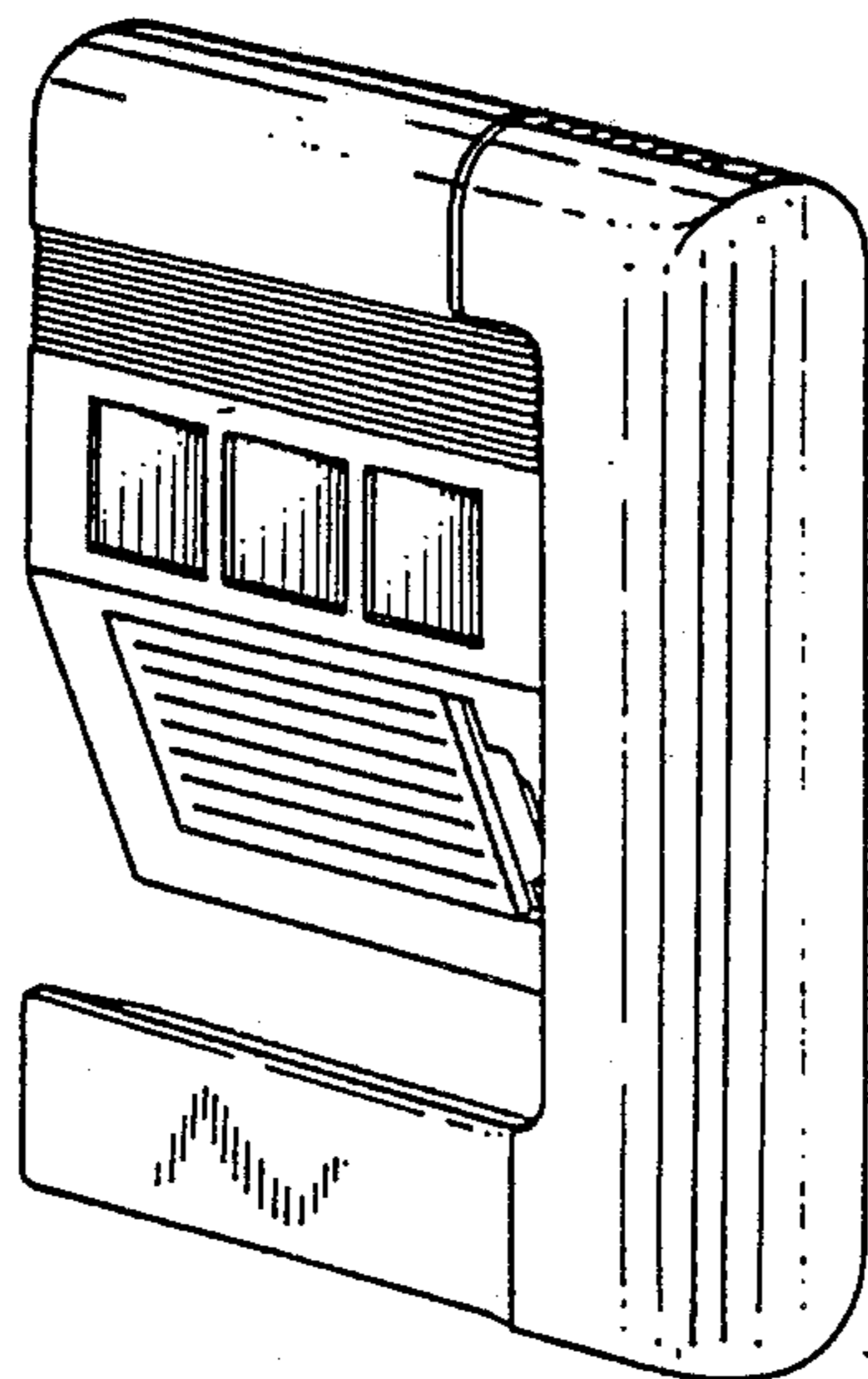

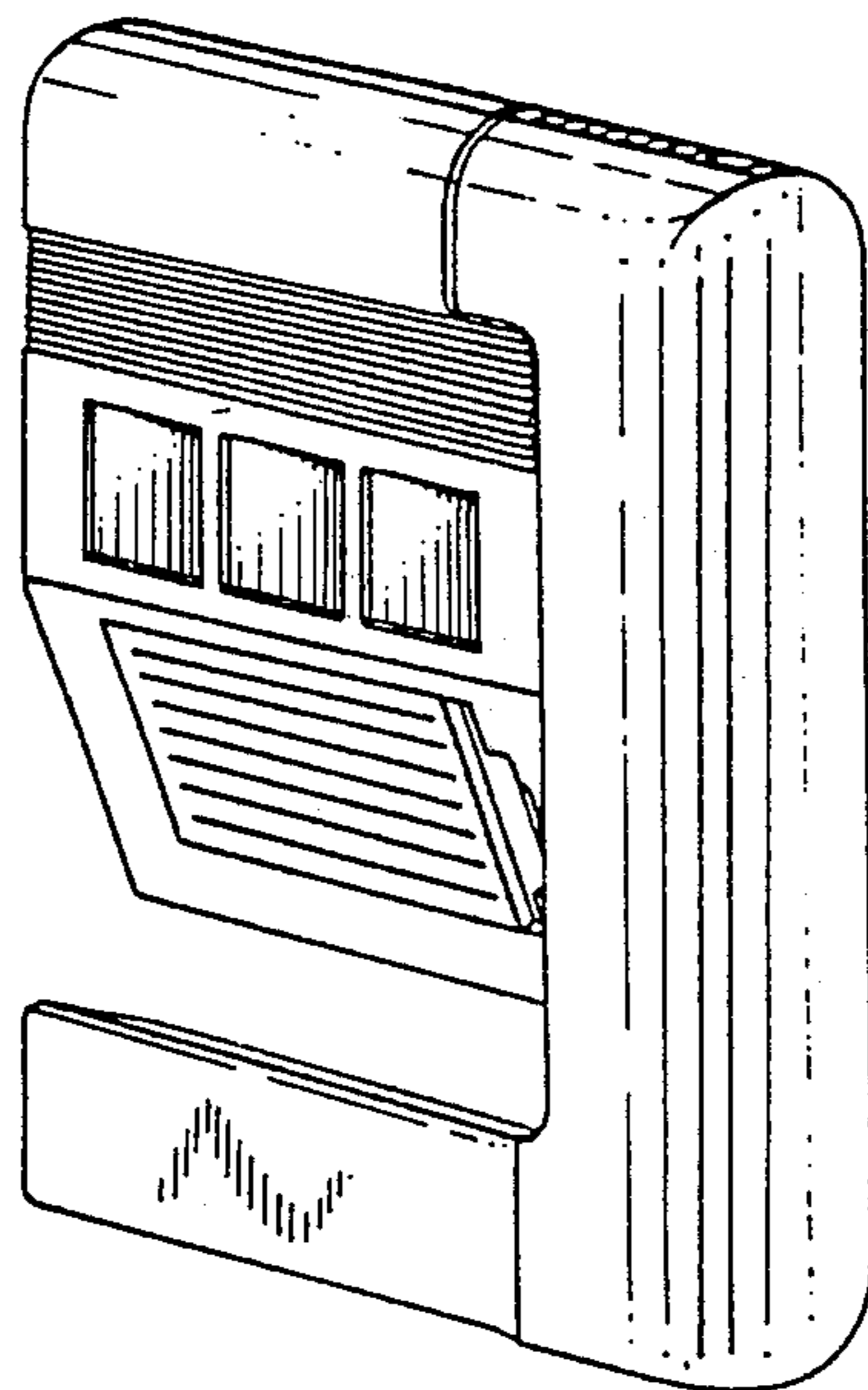

FIG. 1

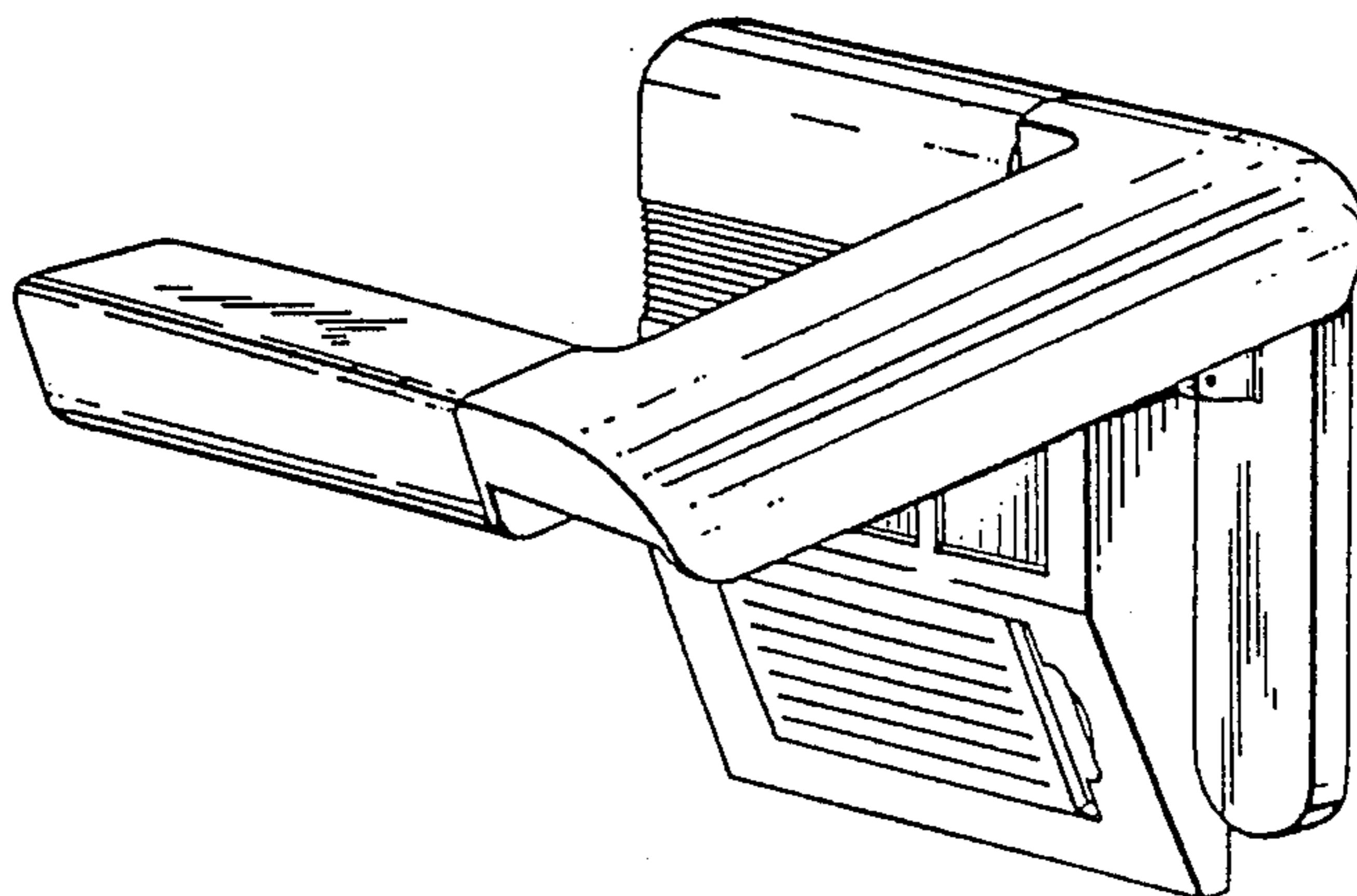

FIG. 2



FIG. 3

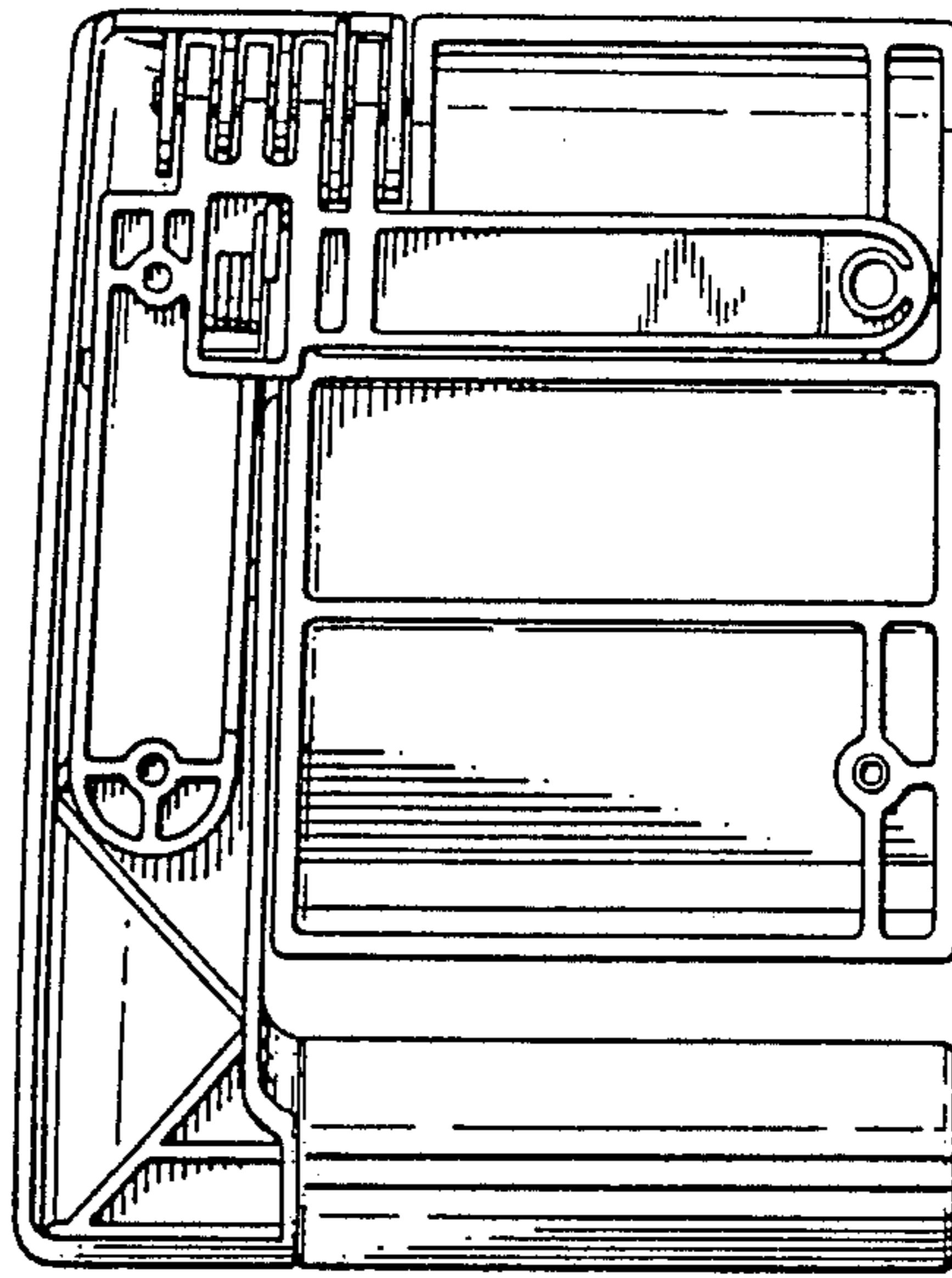

FIG. 5

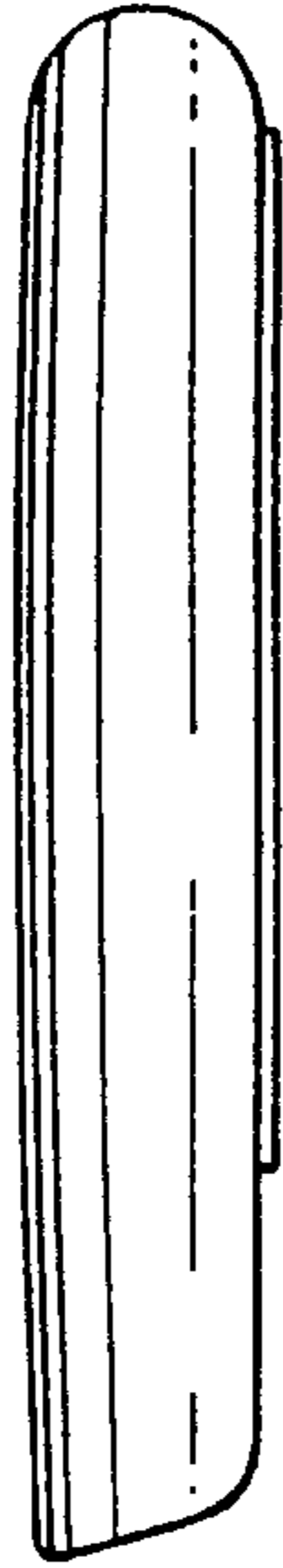

FIG. 4

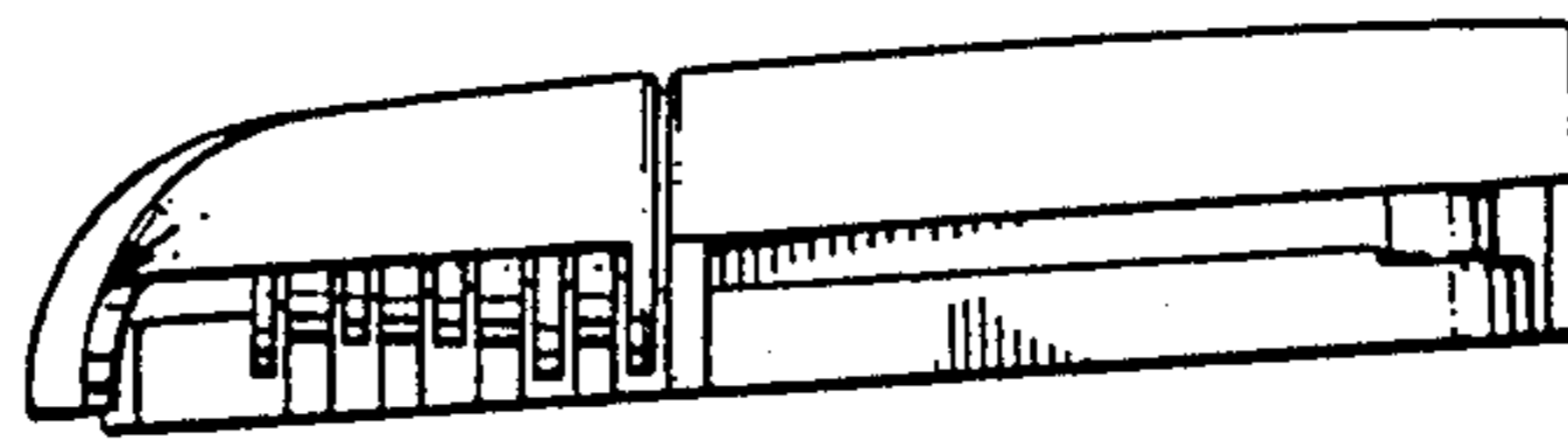

FIG. 6

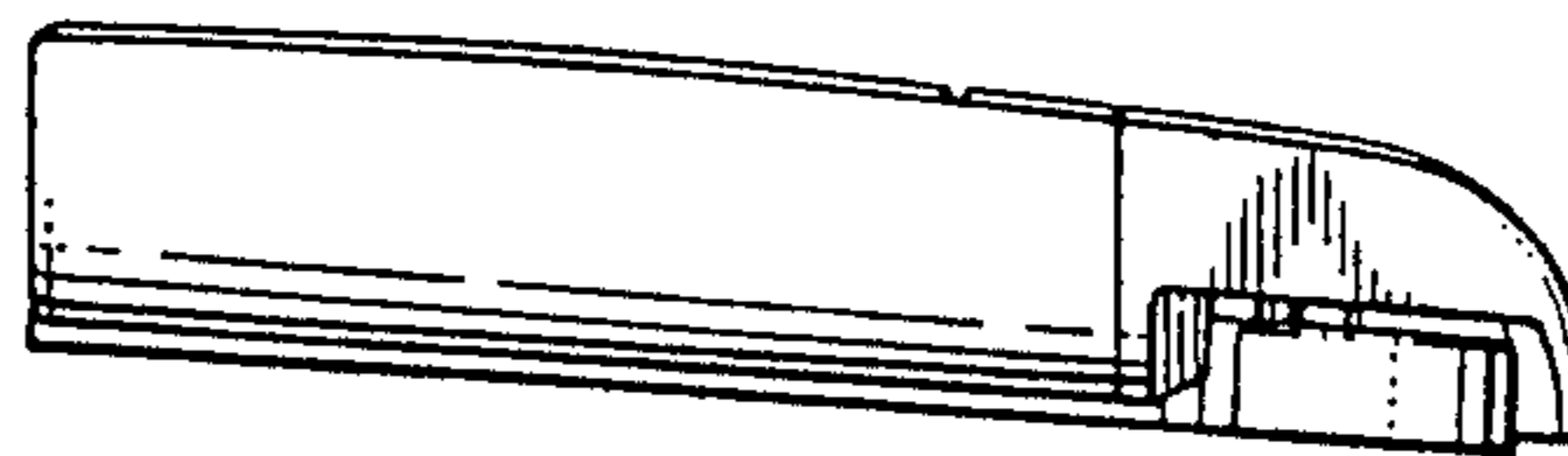

FIG. 7