

[54] CAN OPENER

[75] Inventors: Jane Ancona; Bruce Ancona, both of New York, N.Y.

[73] Assignee: M. Kamenstein, Inc., White Plains, N.Y.

[**] Term: 14 Years

[21] Appl. No.: 290,087

[22] Filed: Dec. 23, 1989

[52] U.S. Cl. D8/39

[58] Field of Search D8/33, 34, 38-41, D8/43; 30/416, 426-427, 401, 409, 421-425

[56] References Cited

U.S. PATENT DOCUMENTS

- D. 266,979 11/1982 Steiner et al. D8/39
- D. 282,521 2/1986 Steinko D8/39

OTHER PUBLICATIONS

Hong Kong Enterprise, 9/80, p. 126, Can Opener, bottom left corner.

Primary Examiner—Bernard Ansher
Assistant Examiner—Terry A. Pfeffer
Attorney, Agent, or Firm—Henry R. Lerner

[57] CLAIM

The ornamental design for a can opener, as shown.

DESCRIPTION

FIG. 1 is a front perspective view of a can opener showing our new design;
 FIG. 2 is a top plan view thereof;
 FIG. 3 is a bottom plan view thereof;
 FIG. 4 is a front elevational view thereof;
 FIG. 5 is a right side elevational view thereof;
 FIG. 6 is a left side elevational view thereof; and
 FIG. 7 is a rear elevational view thereof.

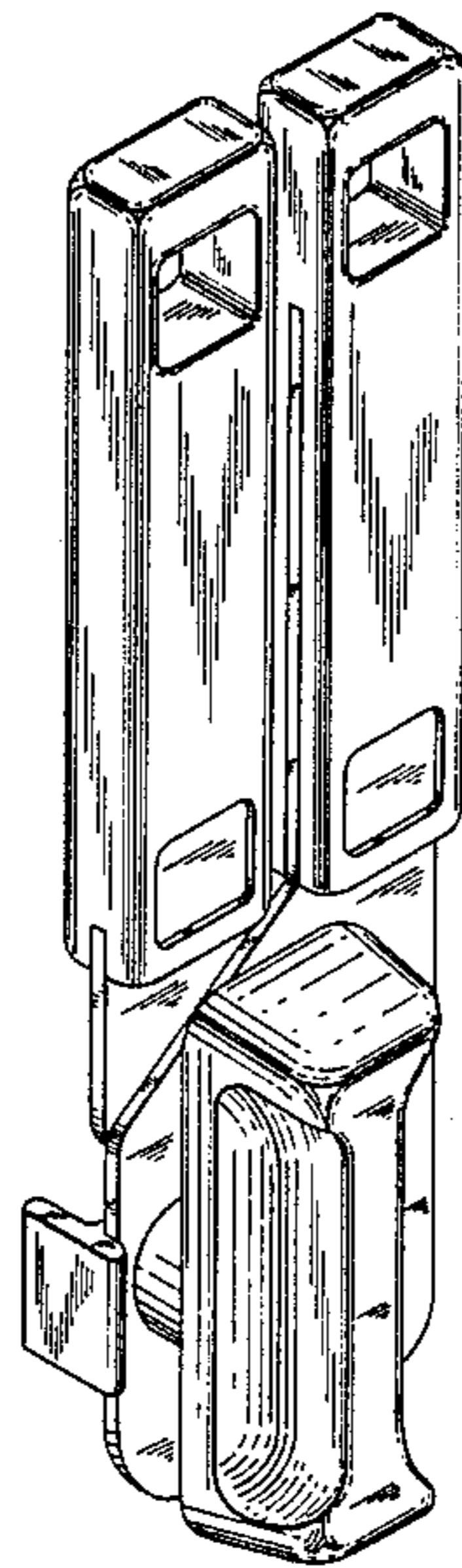

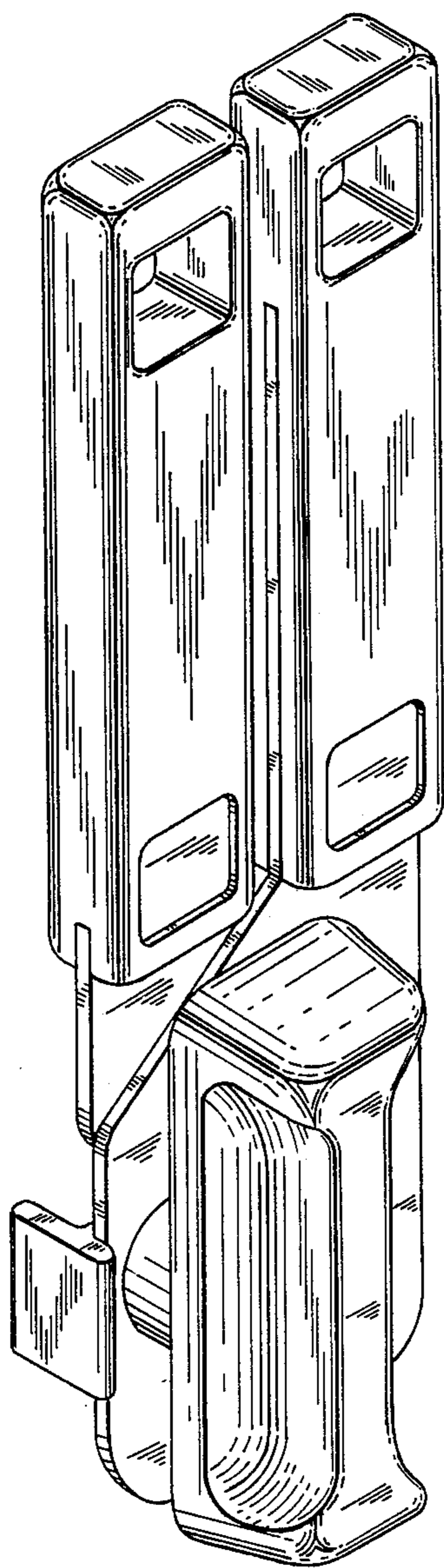

FIG. 1

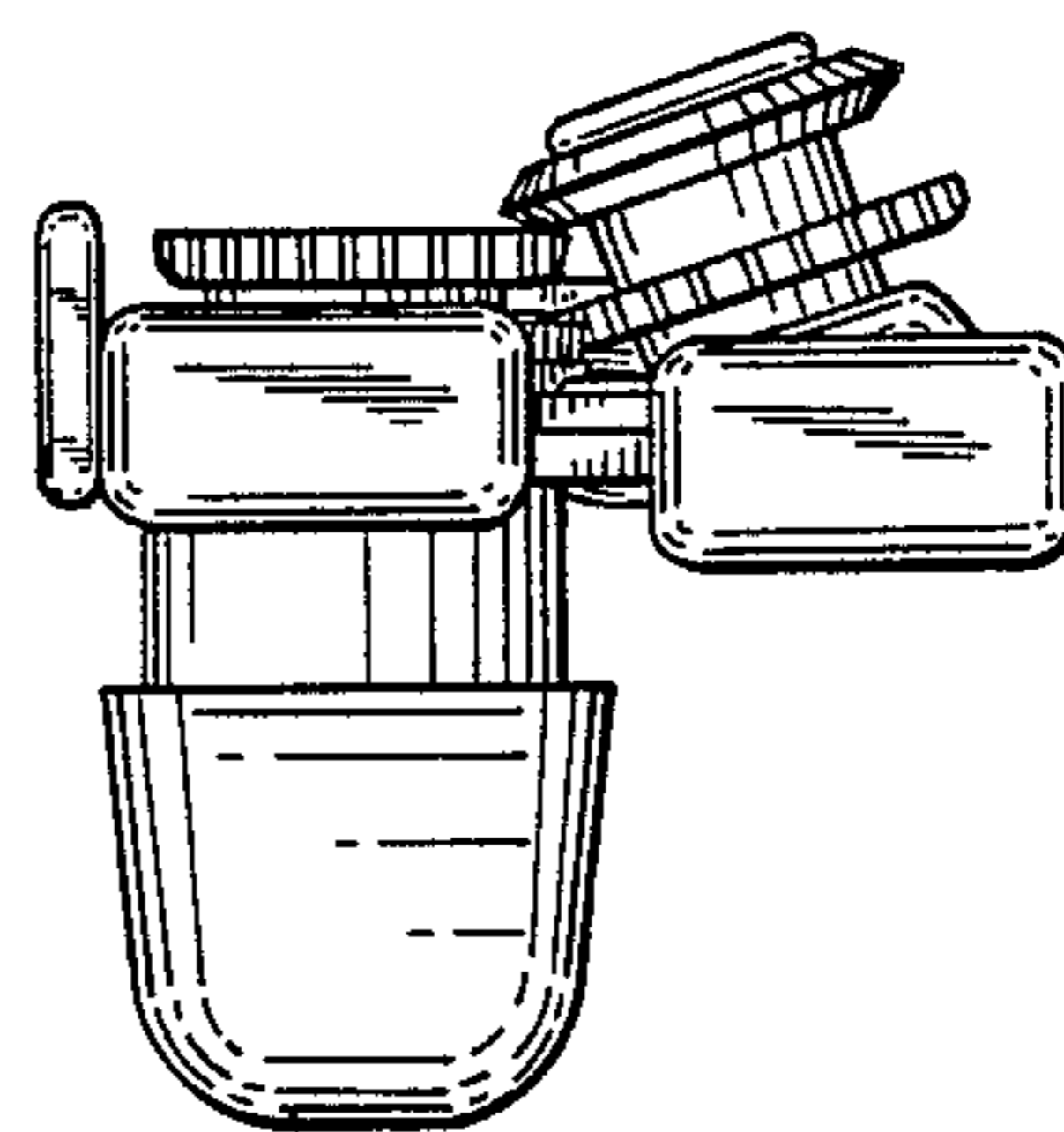

FIG. 2

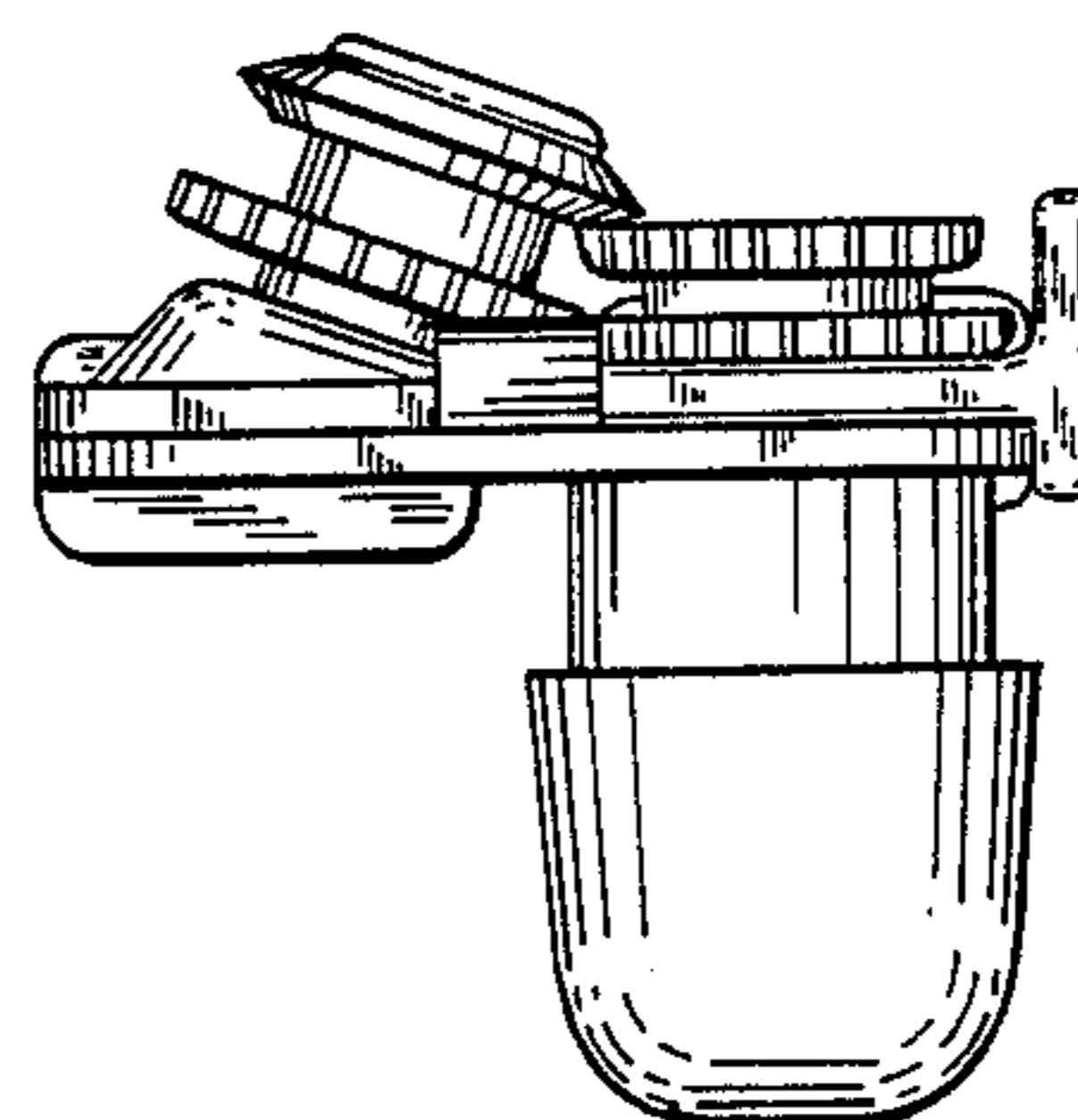

FIG. 3

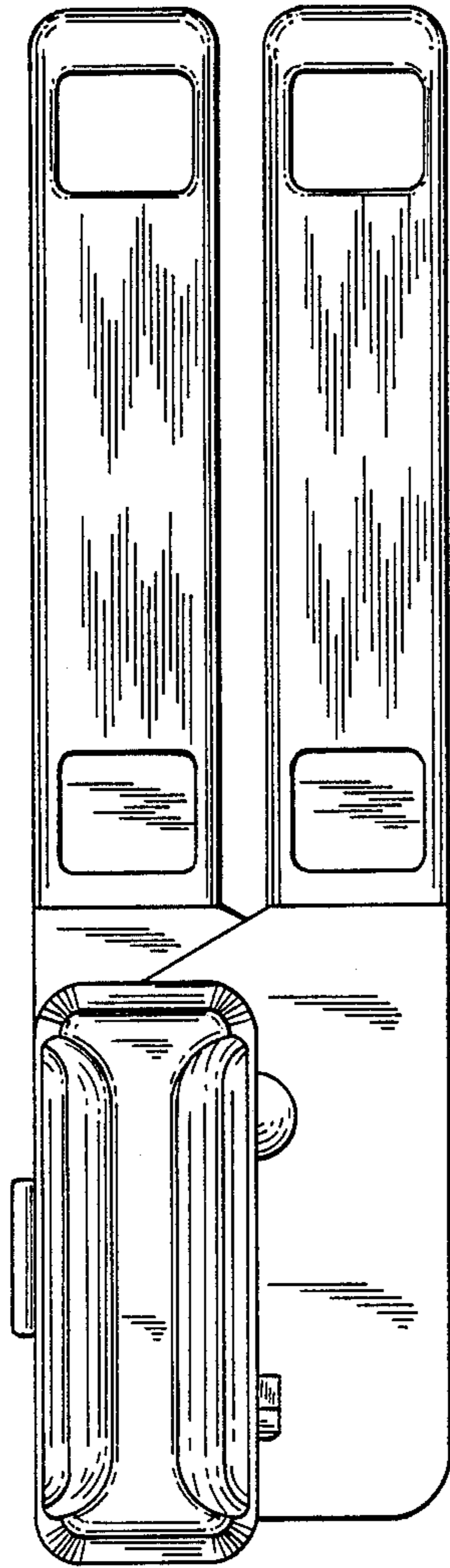

FIG. 4

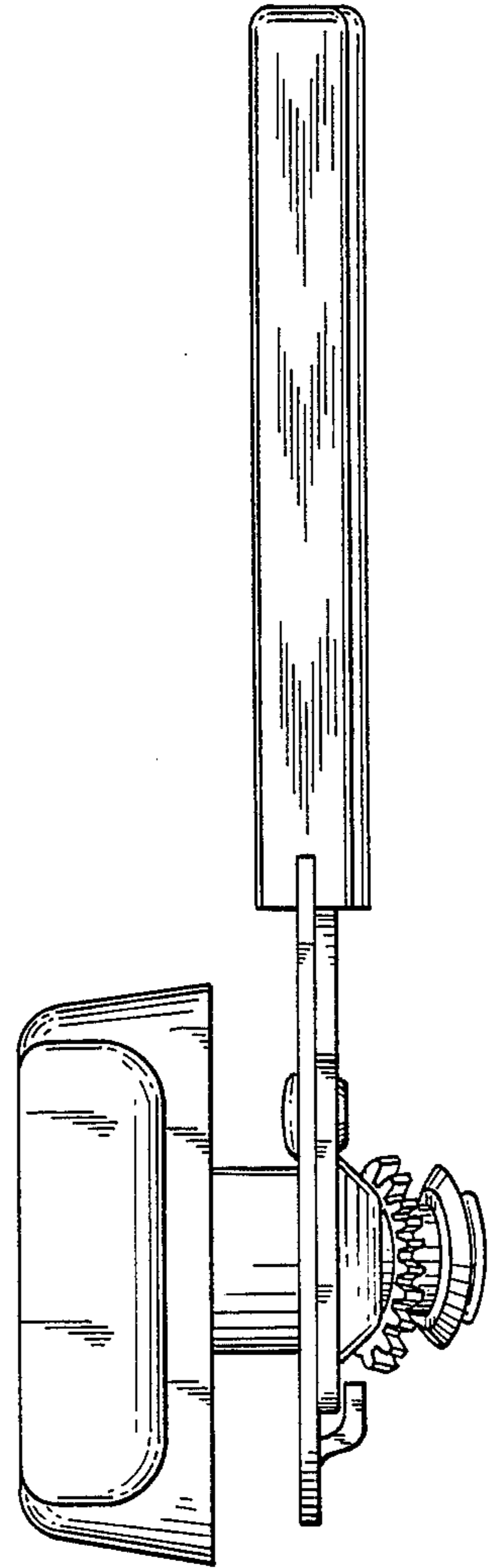

FIG. 5

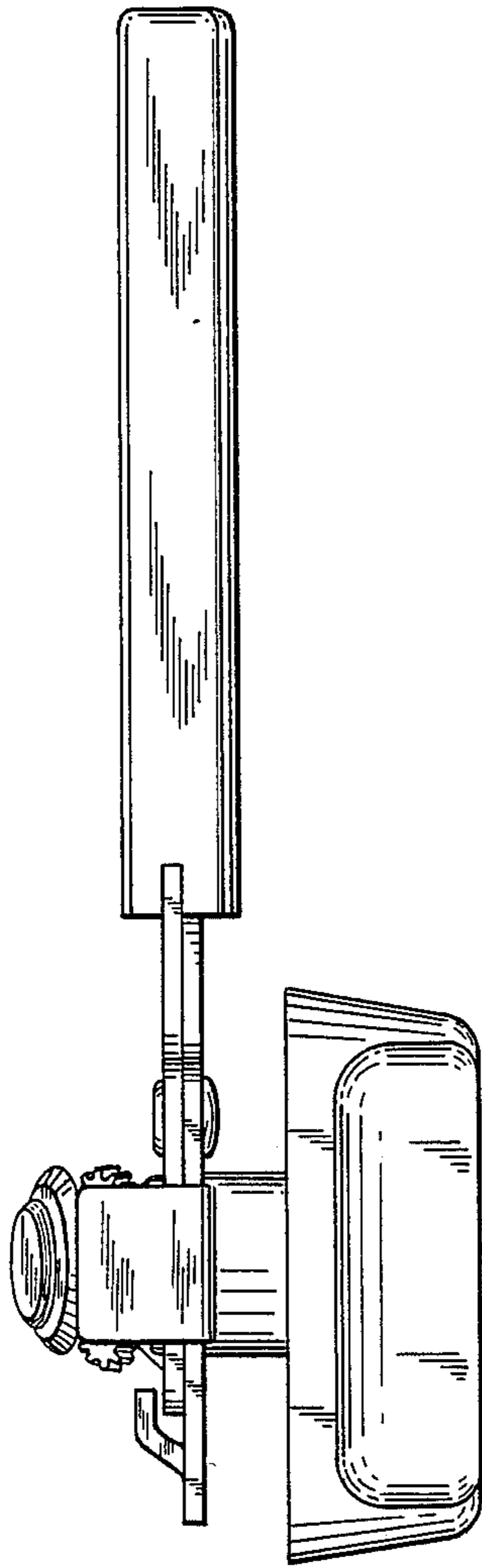

FIG. 6

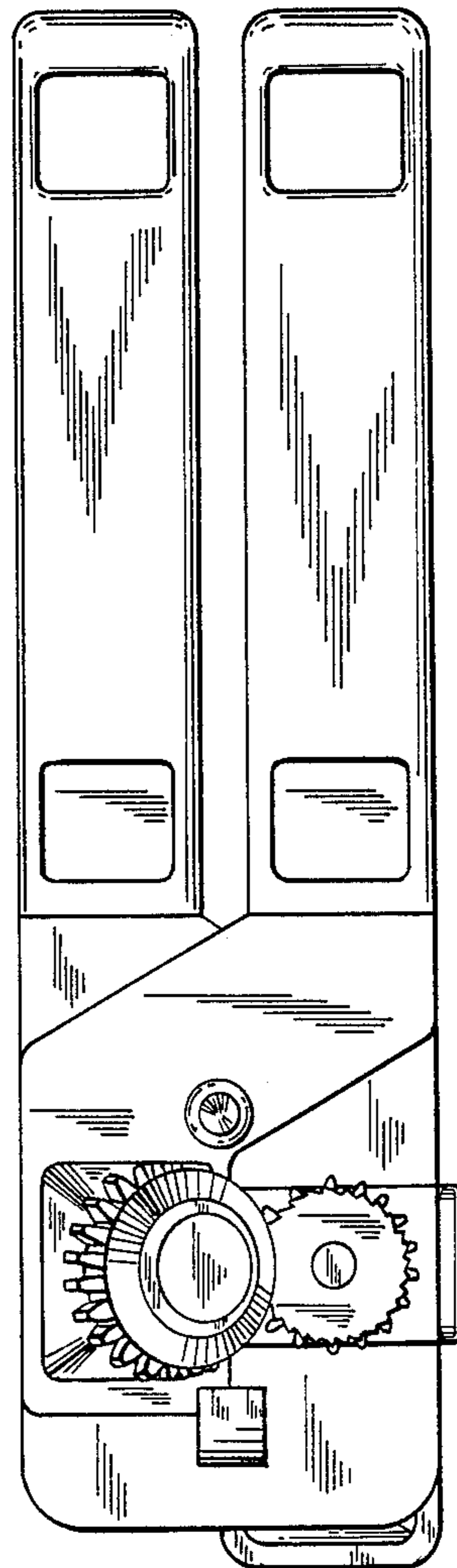

FIG. 7