

[54] TOOTHBRUSH

4,691,404 9/1987 Tarrson et al. 15/167.1

[75] Inventors: Emanuel B. Tarrson; Dane Maric, both of Chicago; Thomas P. Kelly, Palatine, all of Ill.

Primary Examiner—Susan J. Lucas
Attorney, Agent, or Firm—Laff, Whitesel, Conte & Saret

[73] Assignee: John O. Butler Company, Chicago, Ill.

[57] CLAIM

The ornamental design for a toothbrush, as shown and described.

[*] Notice: The portion of the term of this patent subsequent to Aug. 25, 2001 has been disclaimed.

DESCRIPTION

[**] Term: 14 Years

FIG. 1 is a front perspective view of a toothbrush showing my new design, the rear being identical;

[21] Appl. No.: 836,053

FIG. 2 is a side elevational view thereof, the opposite side being identical;

[22] Filed: Mar. 4, 1986

FIG. 3 is a top plan view thereof;

[52] U.S. Cl. D4/104; D4/131

FIG. 4 is a cross-sectional view taken along lines 4—4 of FIG. 2.

[58] Field of Search D4/100-114, D4/127, 128, 129, 134, 135, 136, 131; D24/10; 15/106, 107, 111, 143 R, 167.1, 167.3

FIG. 5 is a bottom plan view thereof;

[56] References Cited

FIG. 6 is a front elevational view of a second embodiment of my new design, the second embodiment differing from the first only in the configuration of the bristles;

U.S. PATENT DOCUMENTS

- D. 176,748 1/1956 Asturias, Jr. D4/108
- D. 291,504 8/1987 Tarrson et al. D4/104
- D. 291,505 8/1987 Tarrson et al. D4/104

FIG. 7 is a front elevational view of a third embodiment of my new design, the third embodiment differing from the first embodiment only in the configuration of the bristles.

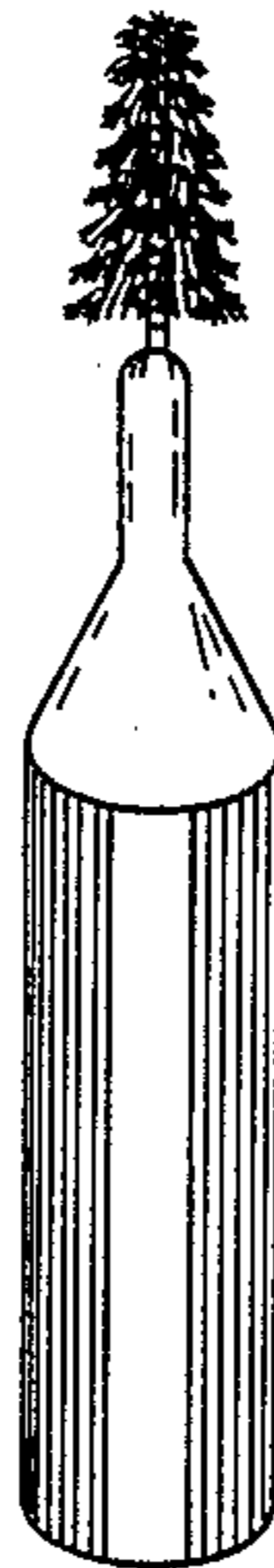

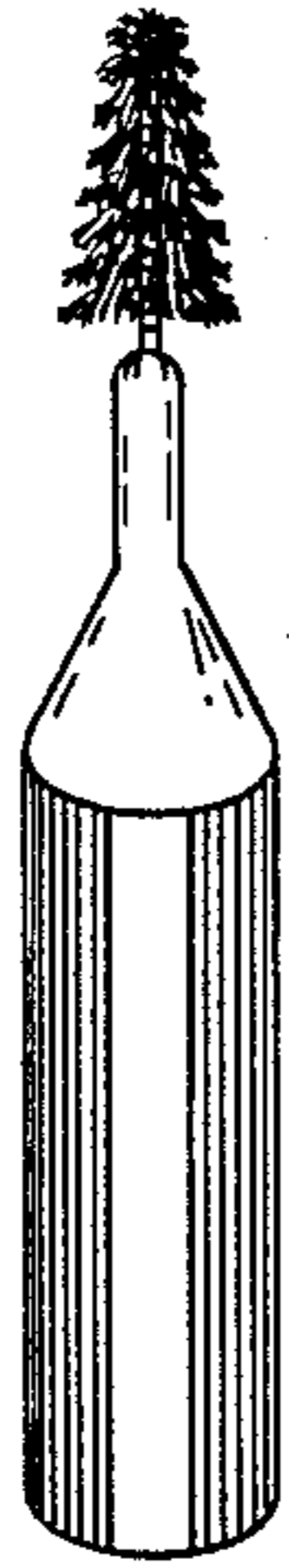

FIG. 1

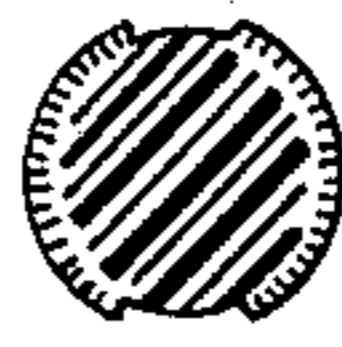

FIG. 4



FIG. 3

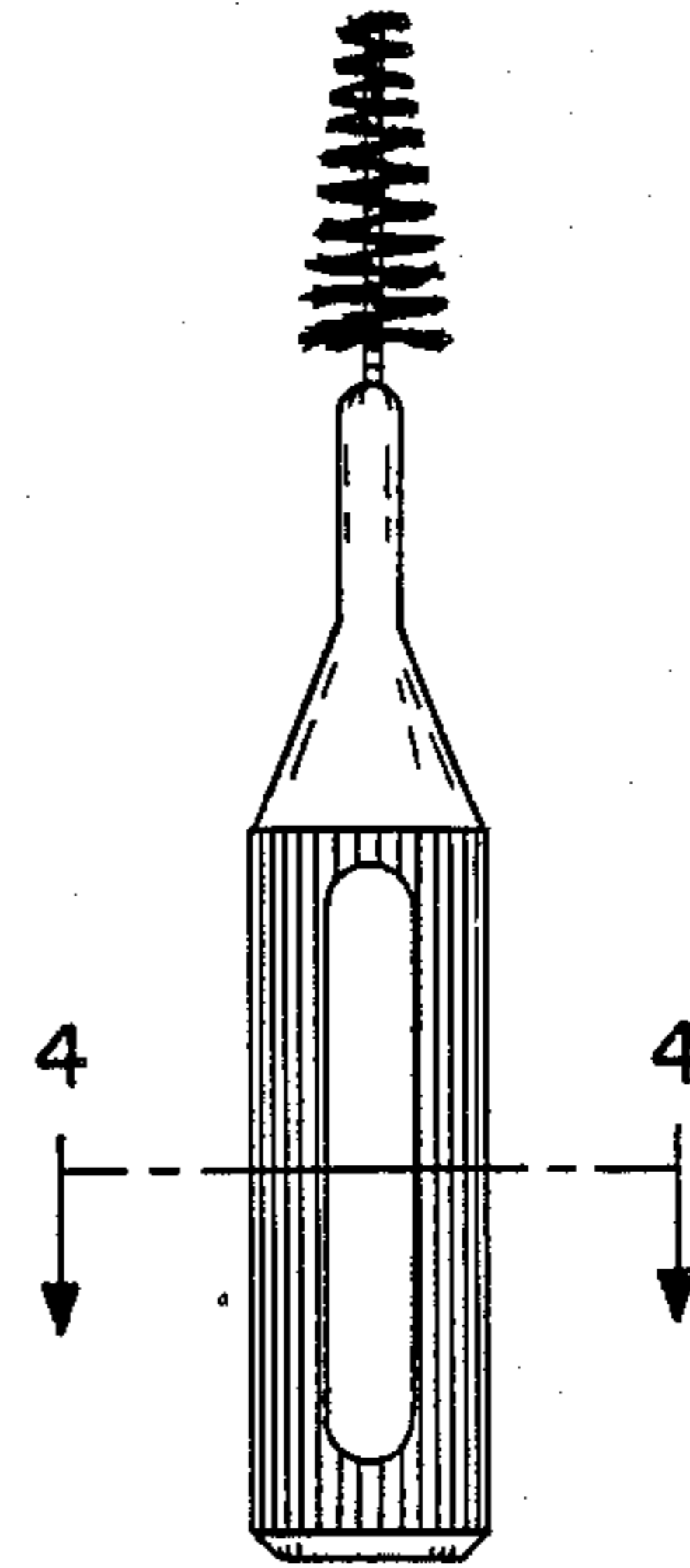

FIG. 2

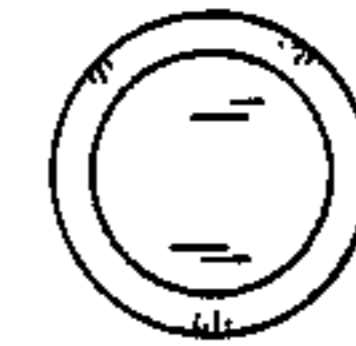

FIG. 5

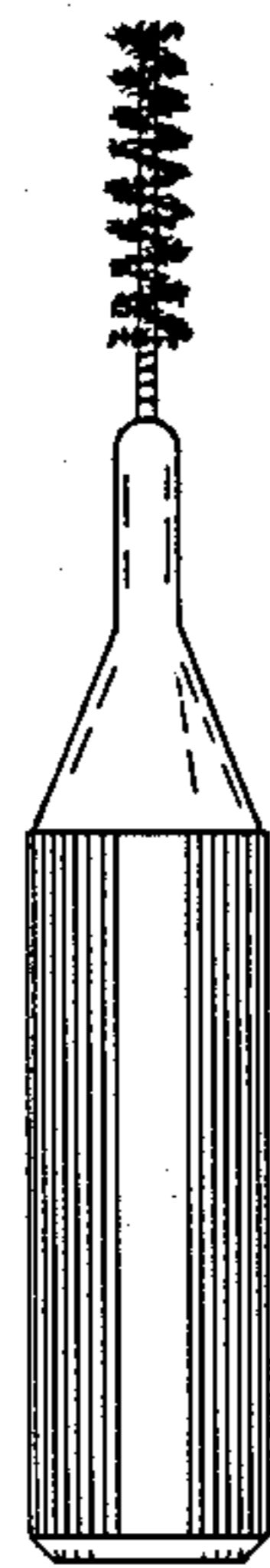

FIG. 6

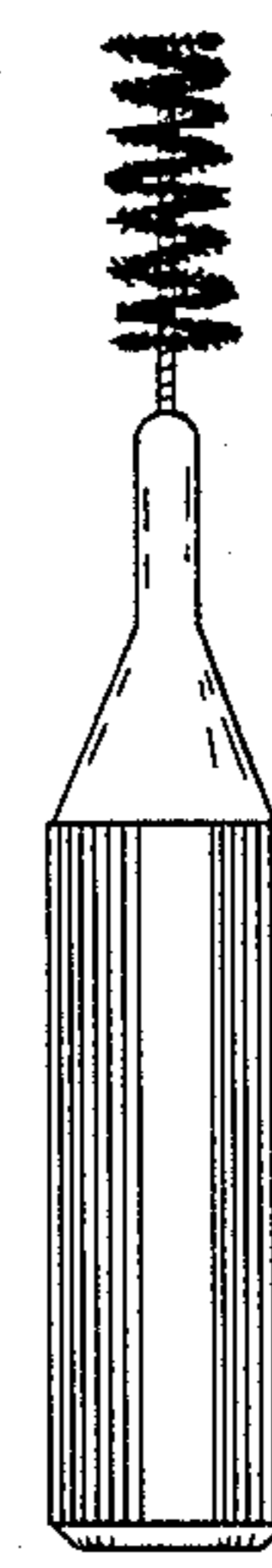

FIG. 7