

[54] LABEL BOX DISPLAY CASE

[75] Inventor: Daniel C. Helsel, R.D. 3, Box 144, Hollsopple, Pa. 15935

[73] Assignee: Daniel C. Helsel, Hollsopple, Pa.

[**] Term: 14 Years

[21] Appl. No.: 916,850

[22] Filed: Oct. 8, 1986

[52] U.S. Cl. D6/476

[58] Field of Search D6/449, 459, 460, 461, D6/466, 476; 211/13

[56] References Cited

U.S. PATENT DOCUMENTS

- D. 129,718 9/1941 West D6/470
- D. 142,027 8/1945 Glass D6/449
- D. 163,847 5/1951 Brocken D6/476

- D. 243,730 3/1977 Koenig et al. D6/449
- D. 279,523 7/1985 Seltzer et al. D6/449 X
- D. 285,993 10/1986 Genna D6/476 X

Primary Examiner—Carmen H. Vales-Lado
Attorney, Agent, or Firm—Fidelman & Wolffe

[57] CLAIM

The ornamental design for a label box display case, as shown and described.

DESCRIPTION

FIG. 1 is a front perspective view of a label box display case showing my new design;
 FIG. 2 is a rear perspective view thereof;
 FIG. 3 is a front elevational view thereof;
 FIG. 4 is a rear elevational view thereof;
 FIG. 5 is a right side elevational view thereof; and
 FIG. 6 is a left side elevational view taken along lines 6—6 of FIG. 3.

The bottom is flat and unornamented.

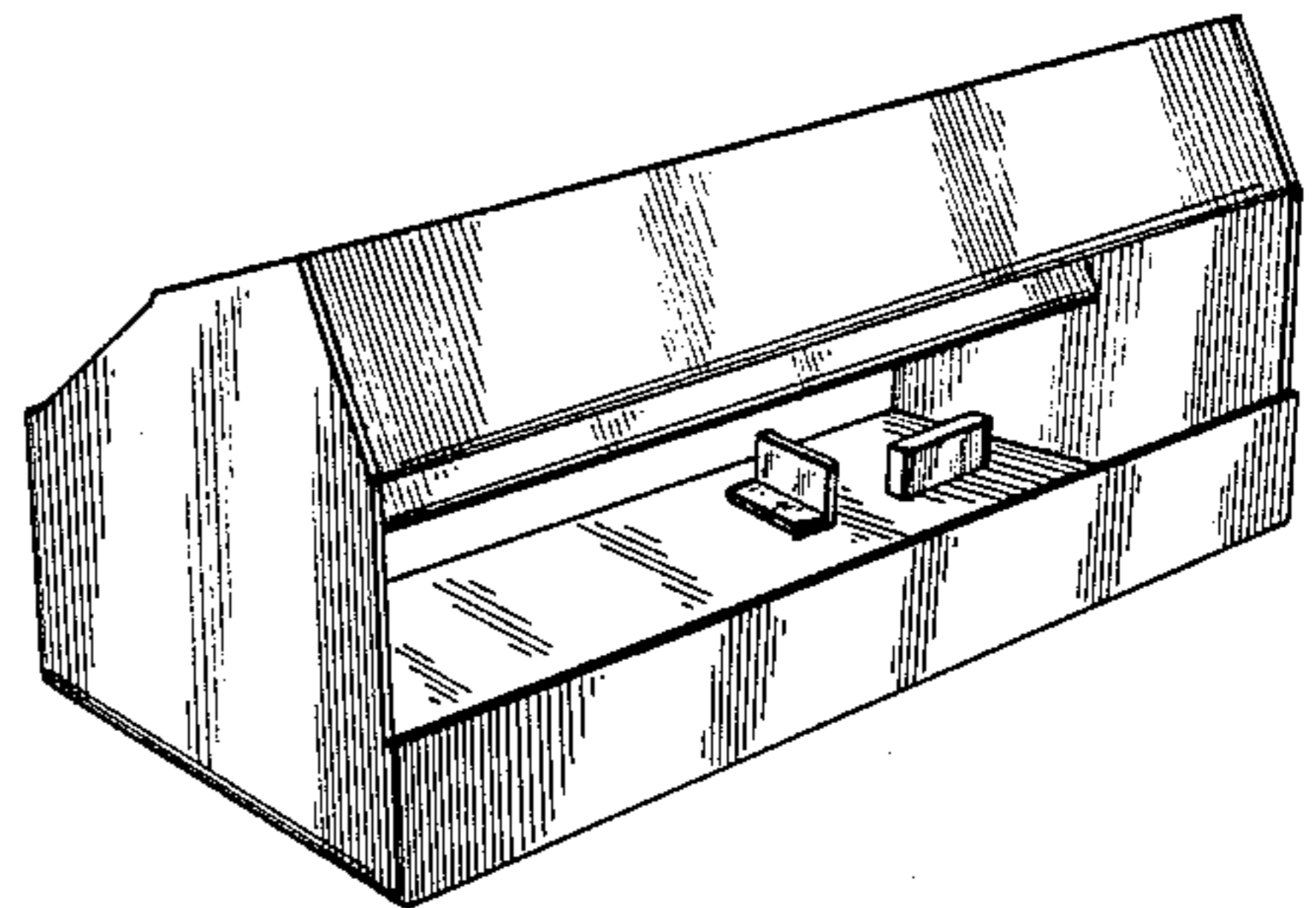
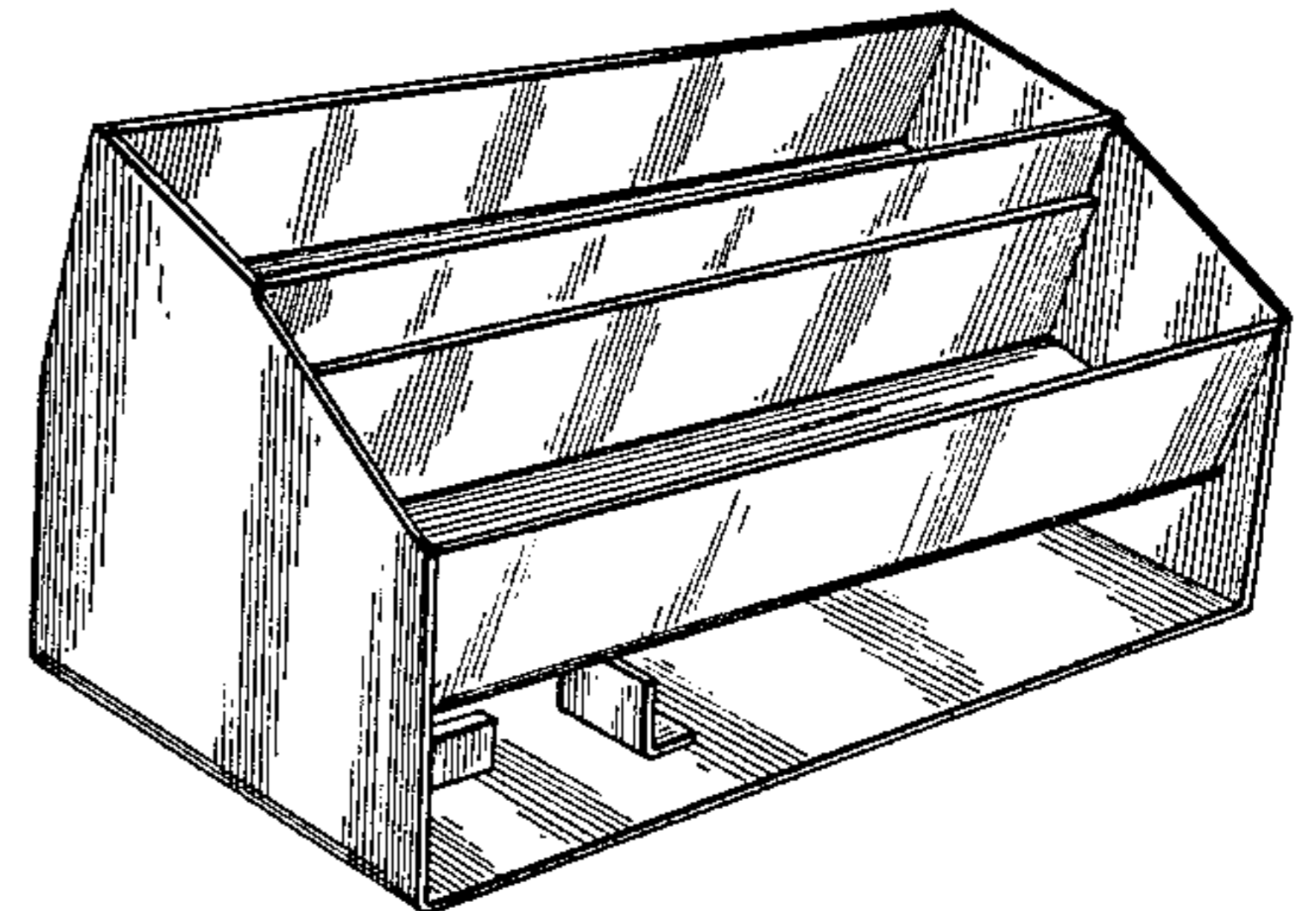
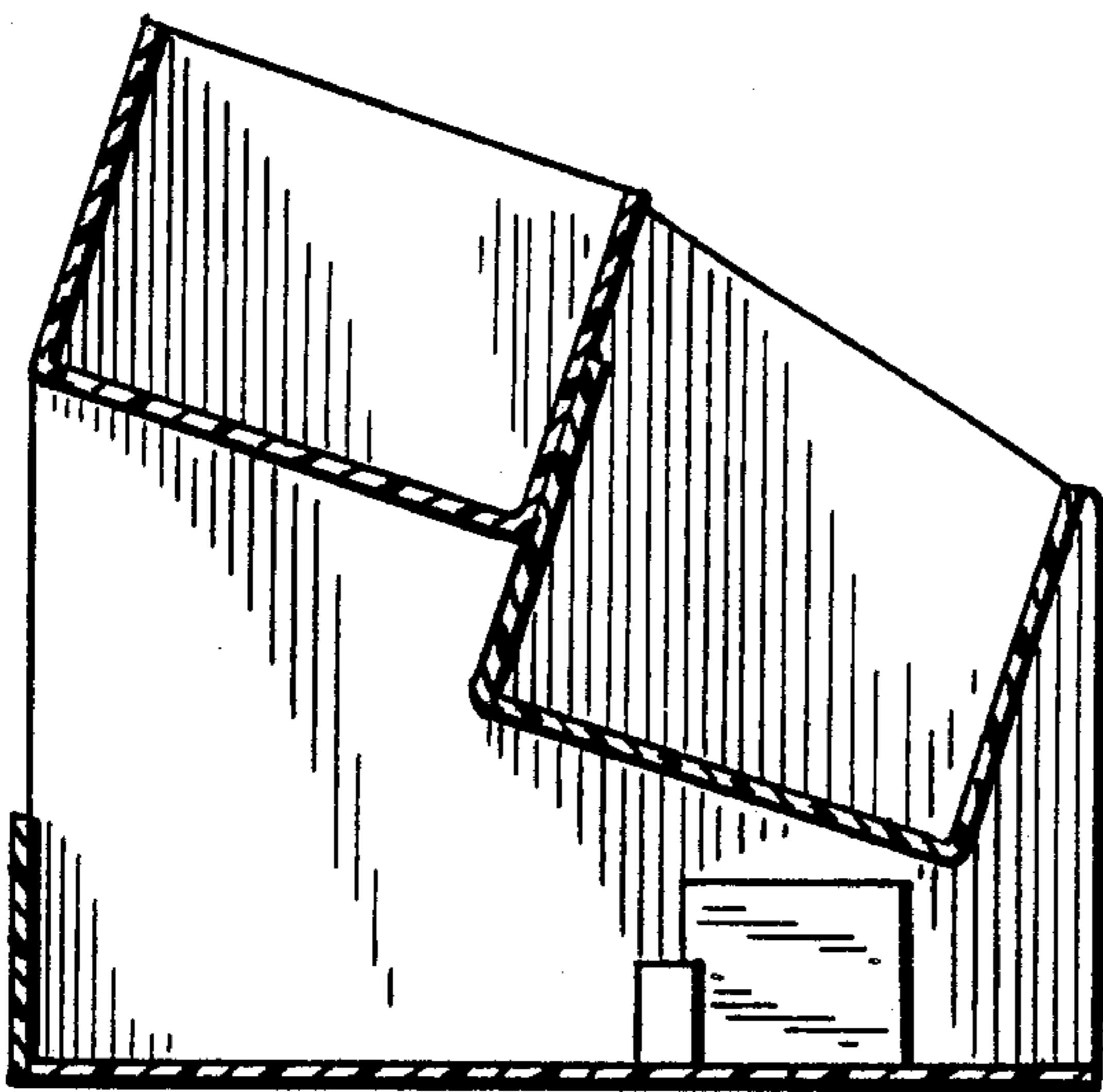

Fig. 1

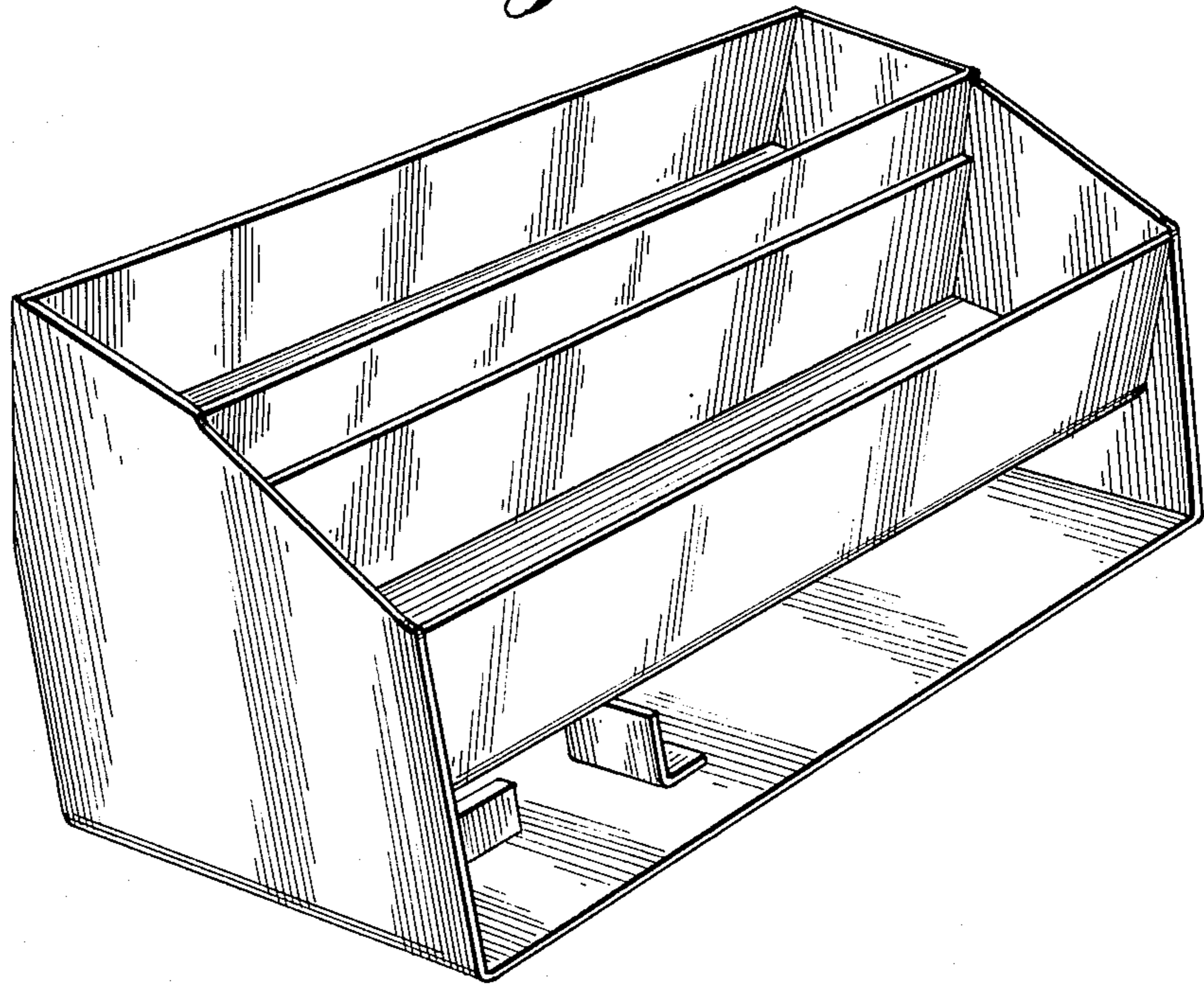

Fig. 2

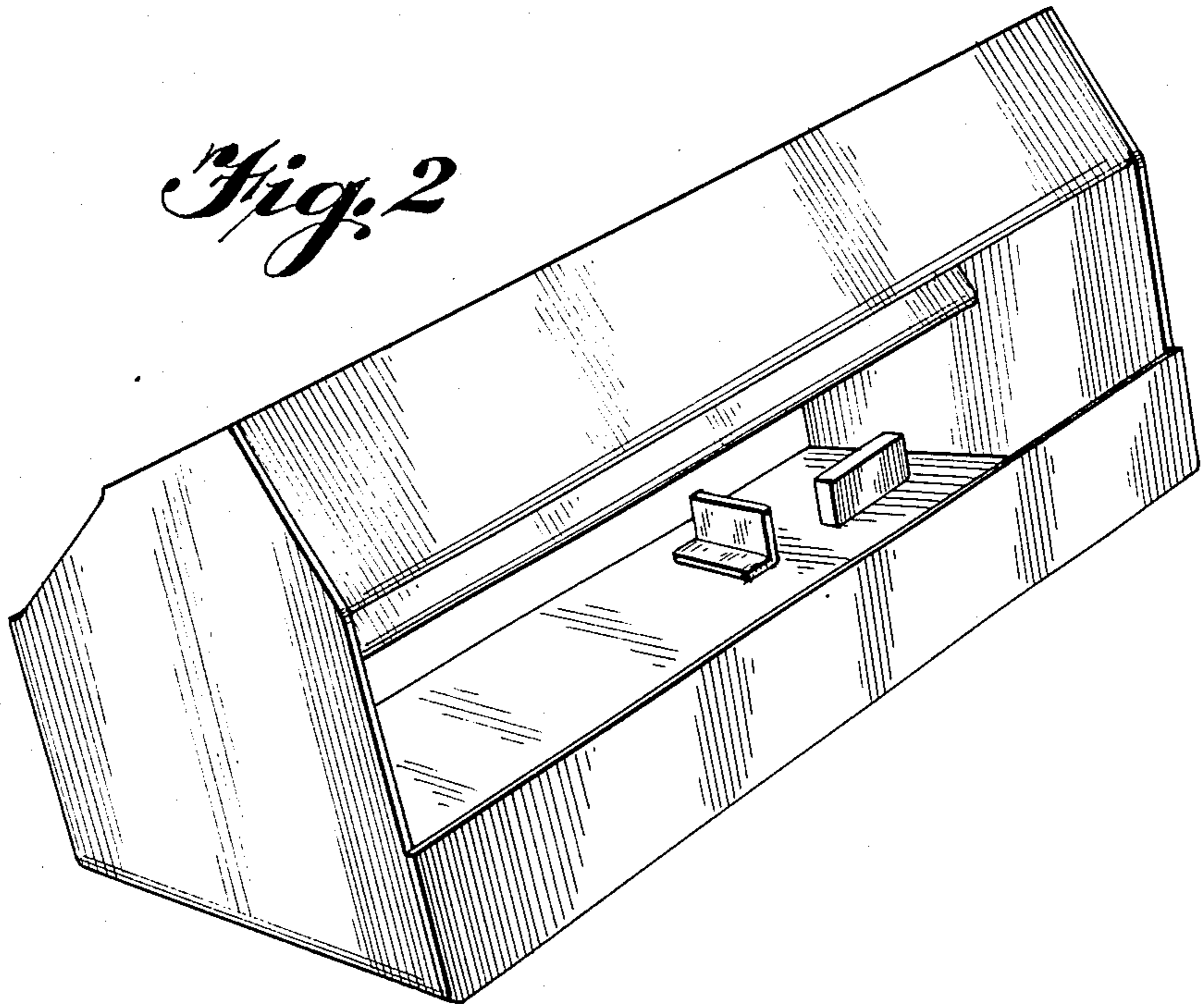

Fig. 3

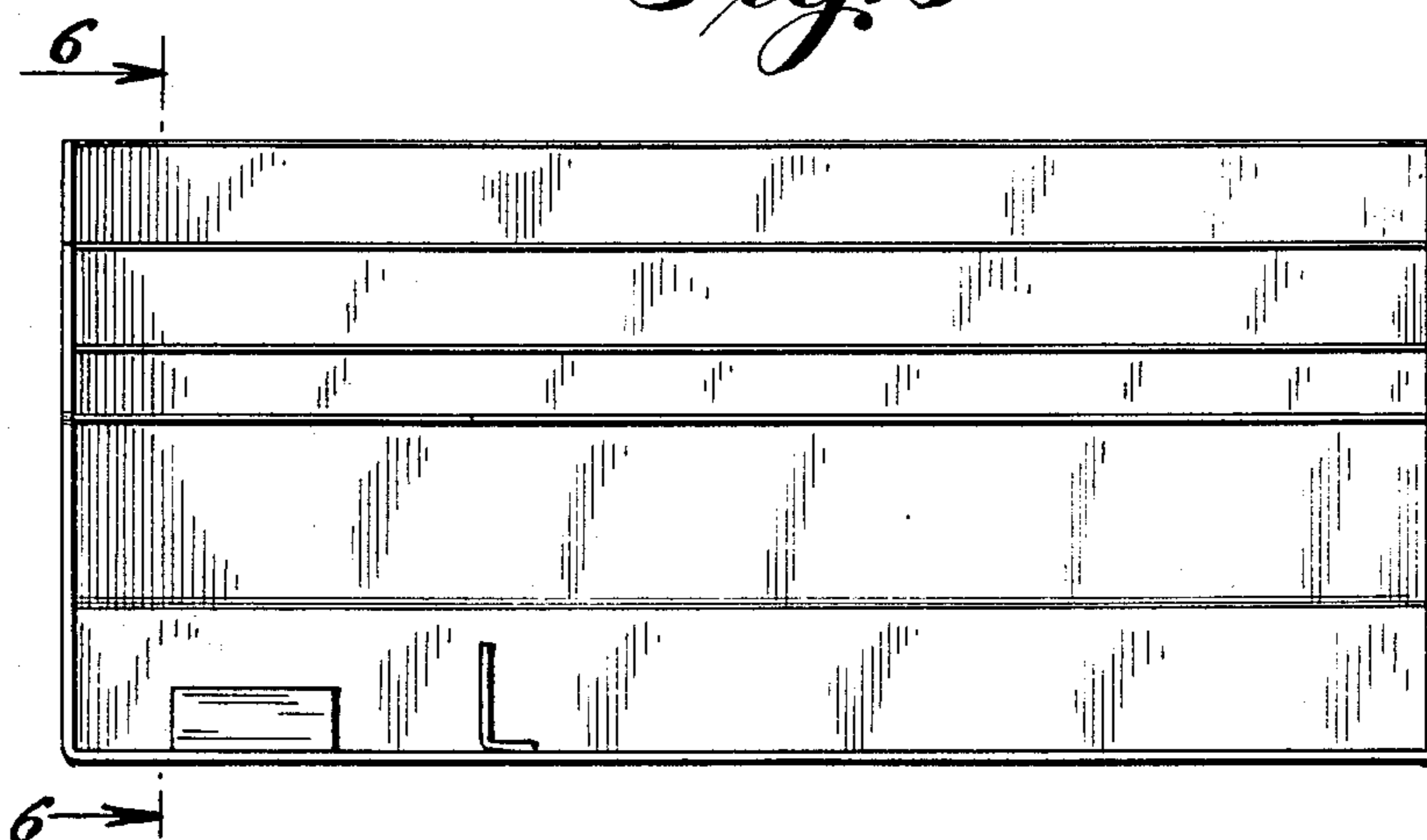

Fig. 4

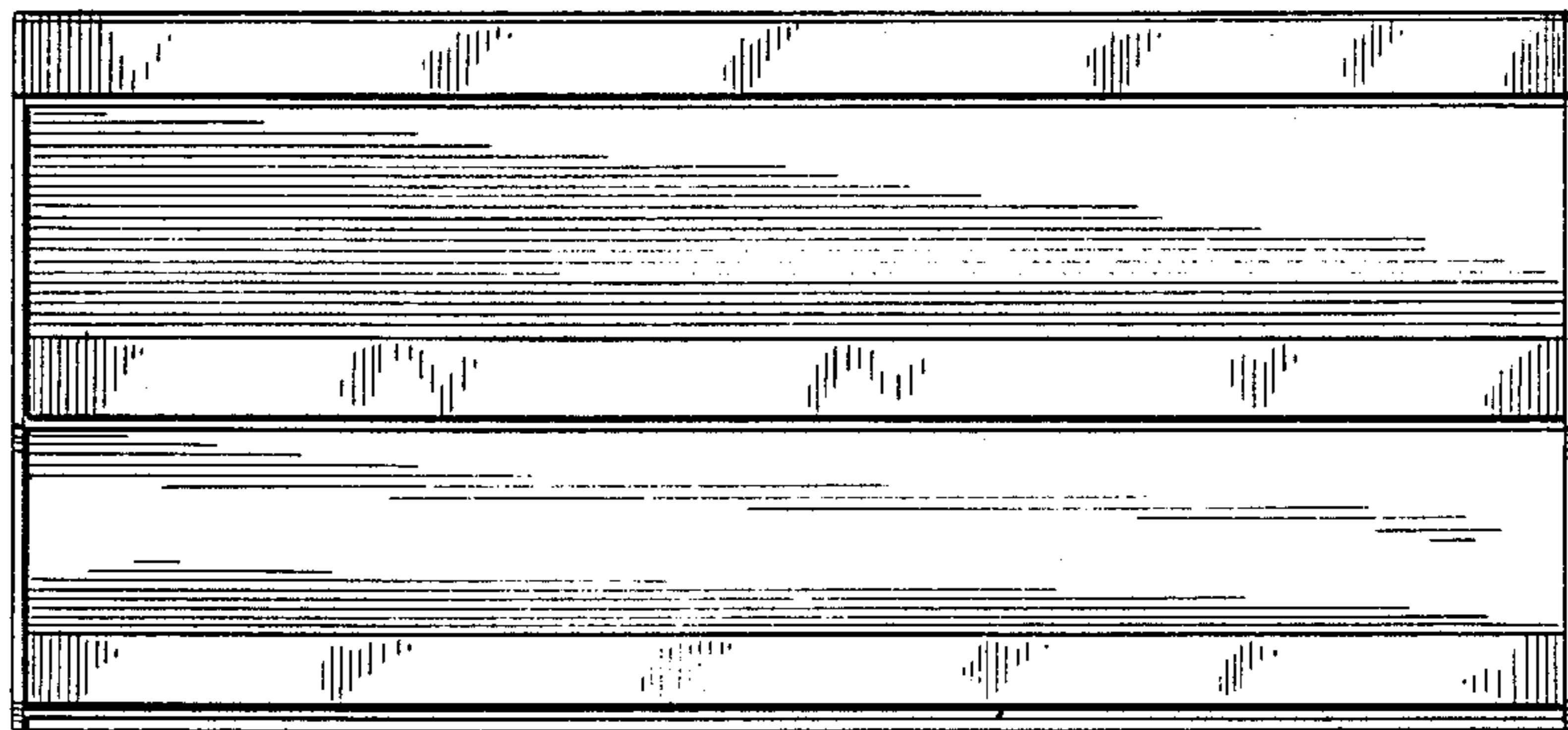

Fig. 5

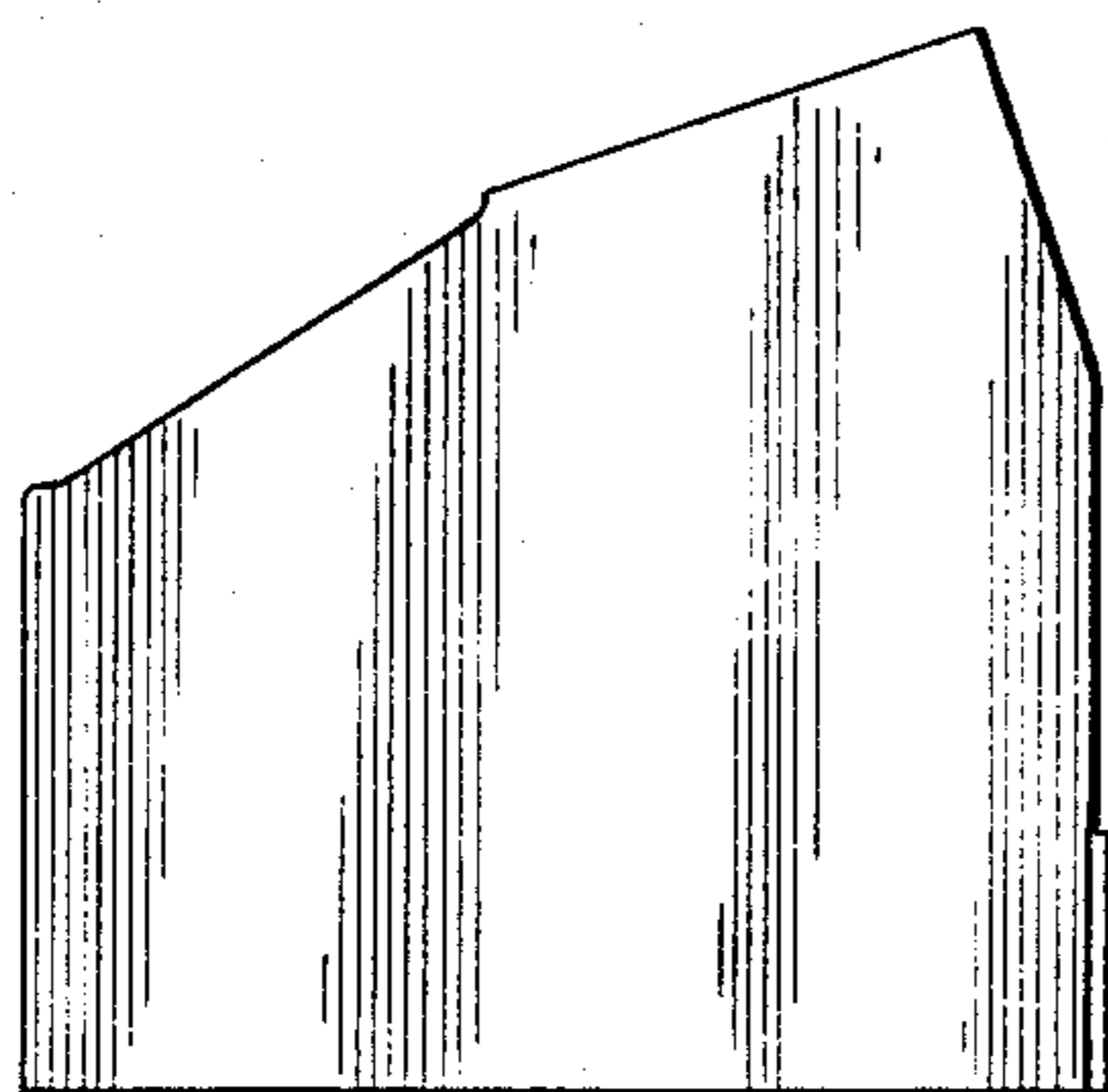

Fig. 6

