

[54] SHIPPING CENTER KIOSK
 [75] Inventor: William F. Wolff, Jr., Clearwater, Fla.
 [73] Assignee: Automated Shipping Machines, Inc., Sarasota, Fla.
 [**] Term: 14 Years
 [21] Appl. No.: 905,030
 [22] Filed: Sep. 5, 1986
 [52] U.S. Cl. D10/91
 [58] Field of Search D14/100-117; D10/90, 91, 93; D18/36, 38, 39; D16/223, 246, 247, 27; 340/700; 177/2, 3, 4, 5, 25, 26, 238, 239, 243, 25.15; 361/334, 346, 379, 380, 381, 383, 384, 390; 174/16 R; 346/22; 358/93; 220/4 R; 362/812

3,741,324 6/1973 Boshinski et al. 177/3
 3,897,901 8/1975 Grosswiller, Jr. et al. 346/22 X
 4,179,723 12/1979 Spencer 361/384
 4,274,500 6/1981 Kuhnle 177/239 X
 4,462,473 7/1984 Valestin 177/25.15
 4,601,355 7/1986 Takahashi 177/2

Primary Examiner—Susan J. Lucas
 Assistant Examiner—Freda S. Nunn
 Attorney, Agent, or Firm—Pettis & McDonald

[57] CLAIM

The ornamental design for a shipping center kiosk, as shown.

DESCRIPTION

FIG. 1 is front elevational view of the shipping center kiosk showing my new design;
 FIG. 2 is a top plan view thereof;
 FIG. 3 is a bottom plan view thereof;
 FIG. 4 is a rear elevational view thereof;
 FIG. 5 is left side elevational view thereof;
 FIG. 6 is a right side elevational view thereof; and
 FIG. 7 is front perspective view thereof.

[56] References Cited
 U.S. PATENT DOCUMENTS
 D. 254,427 3/1980 Perrier D10/91
 2,912,066 11/1959 Ellithorpe 358/93 X

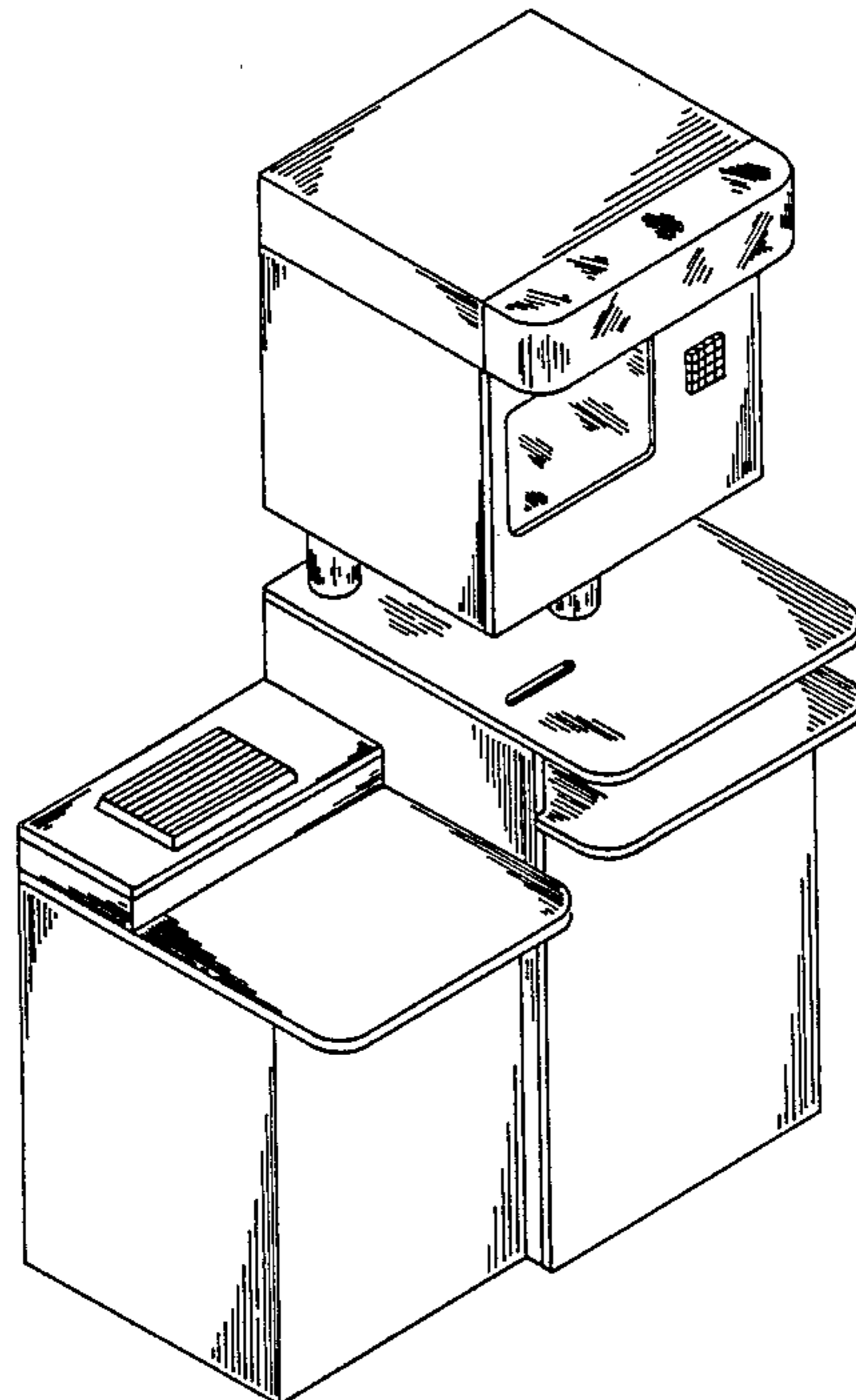

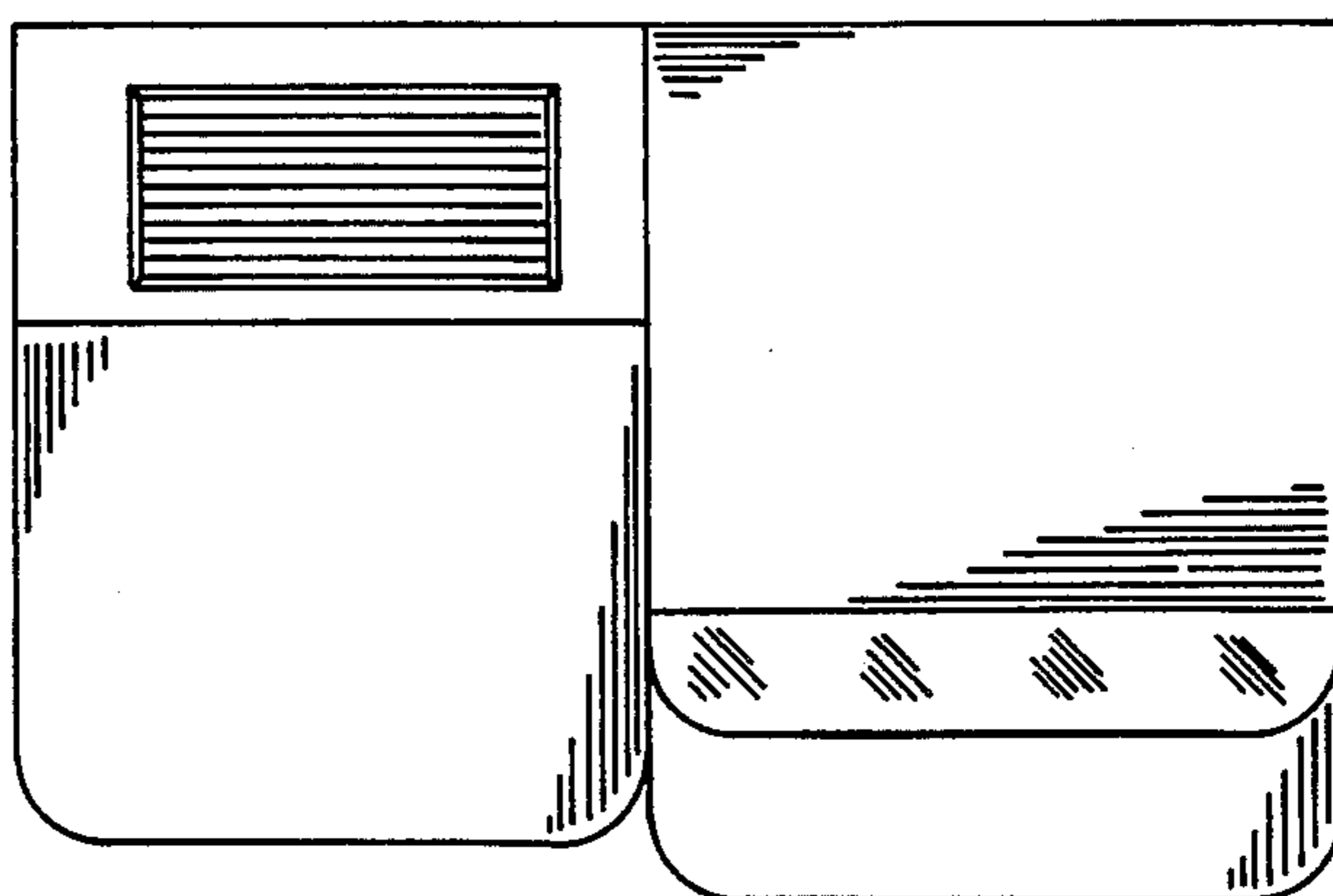

FIG. 2

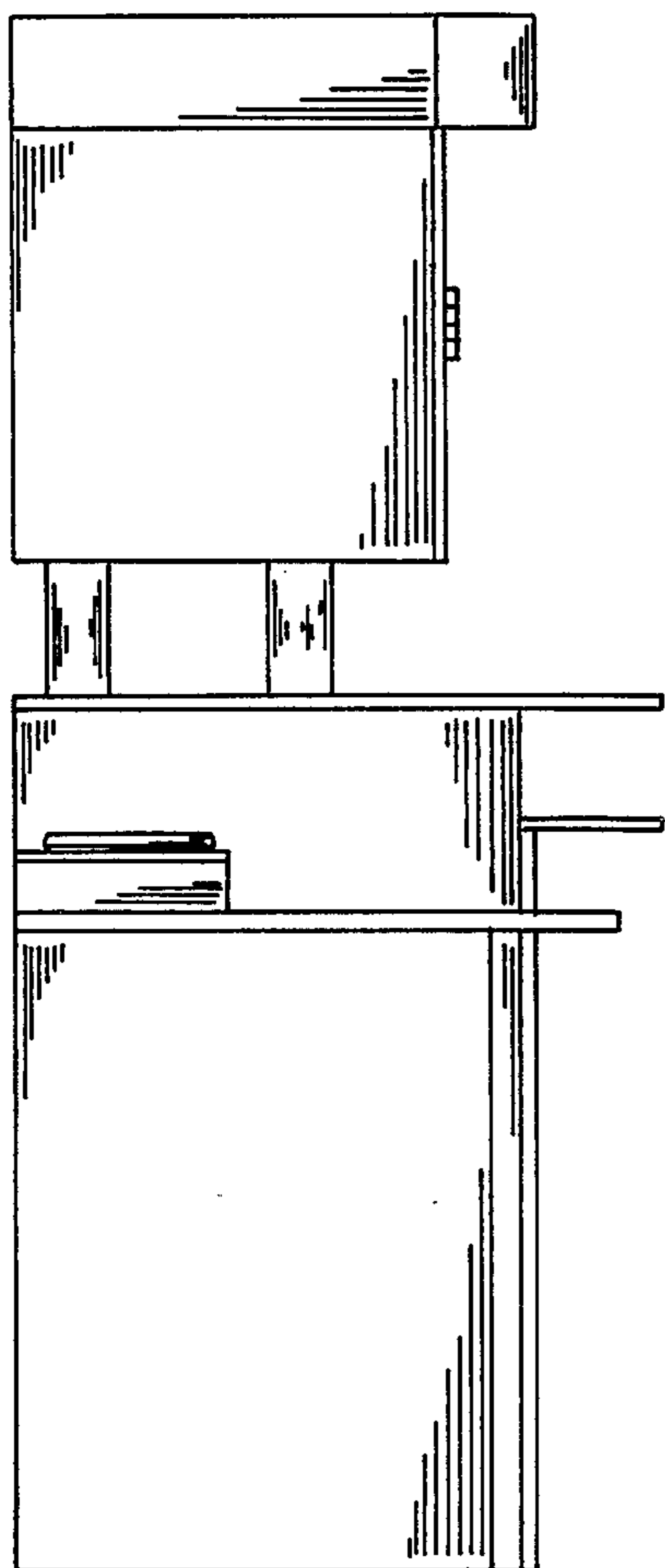

FIG. 6

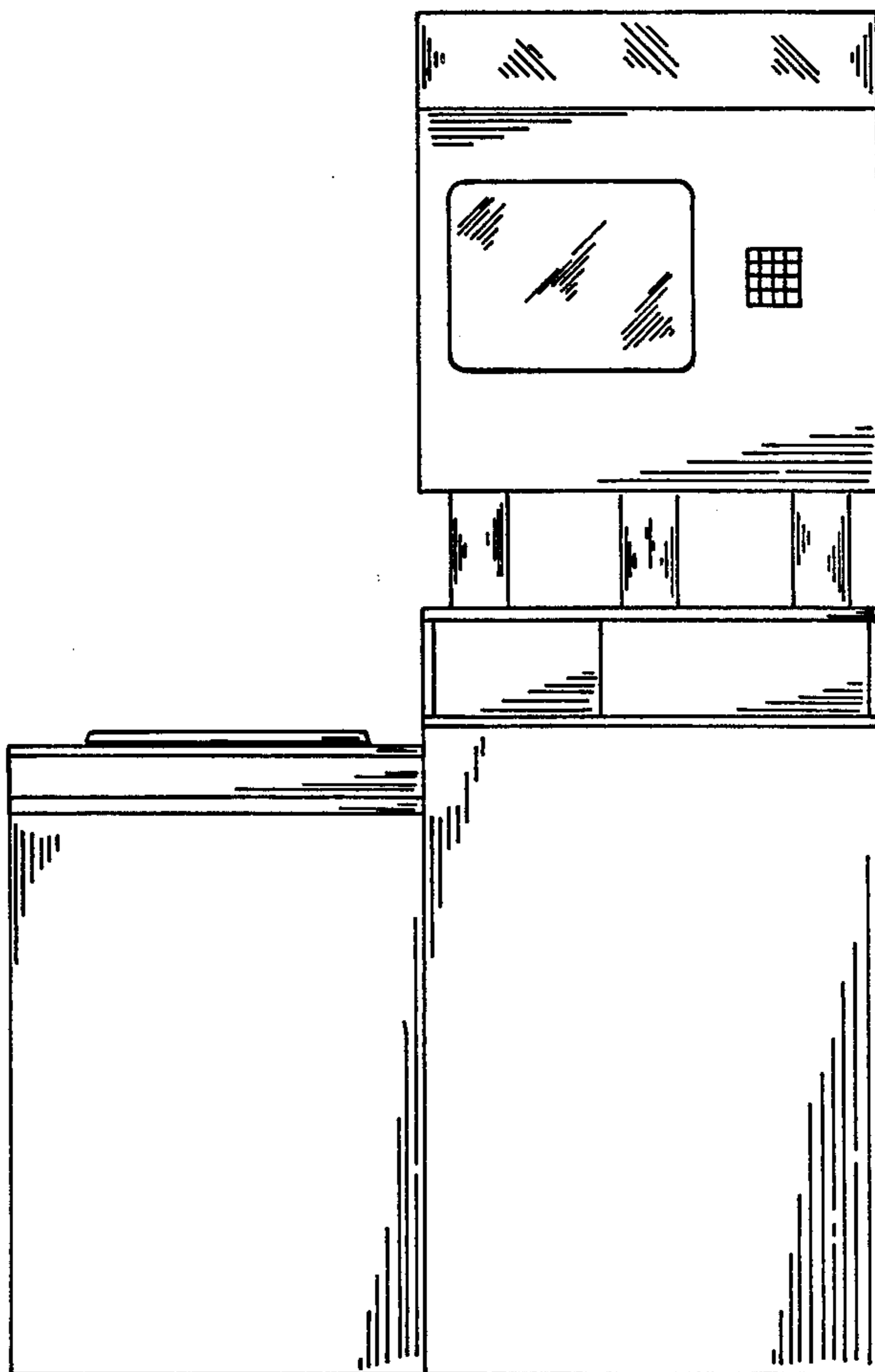

FIG. 1

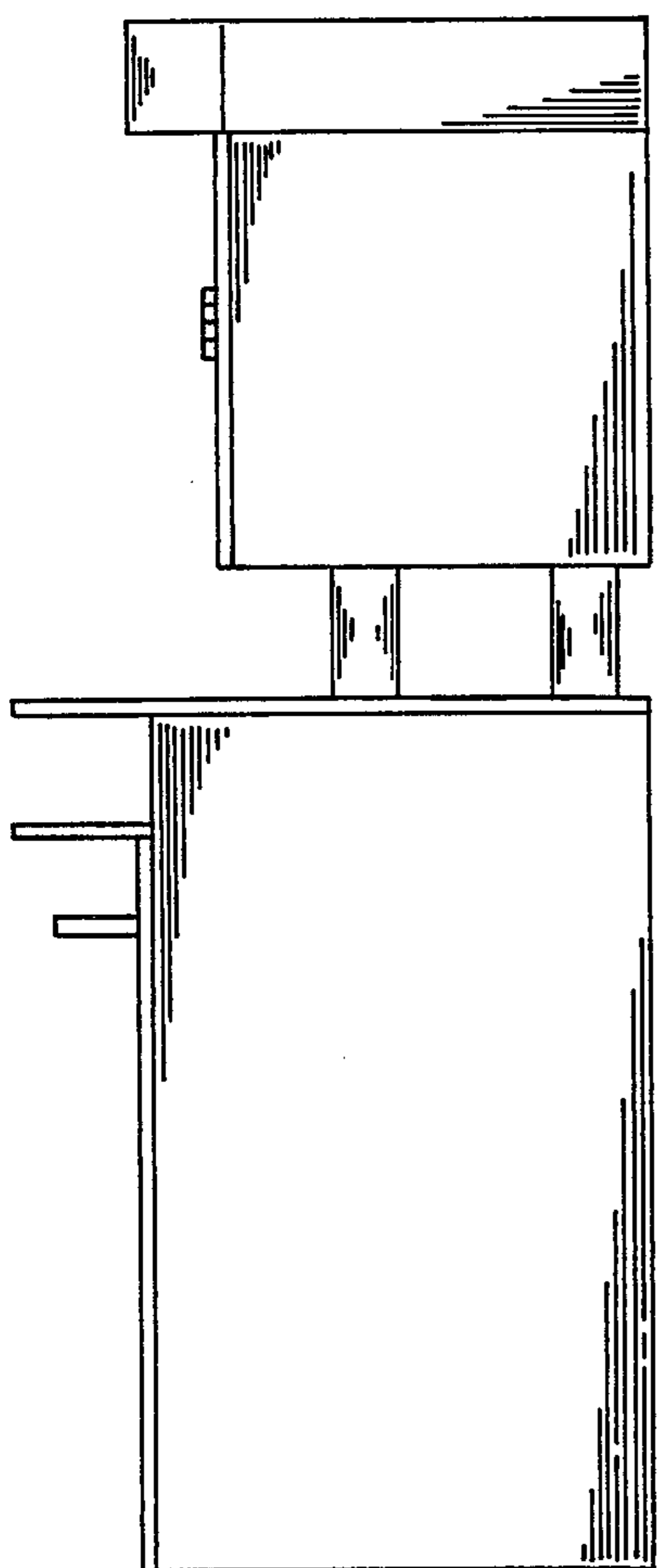

FIG. 5

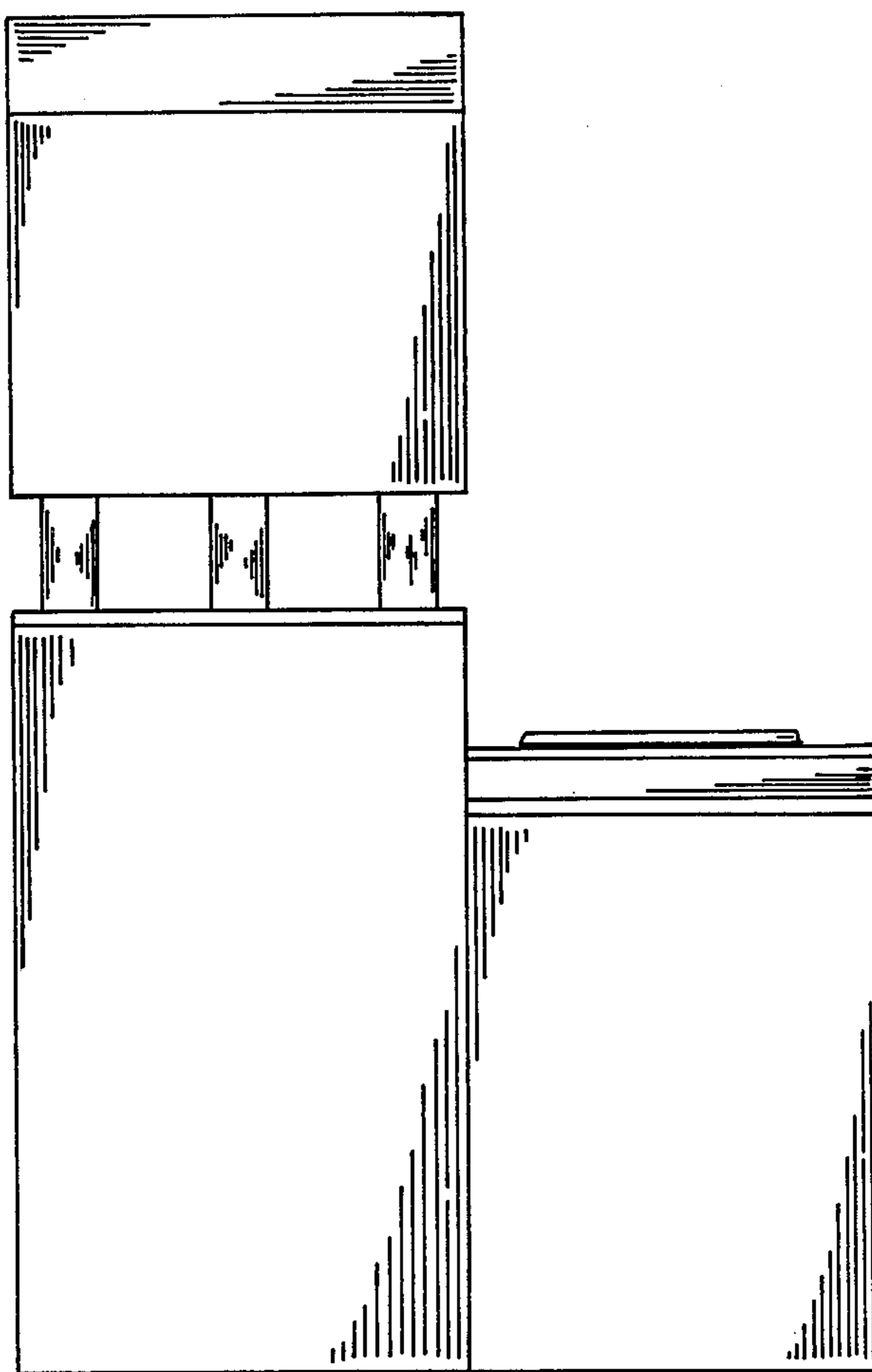

FIG. 4

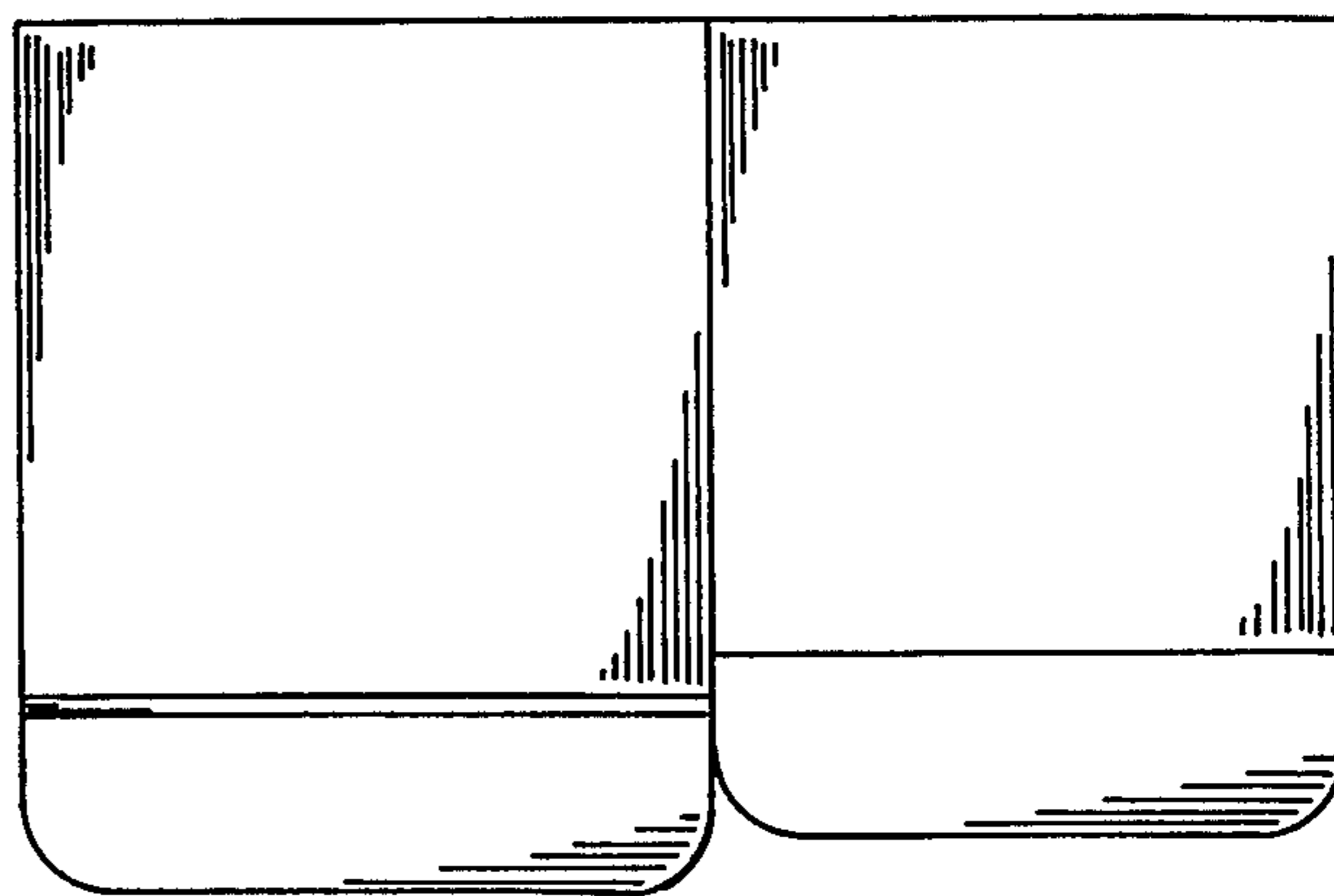

FIG. 3

