

[54] **ADJUSTABLE TABLE LAMP**

[75] **Inventor: Michele De Lucchi, Milan, Italy**  
[73] **Assignee: Artemide S.P.A., Milan, Italy**  
[\*] **Notice: The portion of the term of this patent subsequent to Aug. 8, 2003 has been disclaimed.**  
[\*\*] **Term: 14 Years**  
[21] **Appl. No.: 5,525**  
[22] **Filed: Jan. 20, 1987**

[30] **Foreign Application Priority Data**  
Jul. 23, 1986 [IT] Italy ..... 22611 B/86  
[52] **U.S. Cl. .... D26/65**  
[58] **Field of Search ..... 362/410-414, 362/401, 402, 418, 419, 427, 428, 269, 275, 285, 371; D26/60-66**

[56] **References Cited**  
**U.S. PATENT DOCUMENTS**  
D. 264,634 5/1982 Okuno ..... D26/65  
3,188,460 6/1965 Thorsen et al. .... 362/418 X  
3,994,464 11/1976 Perbal ..... 362/419 X

**FOREIGN PATENT DOCUMENTS**

117122 7/1946 Sweden ..... 362/427

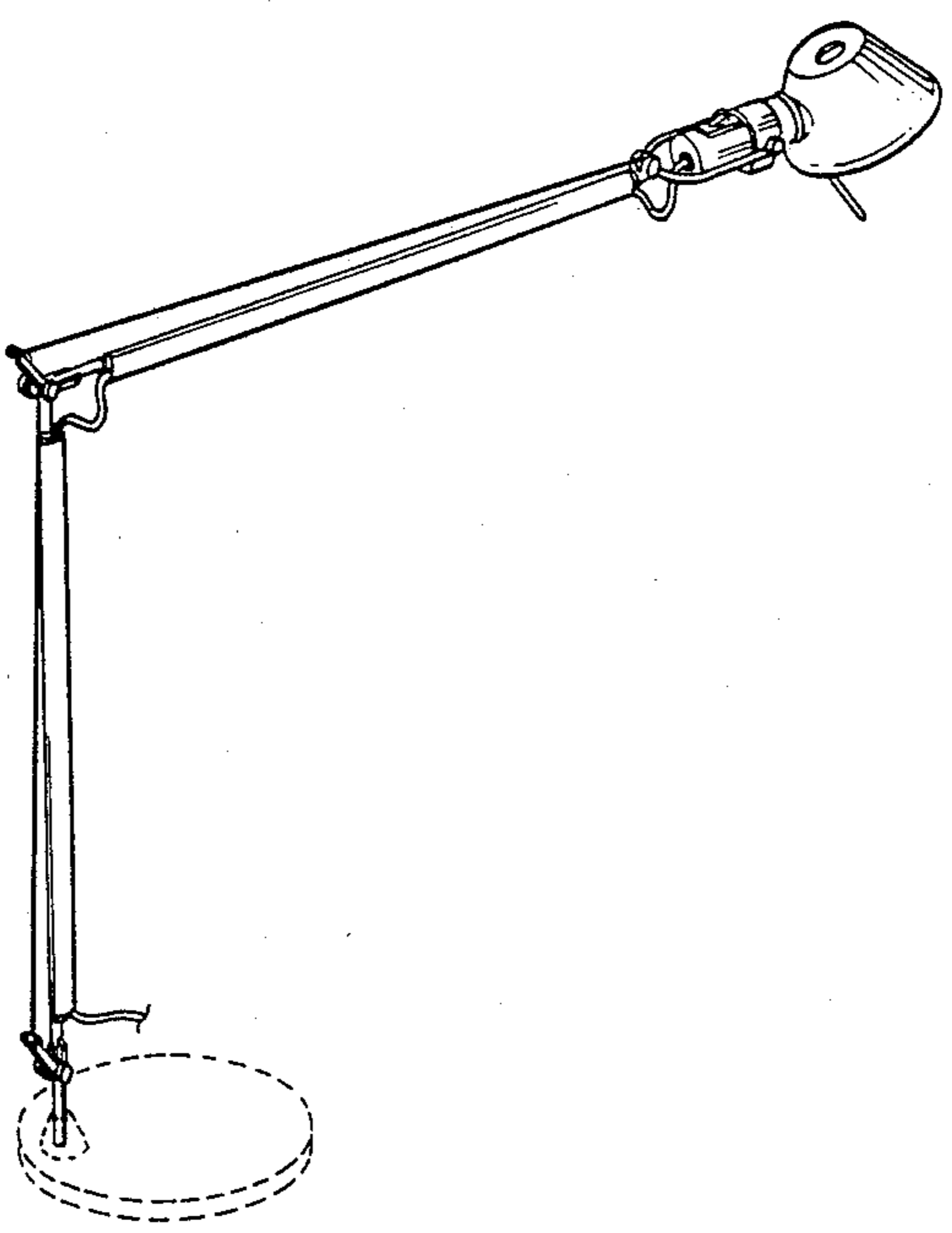
*Primary Examiner*—Susan J. Lucas  
*Attorney, Agent, or Firm*—Guido Modiano; Albert Josif

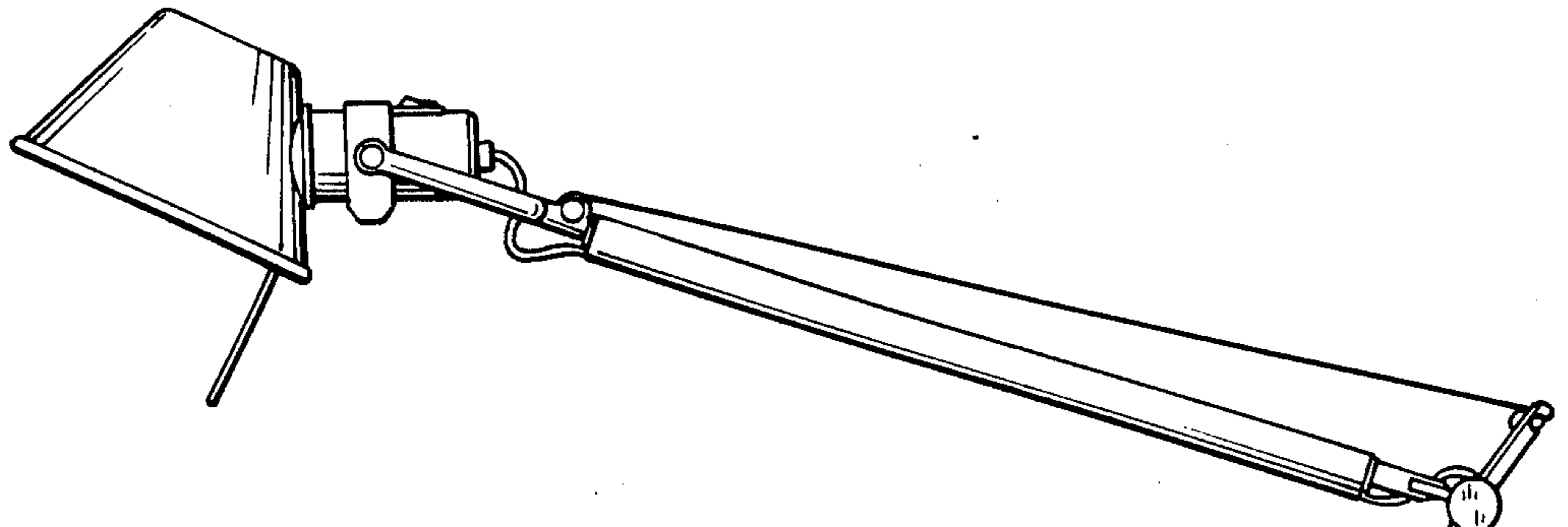
[57] **CLAIM**

The ornamental design for adjustable table lamp, as shown and described.

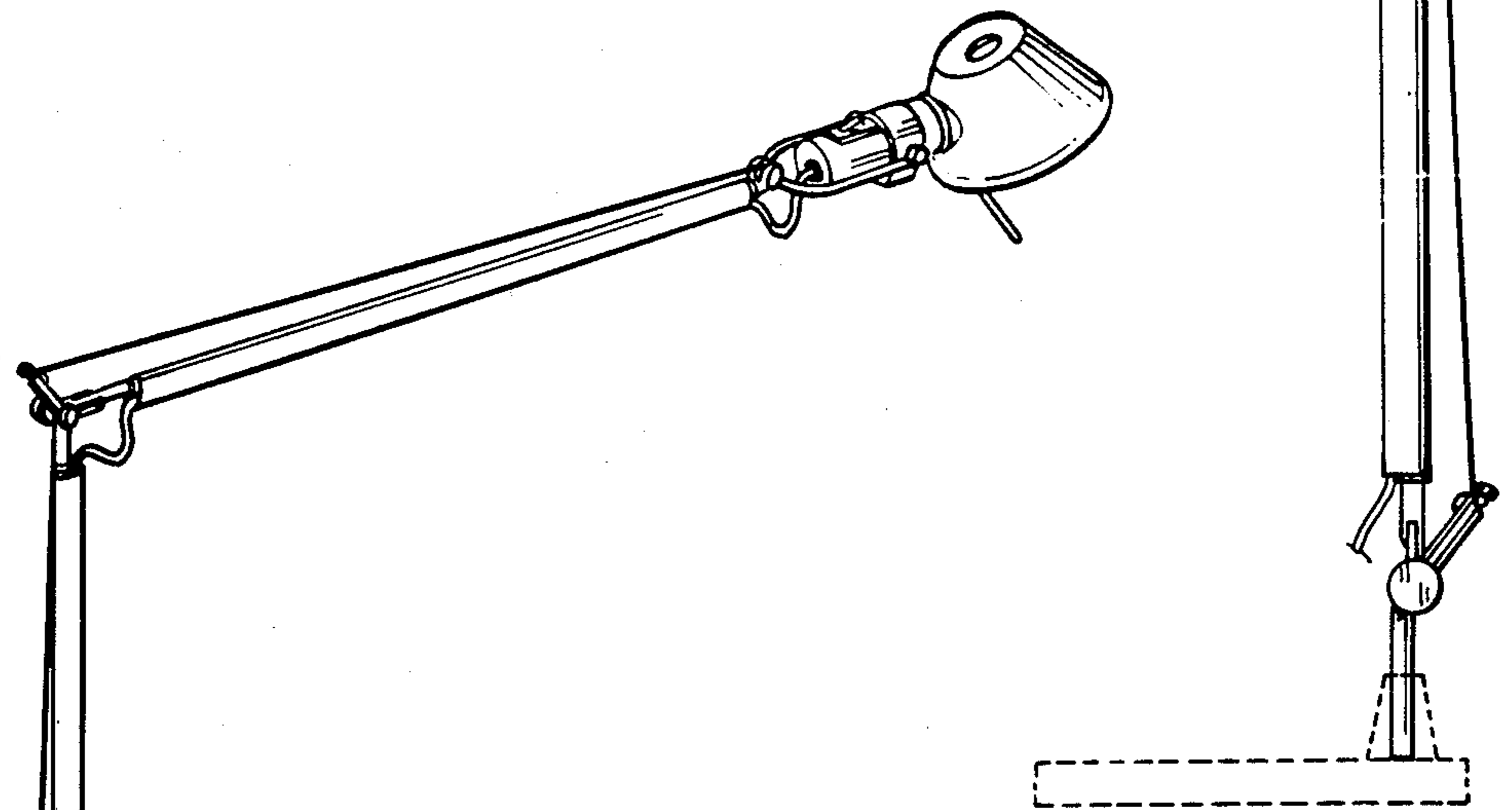
**DESCRIPTION**

FIG. 1 is a top, perspective view of an adjustable table lamp showing my new design;  
FIG. 2 is a side elevational view thereof on an enlarged scale;  
FIG. 3 is a front elevational view thereof on an enlarged scale;  
FIG. 4 is a rear elevational view thereof on an enlarged scale;  
FIG. 5 is an opposite side elevational view thereof on an enlarged scale;  
FIG. 6 is a top plan view thereof on an enlarged scale;  
FIG. 7 is a bottom plan view thereof on an enlarged scale.  
The base plate is shown in broken lines for purposes of illustration only.

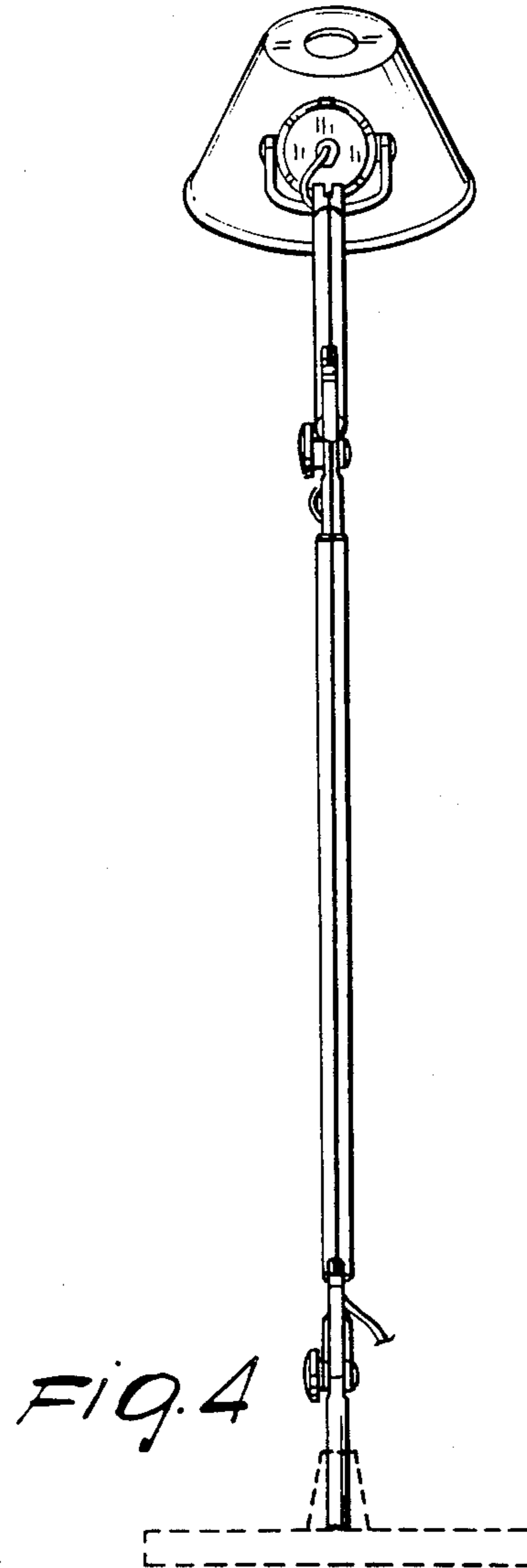
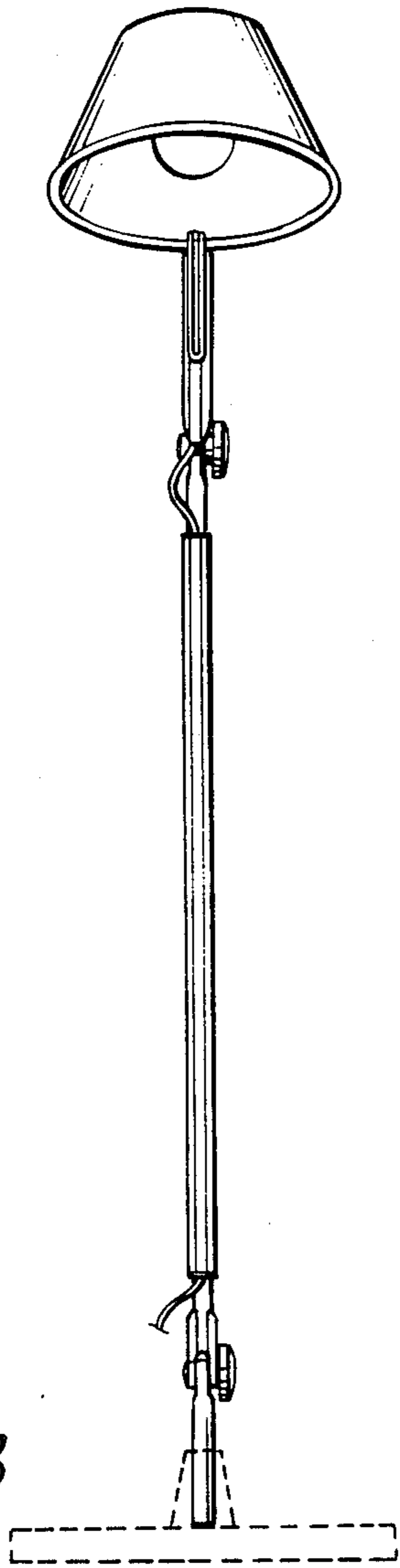
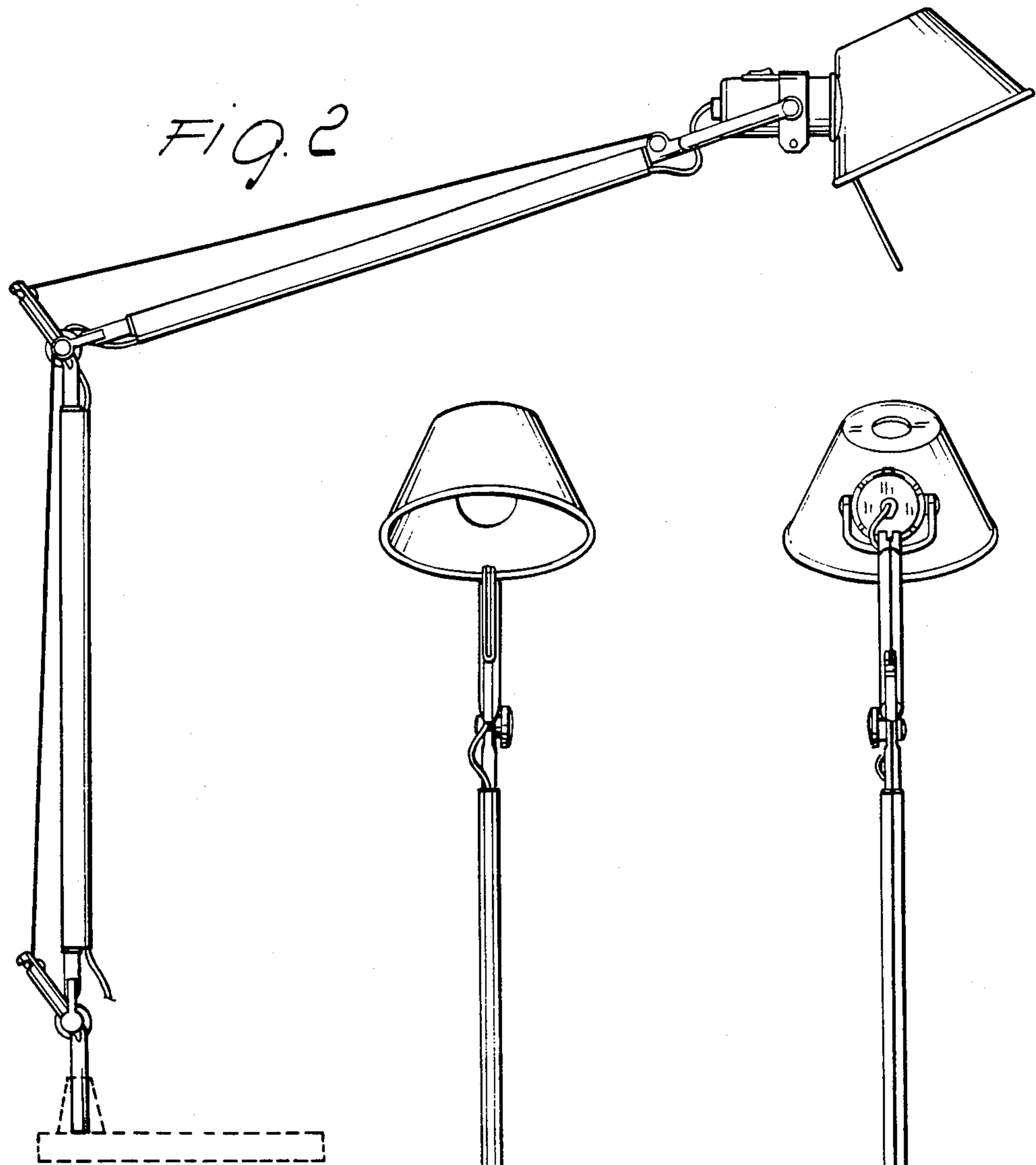




*Fig. 1*



*Fig. 5*



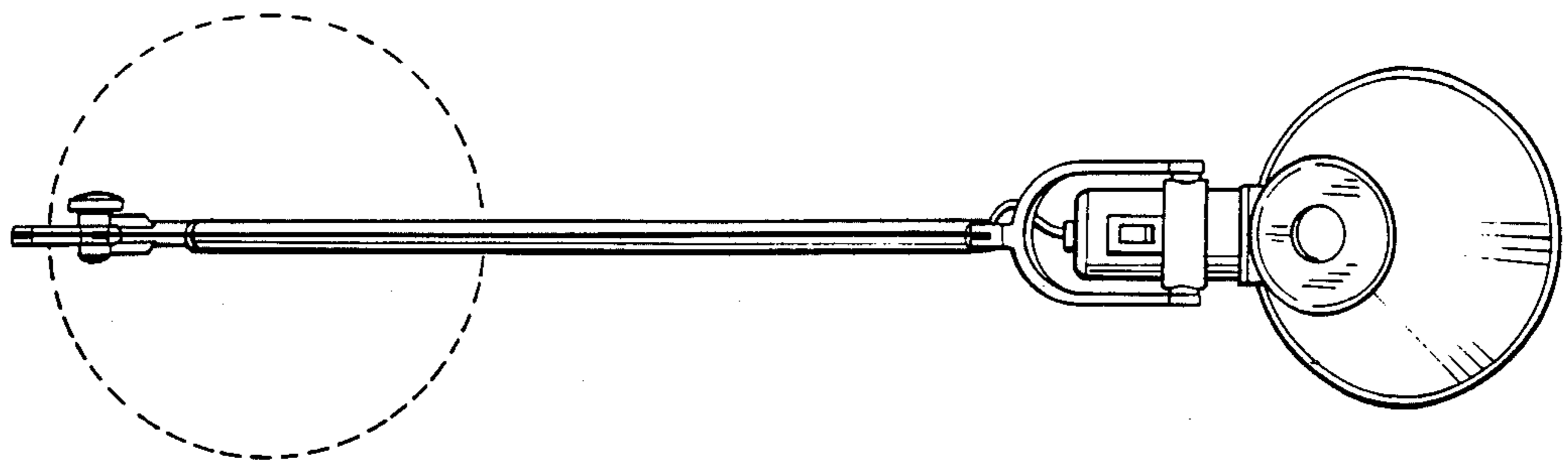


FIG. 6

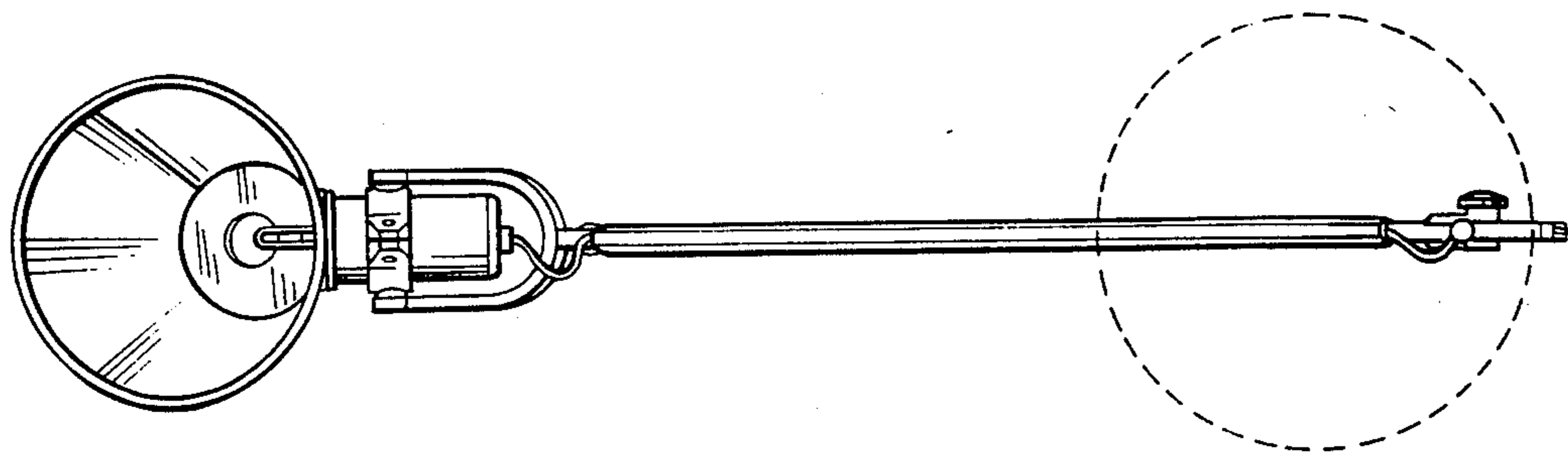


FIG. 7