

[54] MINI-SOLE GOLF CLUB

DESCRIPTION

[76] Inventor: James D. Giambazi, 12 Abbott St.,
Cumberland, R.I. 02864

[**] Term: 14 Years

[21] Appl. No.: 803,494

[22] Filed: Dec. 2, 1985

[52] U.S. Cl. D21/220

[58] Field of Search D21/214-220;
273/167-175, 164

FIG. 1 is a front perspective view of a golf club embodying my new design;
FIG. 2 is a fragmentary front perspective view of the golf club embodying my new design and showing the head of the club;
FIG. 3 is a fragmentary rear perspective view thereof;
FIG. 4 is a fragmentary top view thereof;
FIG. 5 is a fragmentary front elevation view thereof;
FIG. 6 is a fragmentary front end elevation view thereof;
FIG. 7 is a fragmentary rear end elevation view thereof;
FIG. 8 is a fragmentary rear elevation view thereof;
FIG. 9 is a fragmentary bottom view thereof;
FIG. 10 is a fragmentary front end elevation view of another embodiment of my new design;
FIG. 11 is a fragmentary front end elevation view of another embodiment of my new design;
FIG. 12 is a fragmentary front end elevation view of another embodiment of my new design;
FIG. 13 is a fragmentary front elevation view of another embodiment of my new design;
FIG. 14 is a fragmentary front elevation view of another embodiment of my new design;
FIG. 15 is a fragmentary front elevation view of another embodiment of my new design;
FIG. 16 is a fragmentary front elevation view of another embodiment of my new design;
FIG. 17 is a fragmentary front elevation view of another embodiment of my new design;
FIG. 18 is a fragmentary front elevation view of another embodiment of my new design; and
FIG. 19 is a fragmentary front elevation view of another embodiment of my new design.
The embodiments shown in FIGS. 10 through 19 are the same in appearance as the views shown in FIGS. 1 through 9 except for the angle of the club head face.

[56] References Cited

U.S. PATENT DOCUMENTS

D. 215,608	10/1969	Lysaght	D21/220
D. 240,841	8/1976	Solheim	D34/5 GC
1,541,126	6/1925	Dunn	.	
3,138,386	6/1964	Onions	273/167
3,166,320	1/1965	Onions	273/80
3,810,631	5/1974	Braly	273/167 A
3,862,759	1/1975	Evans et al.	273/167 A

FOREIGN PATENT DOCUMENTS

455632	10/1936	United Kingdom	273/167 A
--------	---------	----------------	-------	-----------

Primary Examiner—Melvin B. Feifer
Attorney, Agent, or Firm—Neuman, Williams, Anderson & Olson

[57] CLAIM

The ornamental design for a mini-sole golf club, as shown and described.

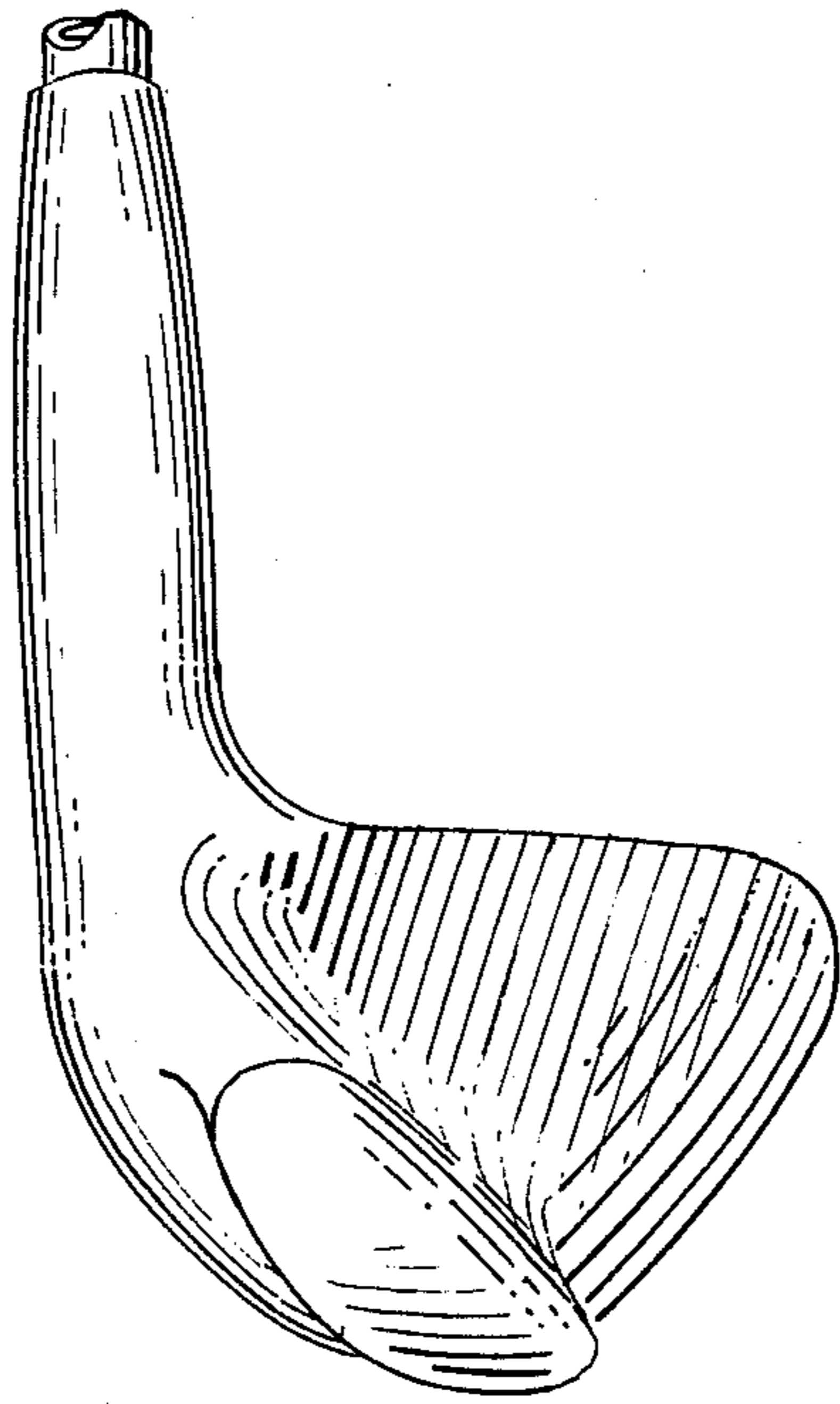

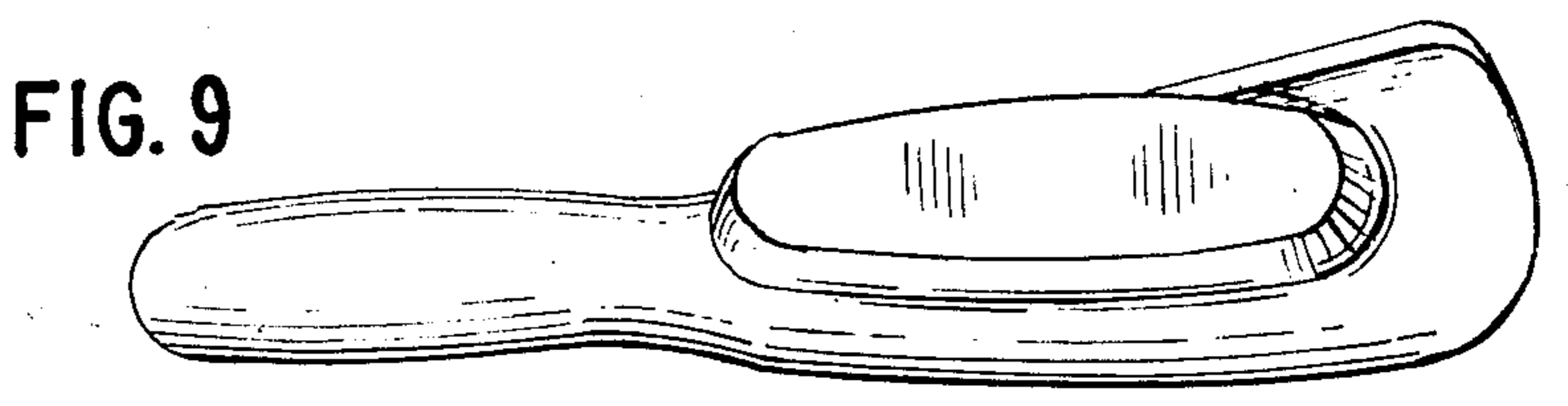
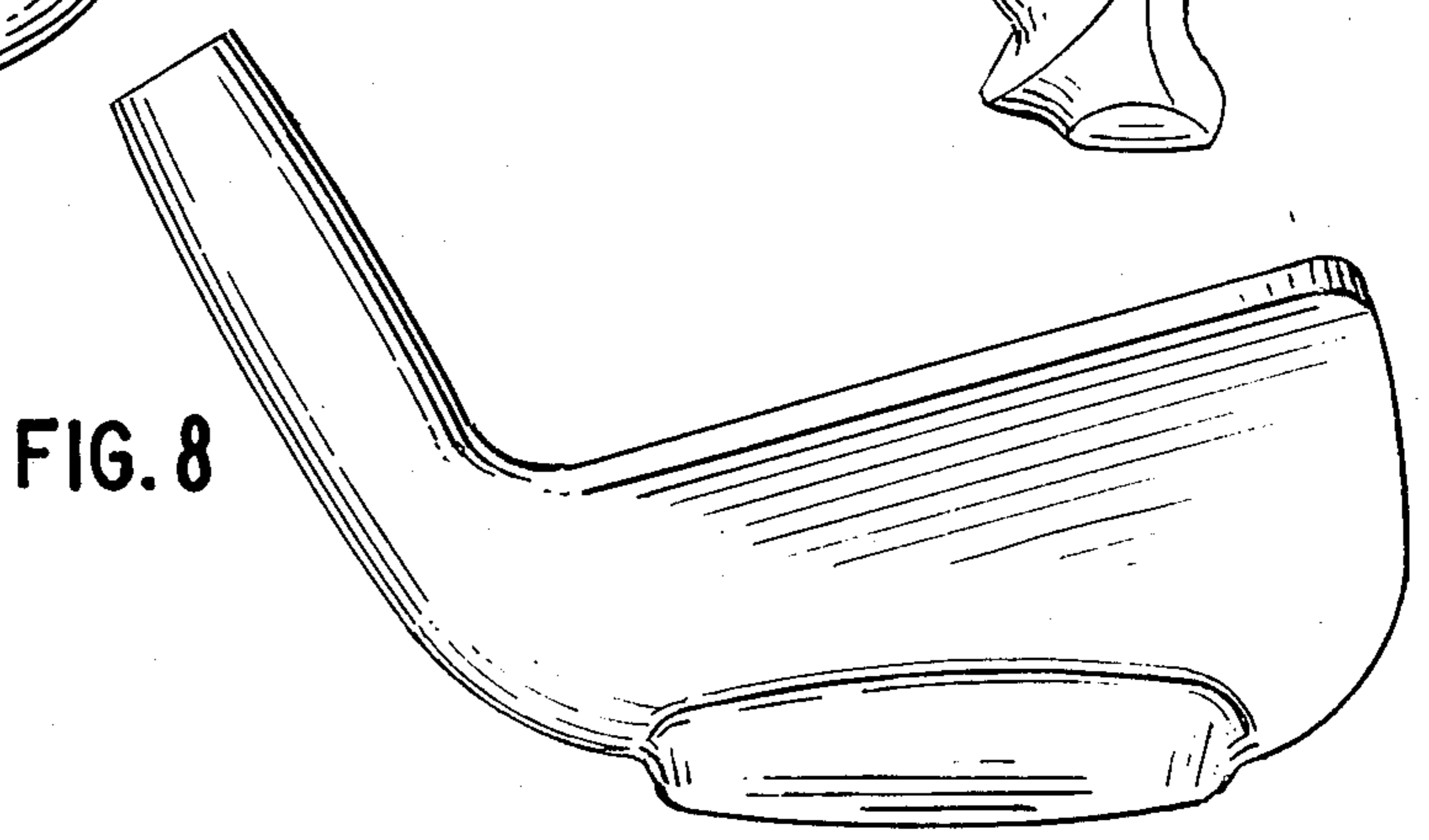
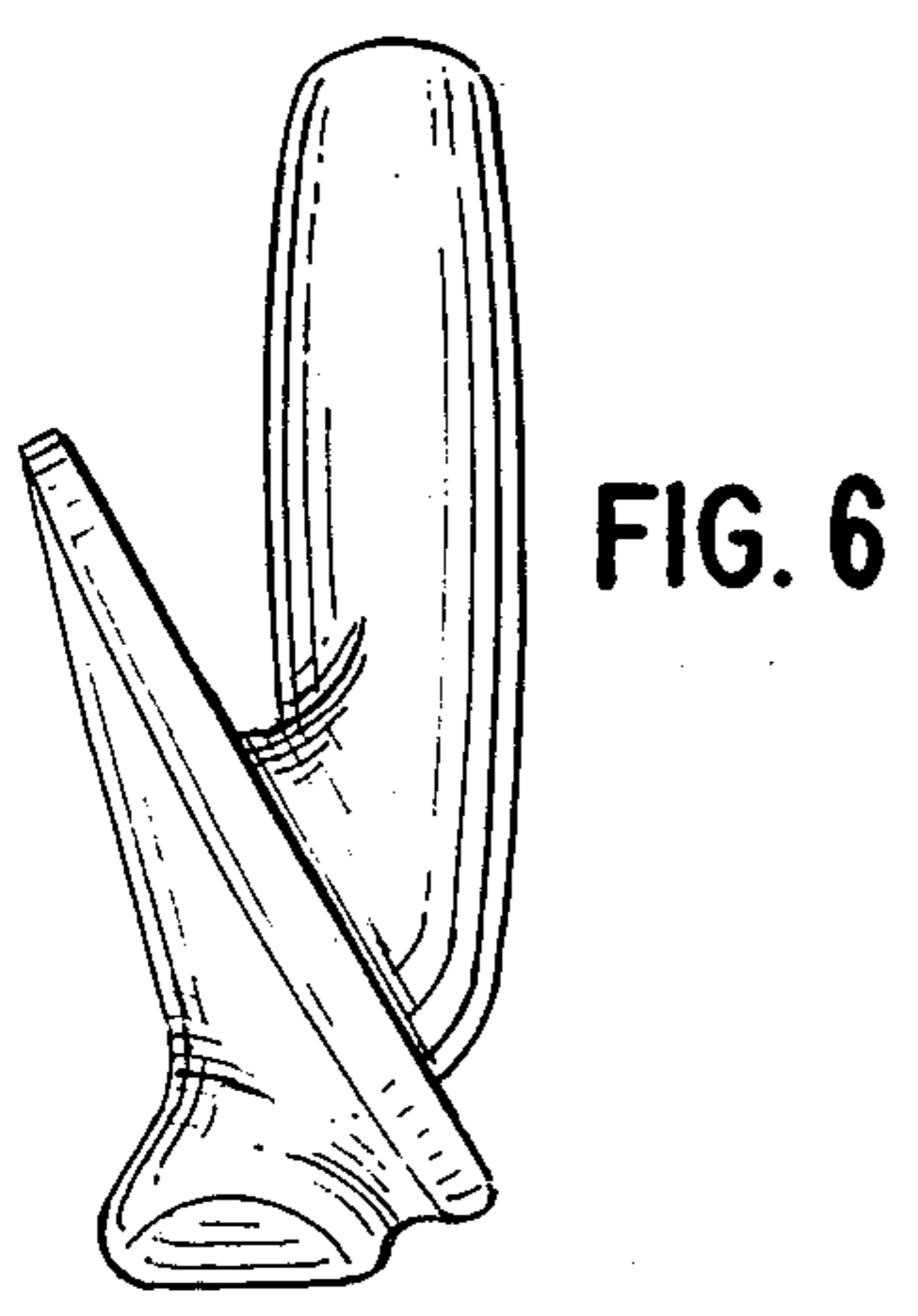
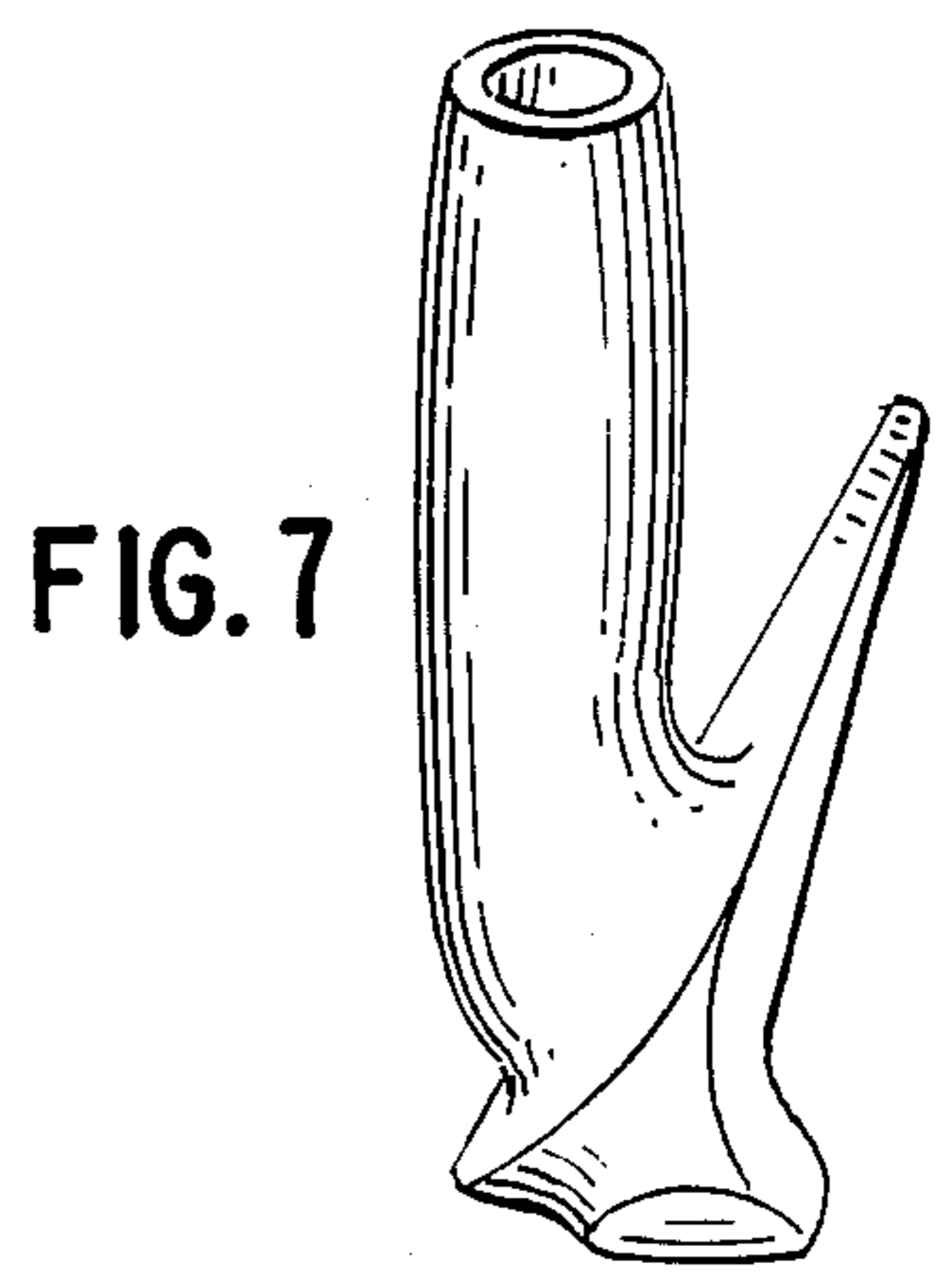
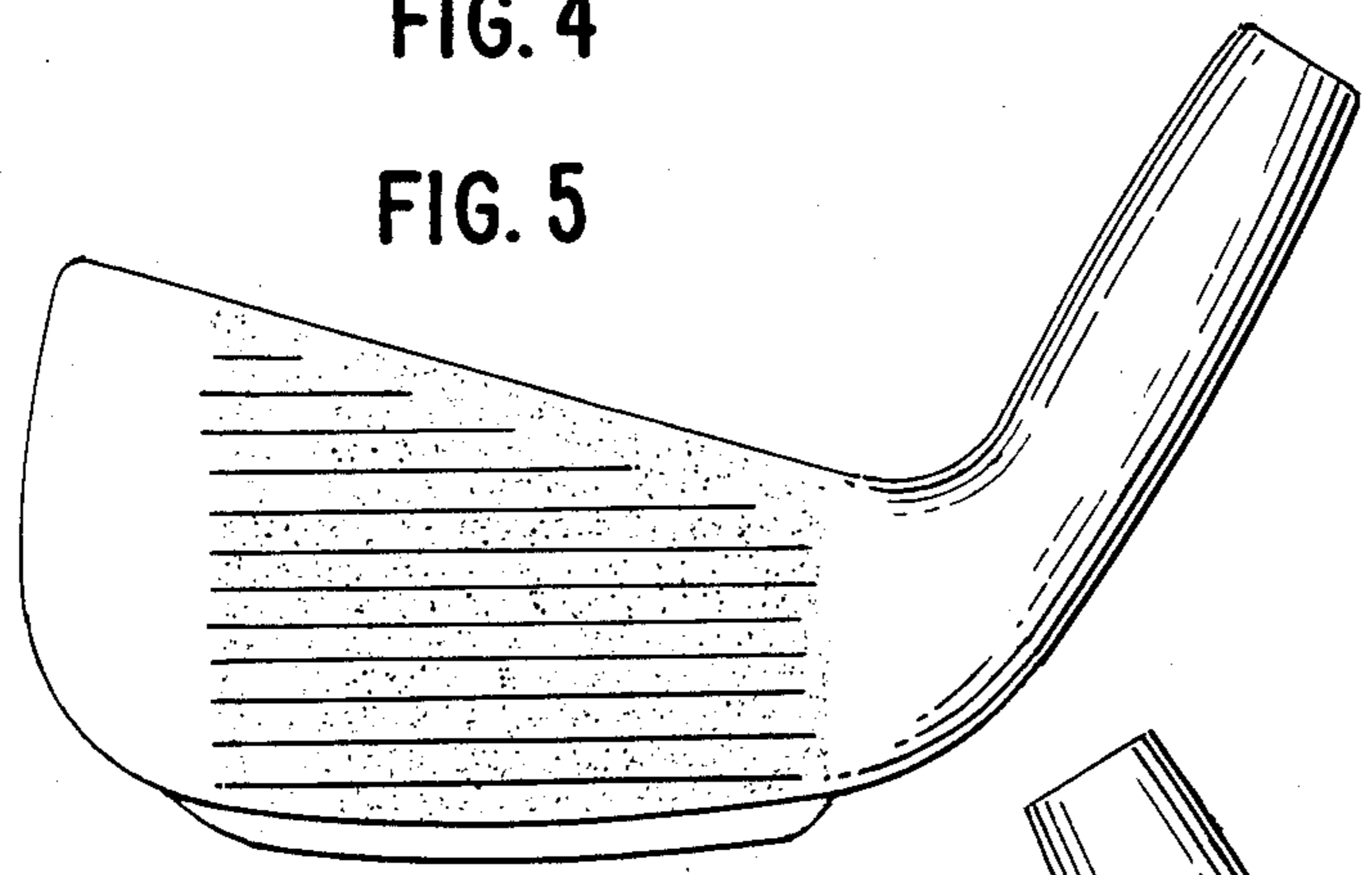
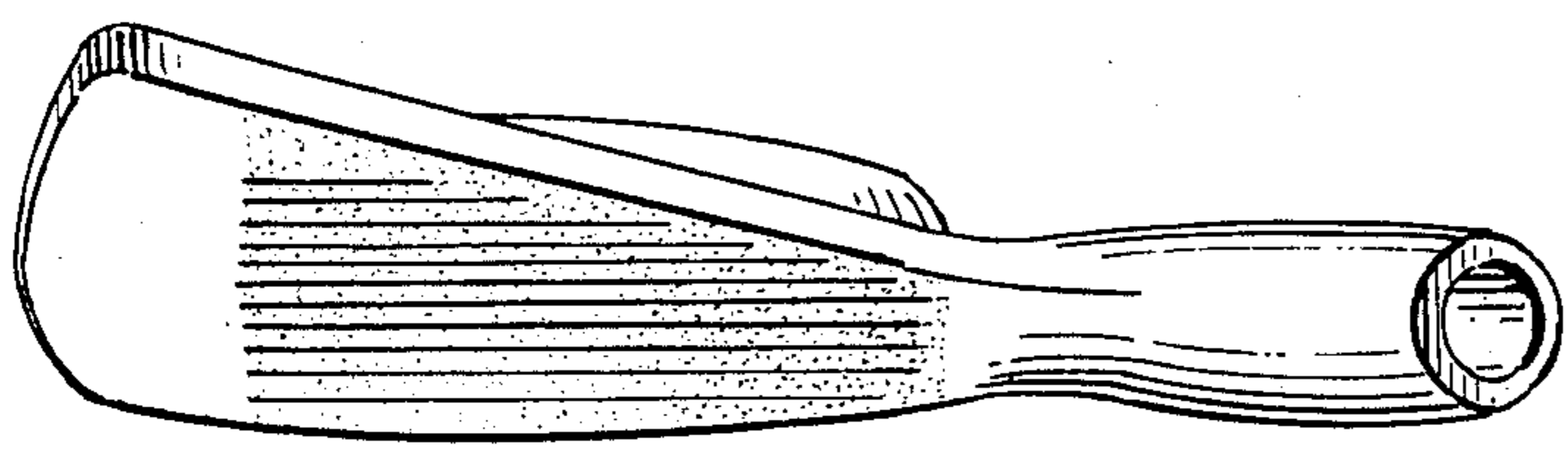
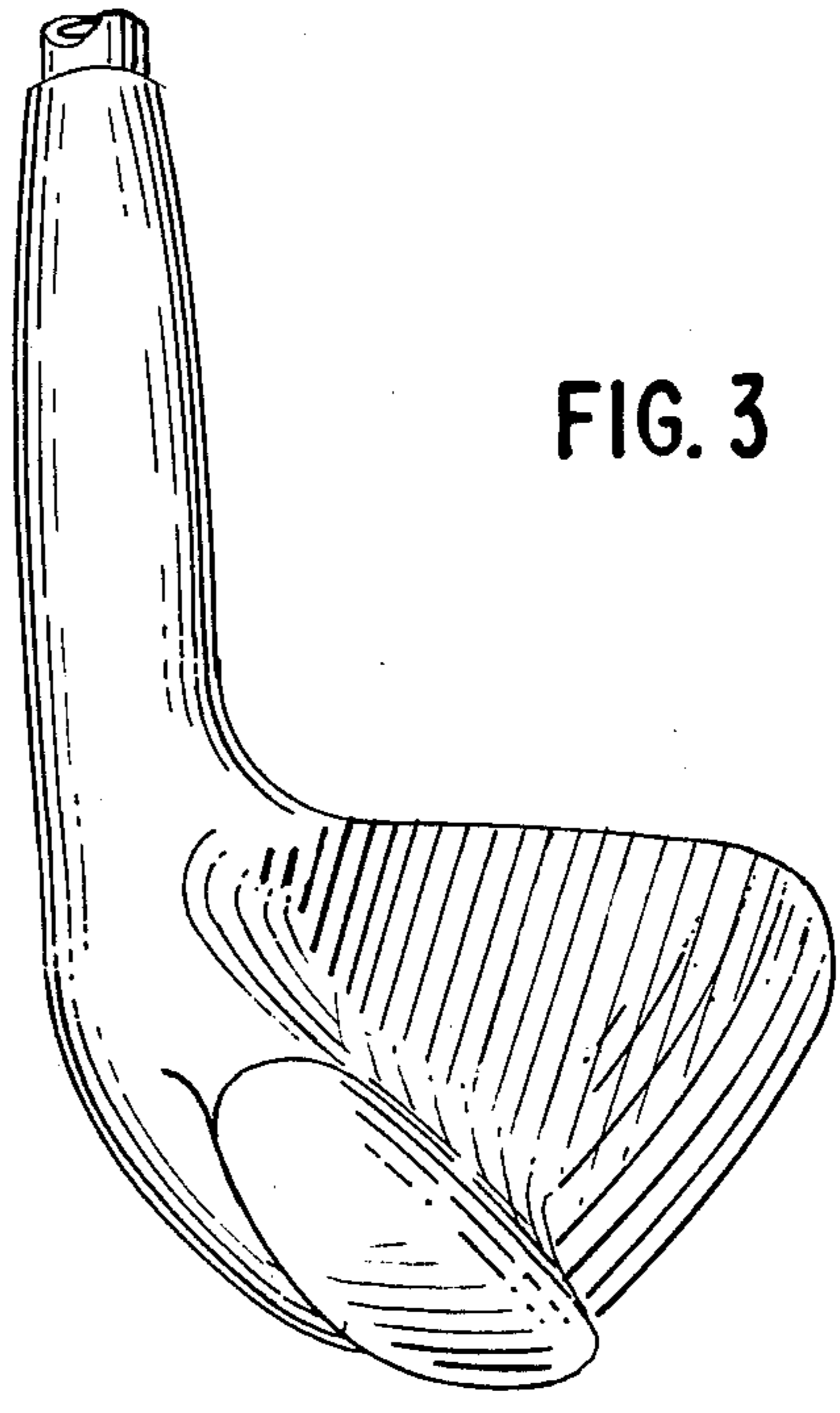
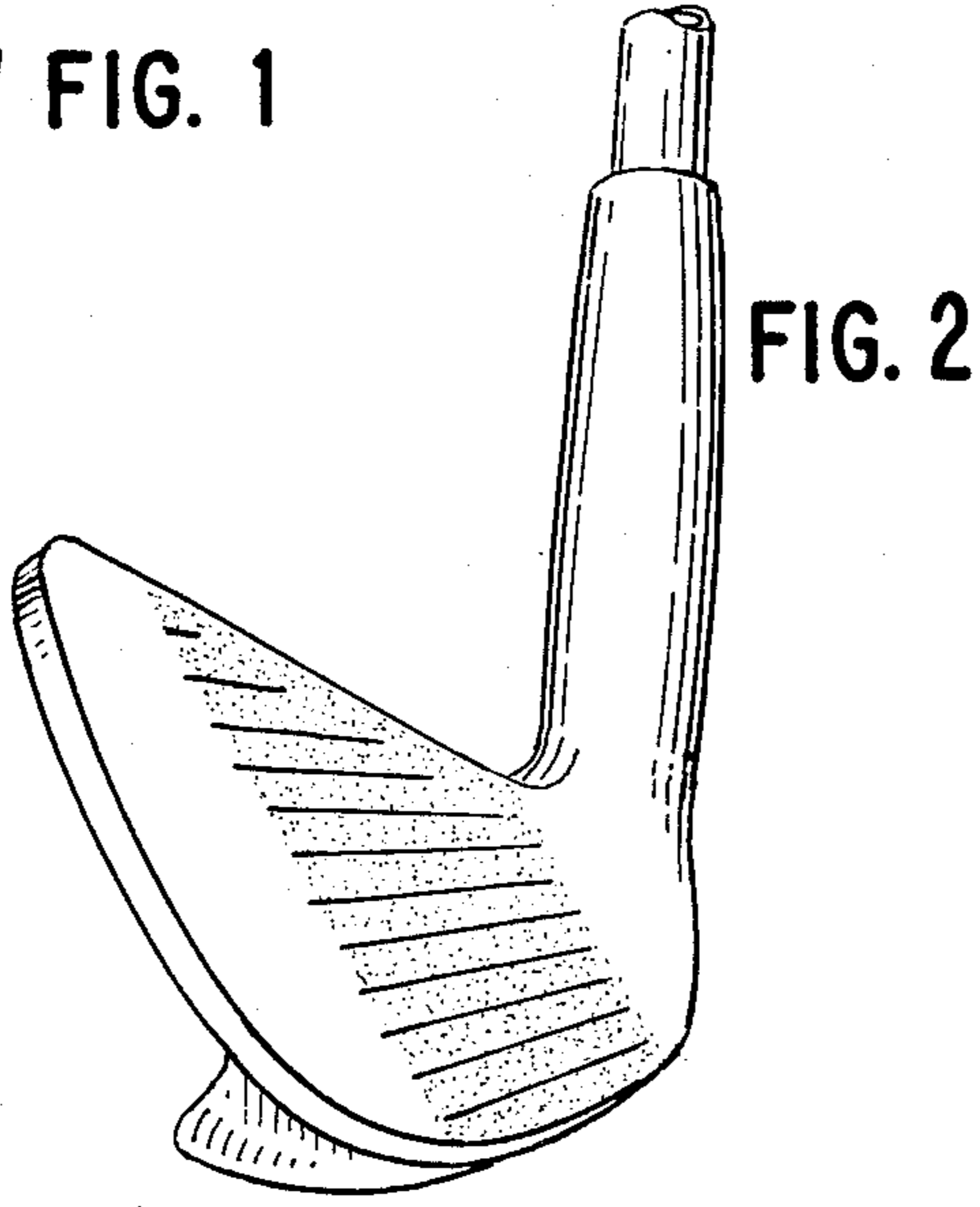
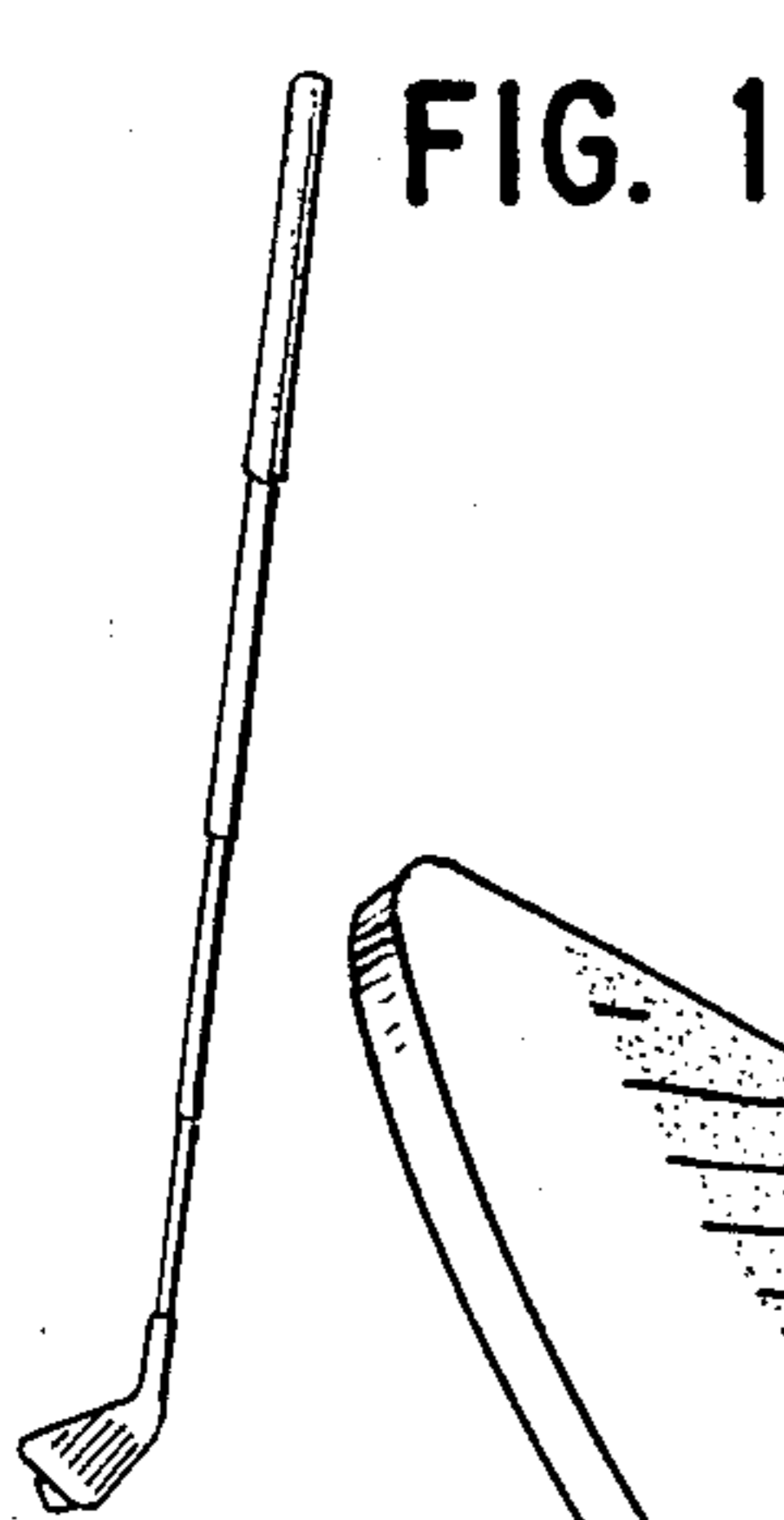

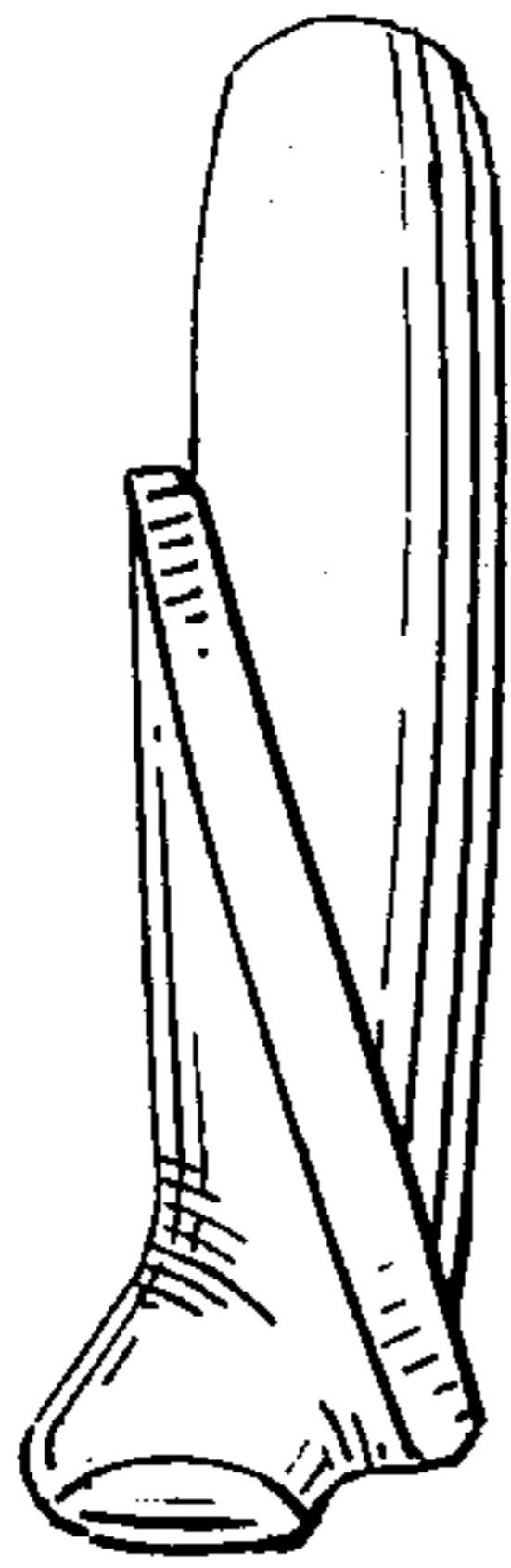

FIG. 10

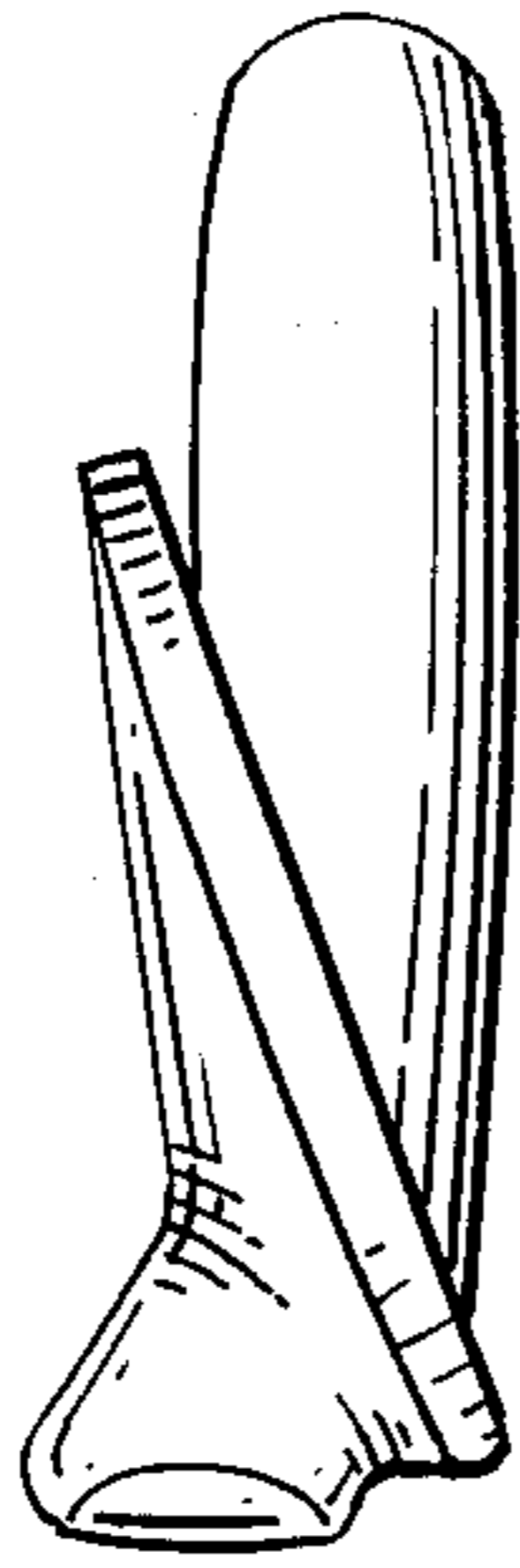

FIG. 11

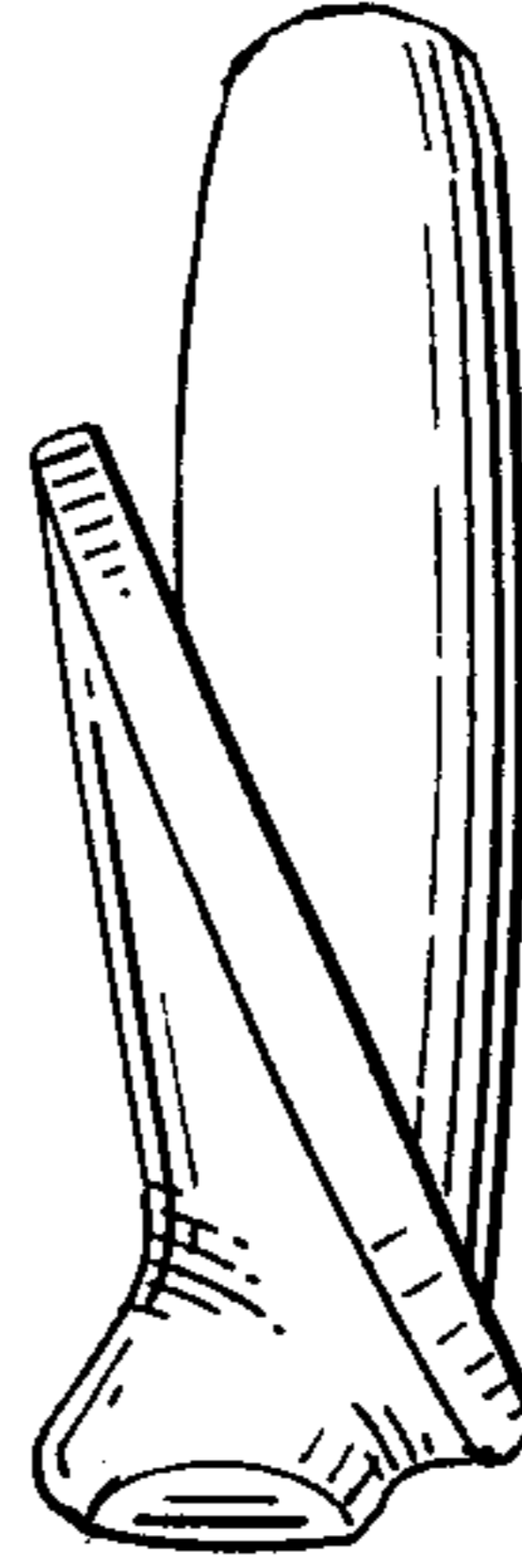

FIG. 12

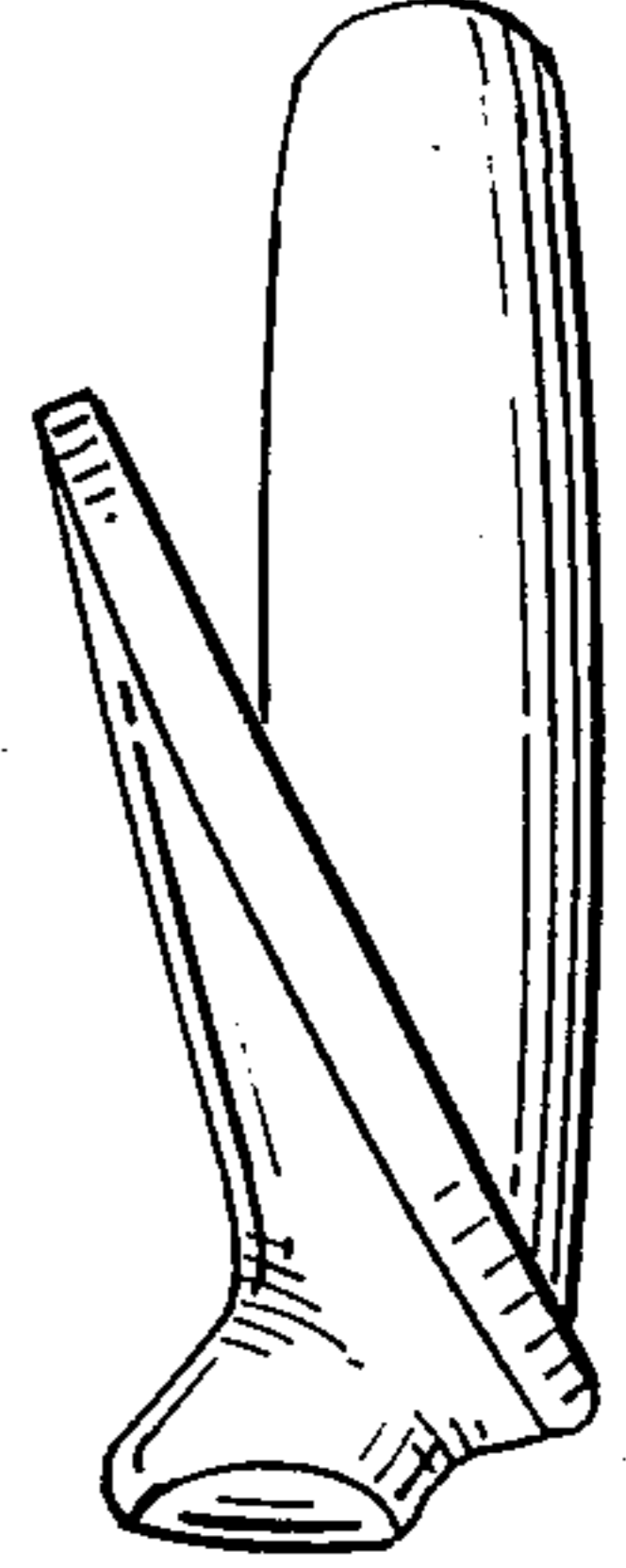

FIG. 13

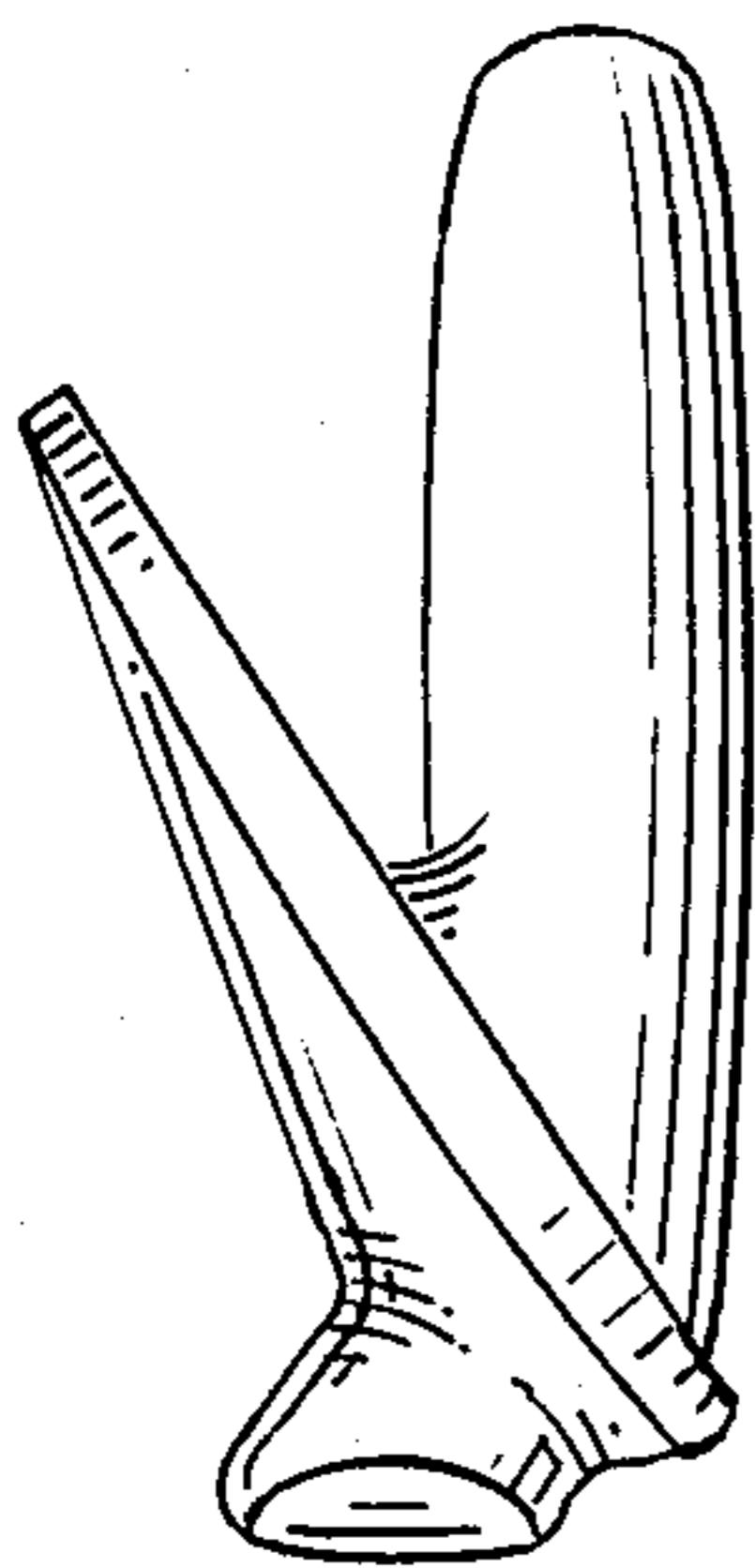

FIG. 14

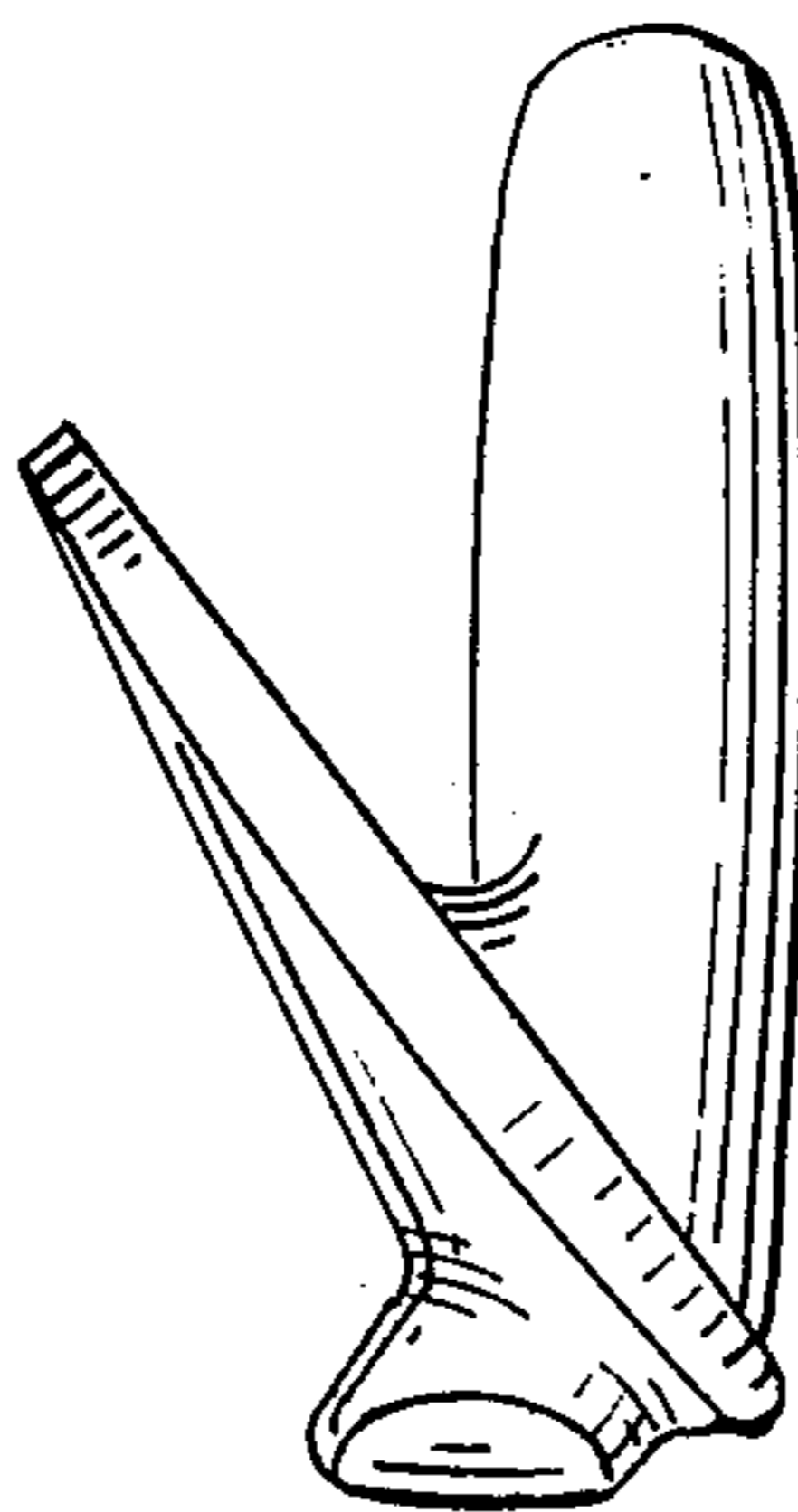

FIG. 15

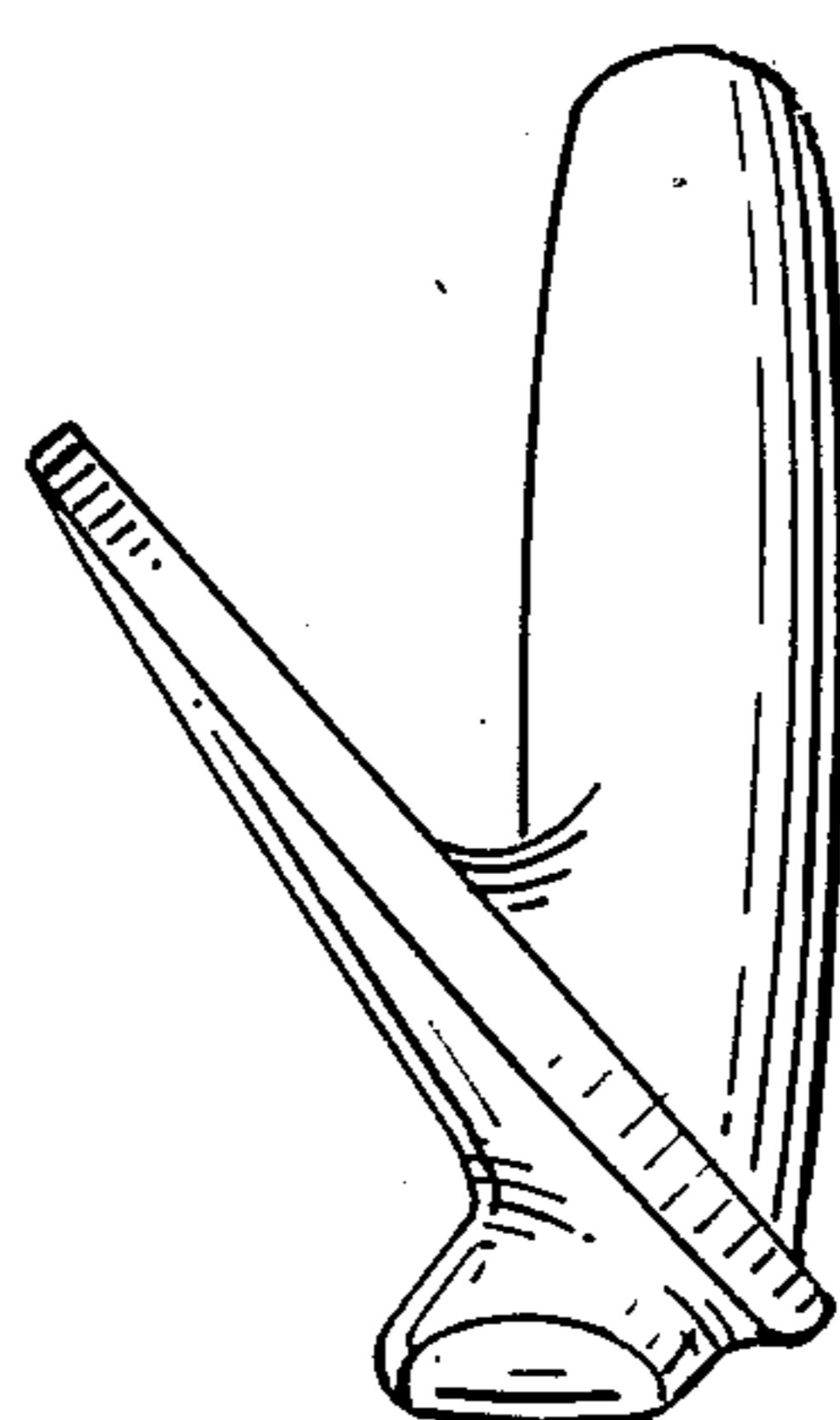

FIG. 16

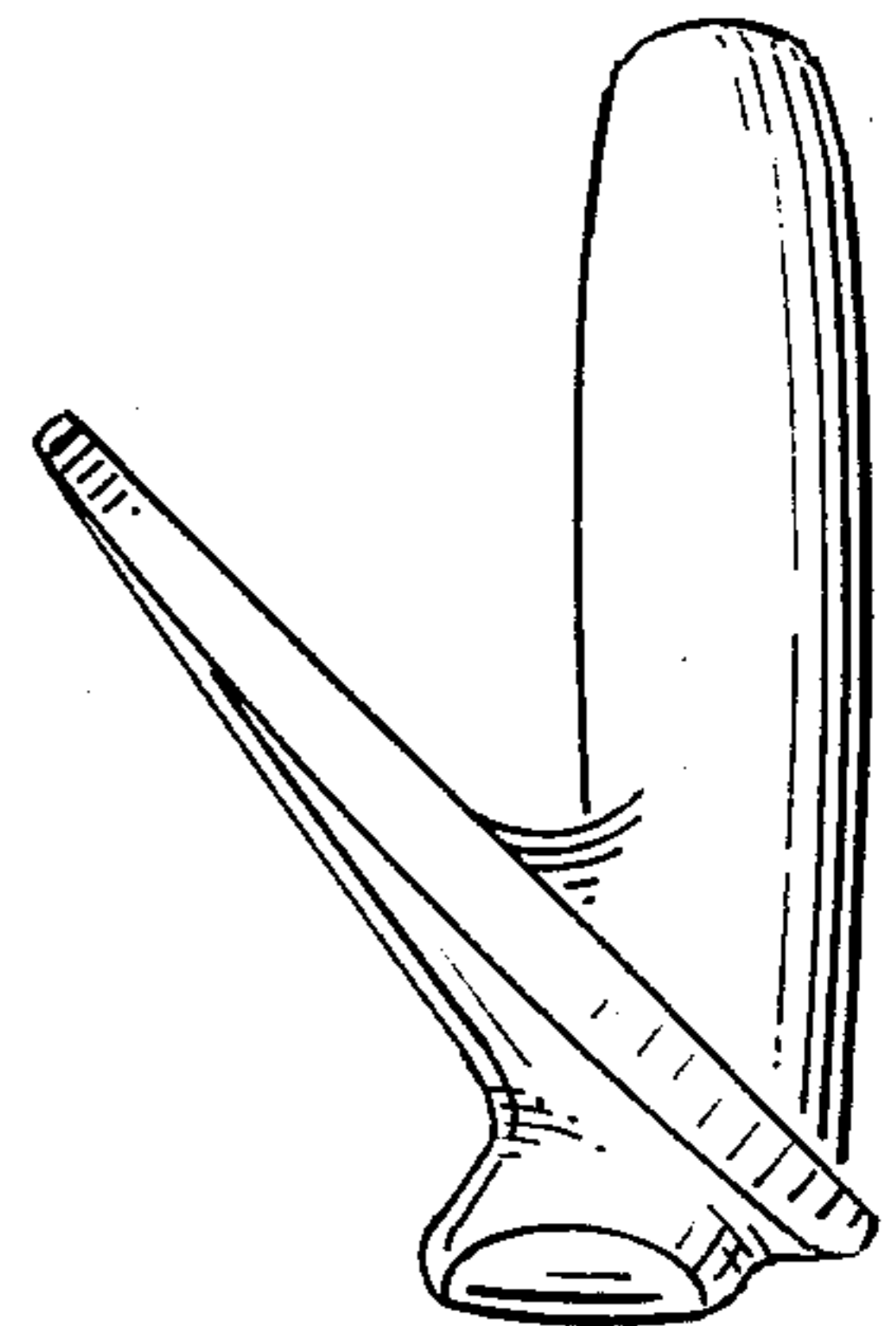

FIG. 17

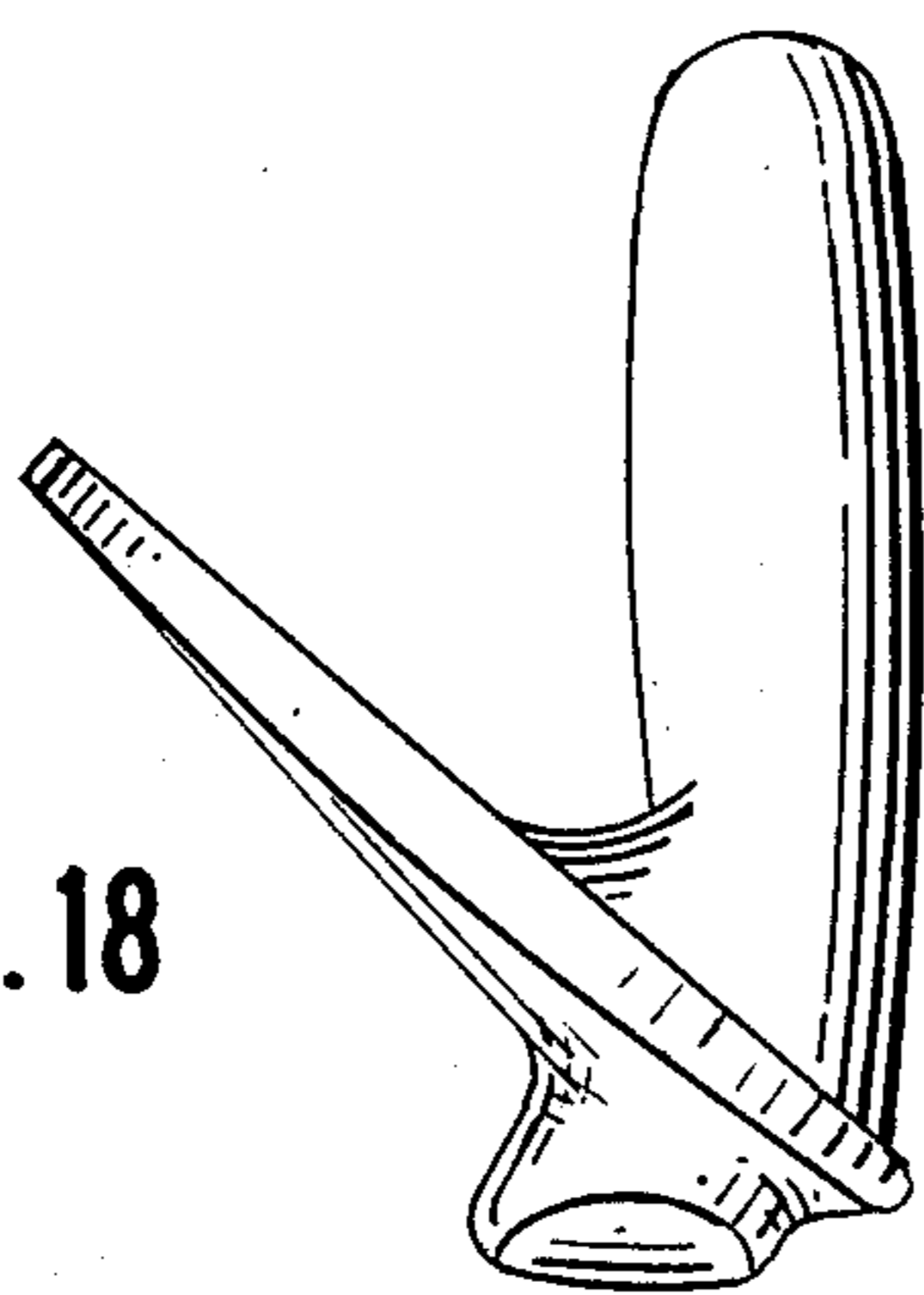

FIG. 18

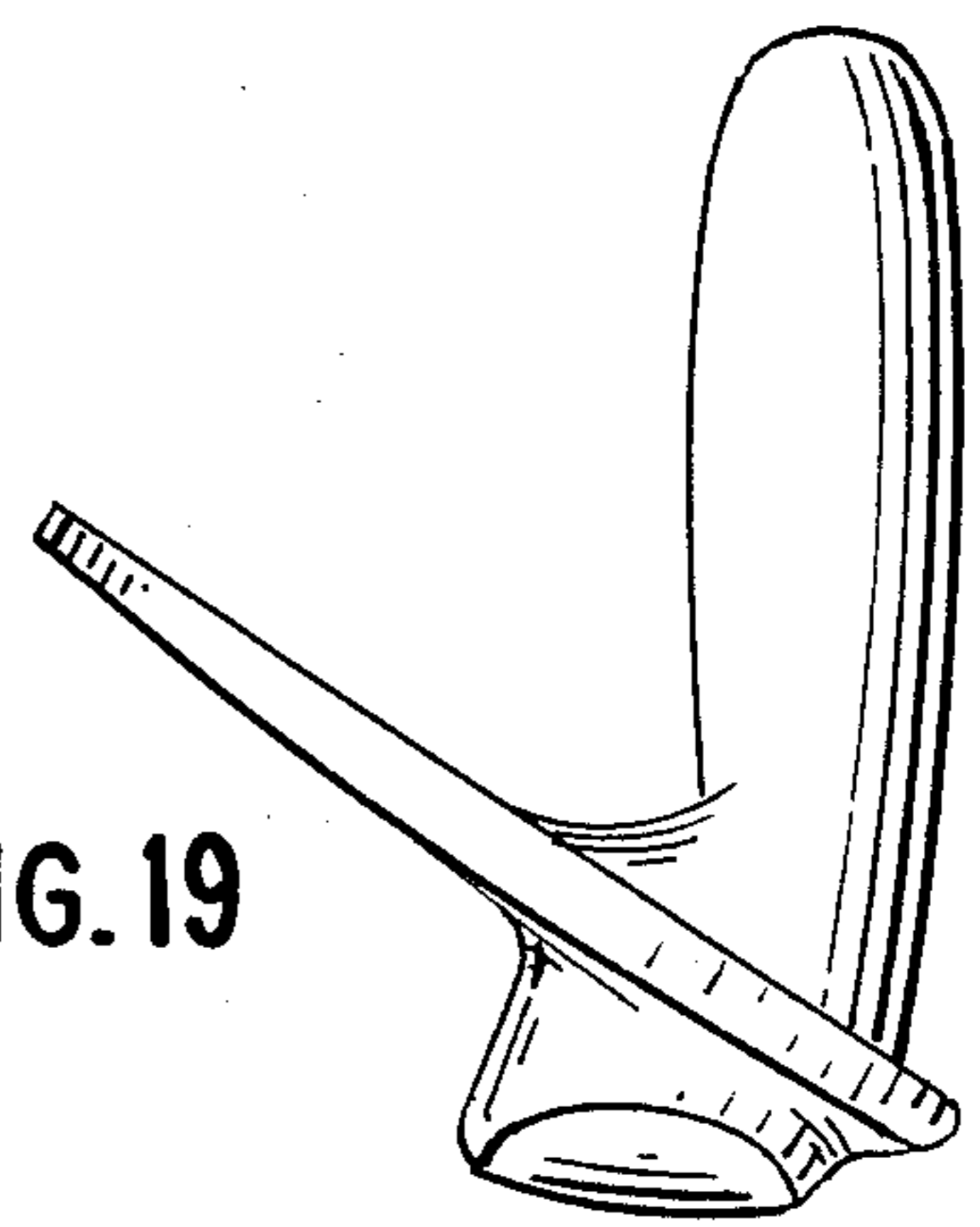

FIG. 19