

[54] COMBINED I.C. PORTABLE AM-FM RADIO, SPOTLIGHT AND BLINKING LIGHT

[75] Inventor: John S. Yuen, Kowloon, Hong Kong

[73] Assignee: John Manufacturing Limited, Kowloon, Hong Kong

[\*\*] Term: 14 Years

[21] Appl. No.: 851,399

[22] Filed: Apr. 10, 1986

[30] Foreign Application Priority Data

Oct. 14, 1985 [GB] United Kingdom ..... 1029821

[52] U.S. Cl. .... D14/168; D14/195; D26/38

[58] Field of Search ..... D14/5, 6, 7, 68-76, D14/95, 96, 99; 455/344, 347, 350, 351; D26/38

[56] References Cited

U.S. PATENT DOCUMENTS

- D. 253,822 1/1980 Hamada et al. .... D14/70
- D. 273,382 4/1984 Okada et al. .... D14/71
- D. 280,442 9/1985 Ohashi ..... D26/38

- D. 288,201 2/1987 Fink ..... D14/68
- D. 294,698 3/1988 Yuen ..... D14/70
- D. 296,243 6/1988 Ohashi ..... D26/38

Primary Examiner—Bernard Ansher  
Assistant Examiner—Theodore M. Shooman  
Attorney, Agent, or Firm—Fay, Sharpe, Beall, Fagan, Minnich & McKee

[57] CLAIM

The ornamental design for combined I.C. portable AM-FM radio, spotlight and blinking light, as shown and described.

DESCRIPTION

FIG. 1 is a front elevational view of combined I.C. portable AM-FM radio, spotlight and blinking light showing my new design;  
FIG. 2 is a rear elevational view thereof;  
FIG. 3 is a right side elevational view thereof the left side being a mirror image;  
FIG. 4 is a bottom plan view thereof;  
FIG. 5 is a top plan view thereof;  
FIG. 6 is a sectional view thereof, taken along line 6—6 of FIG. 7; and  
FIG. 7 is a front elevational view thereof, with the handle raised.

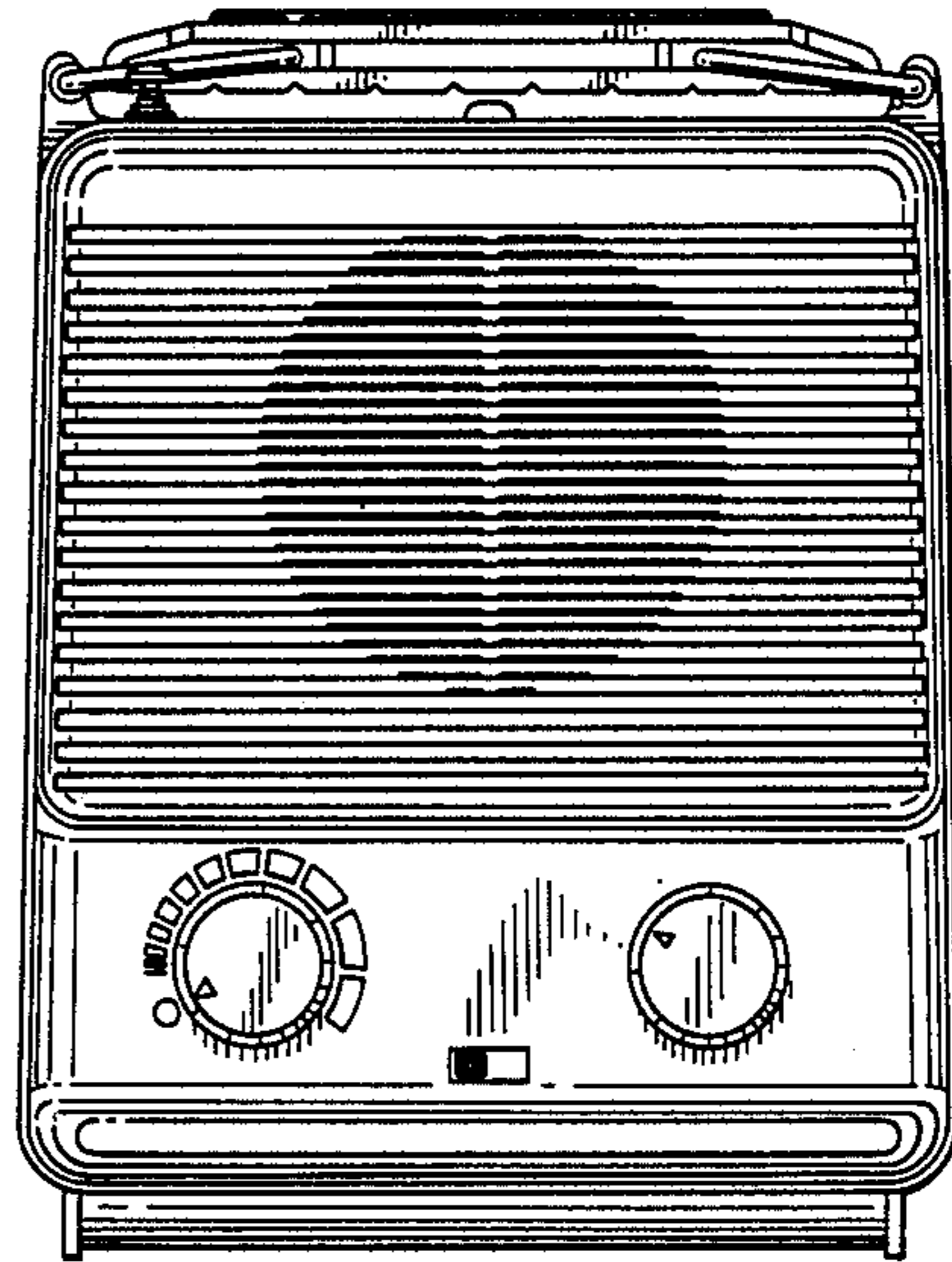
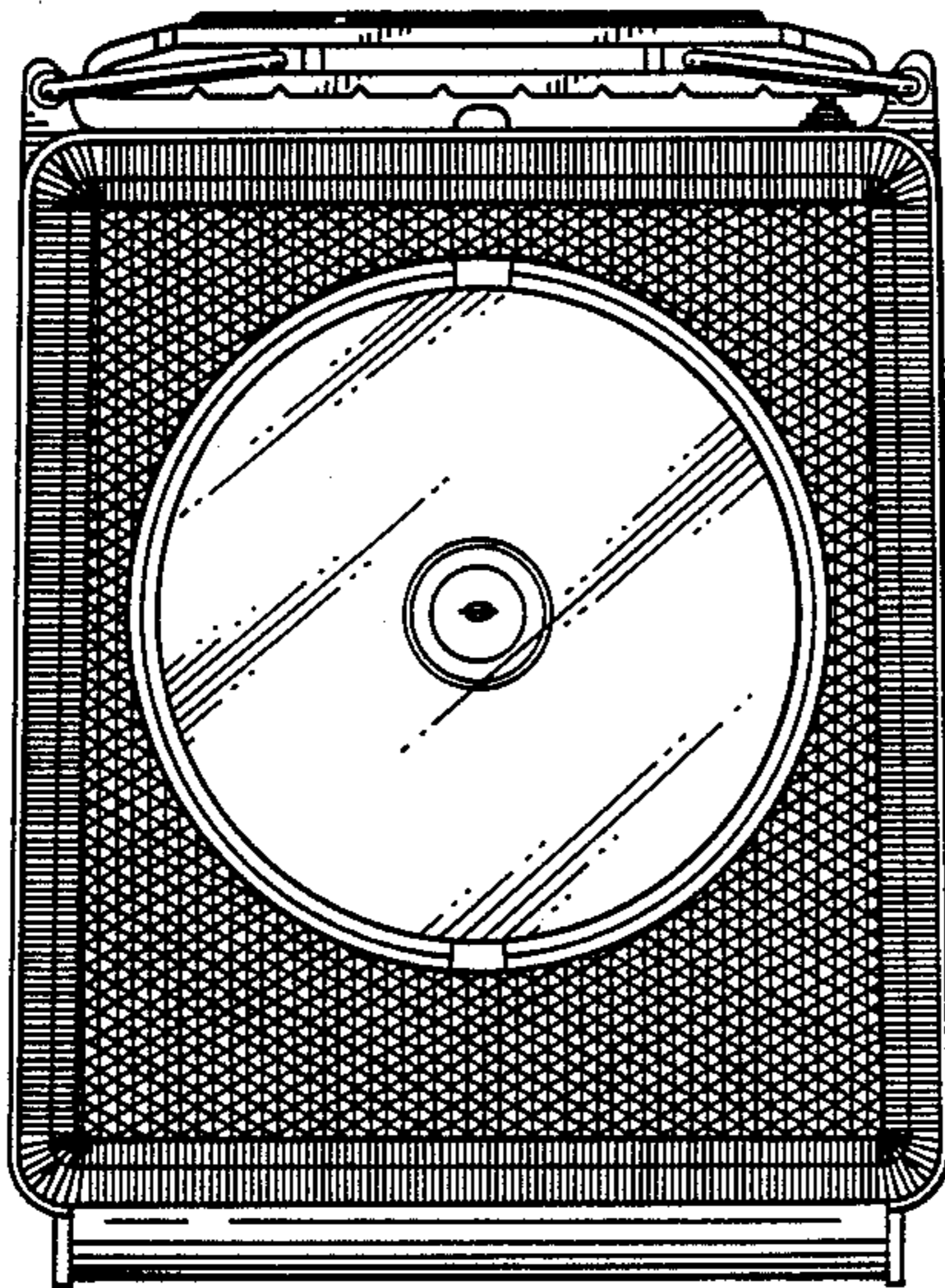

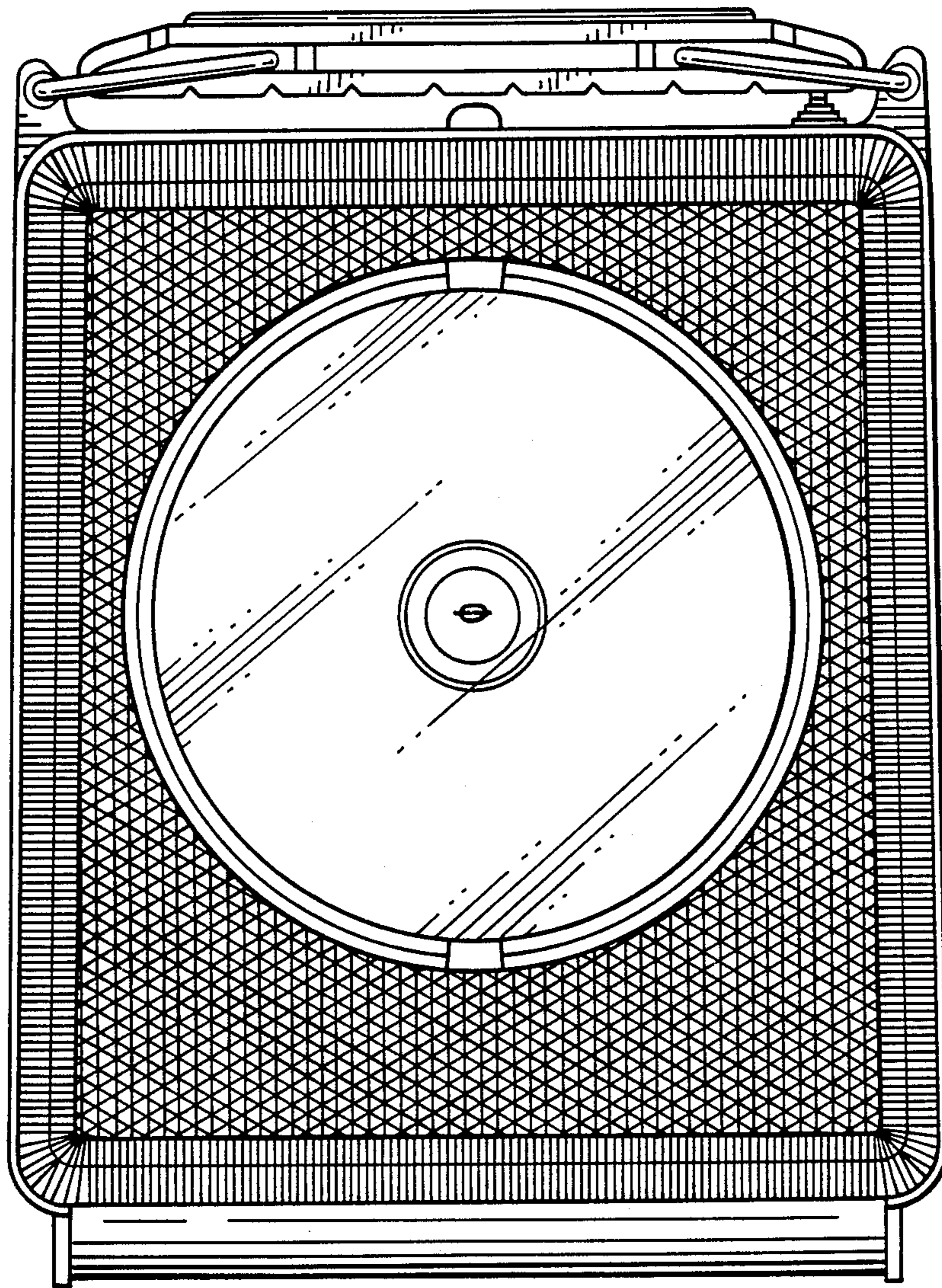

FIG. 1

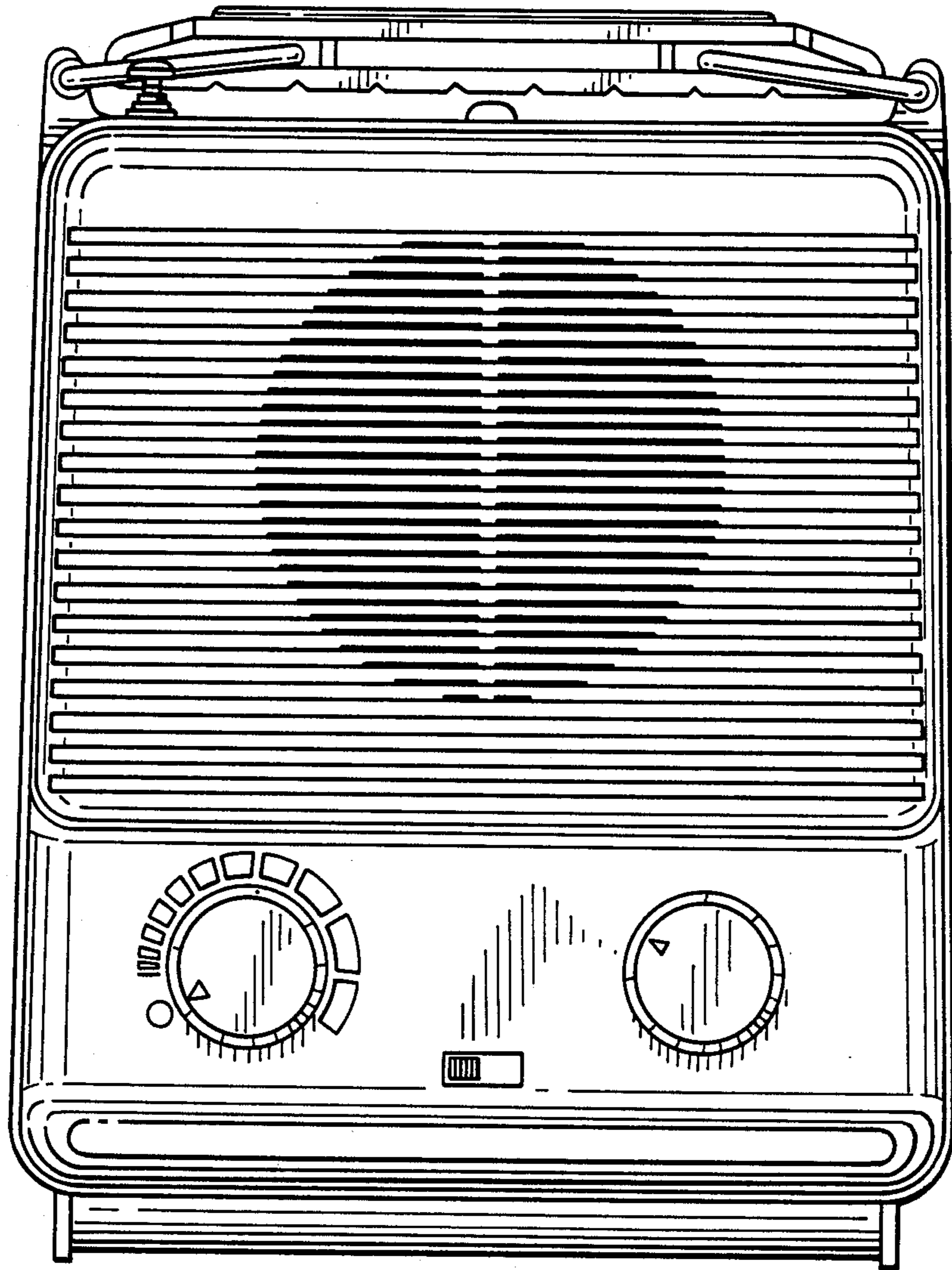

FIG. 2

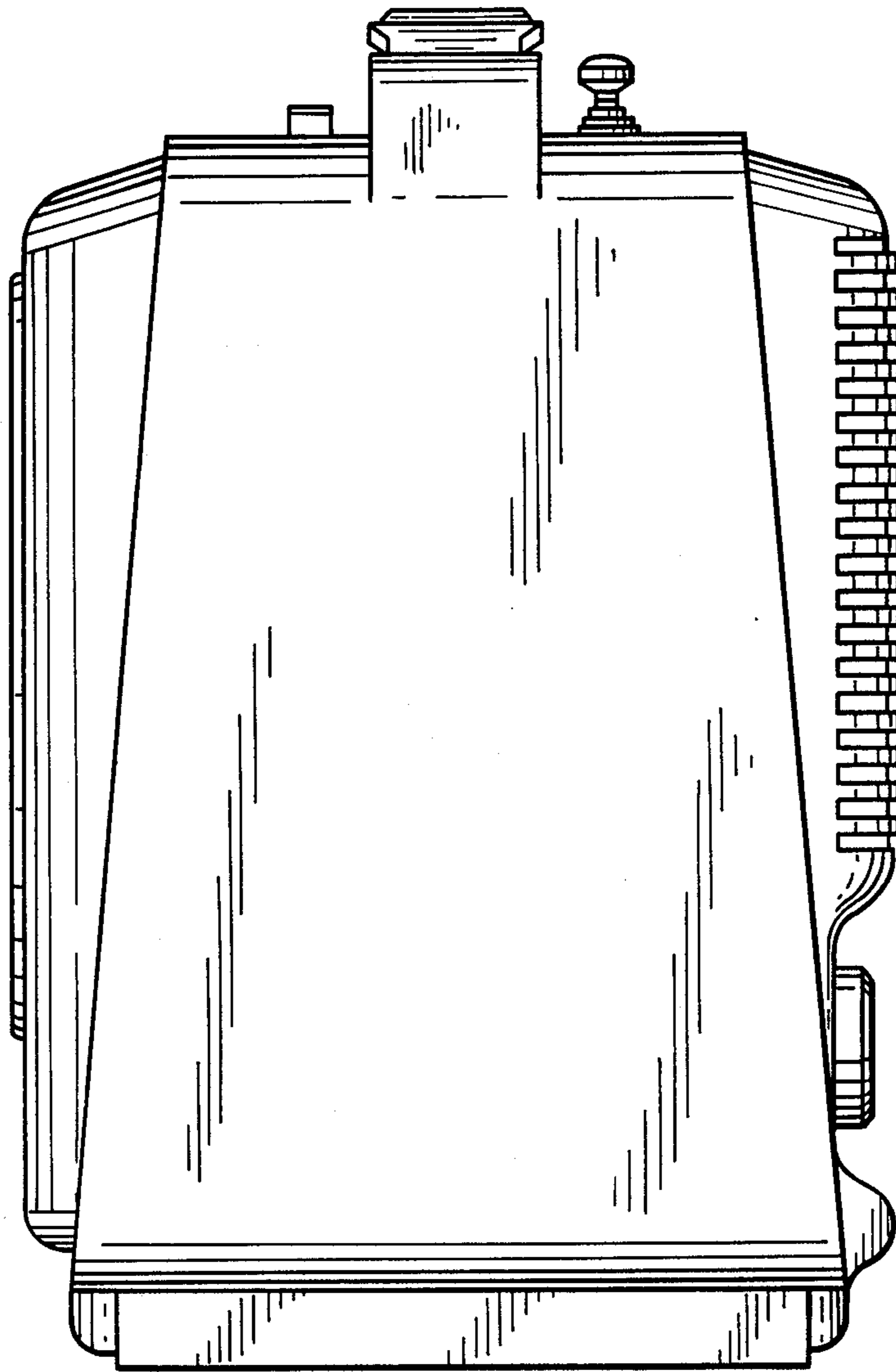

FIG. 3

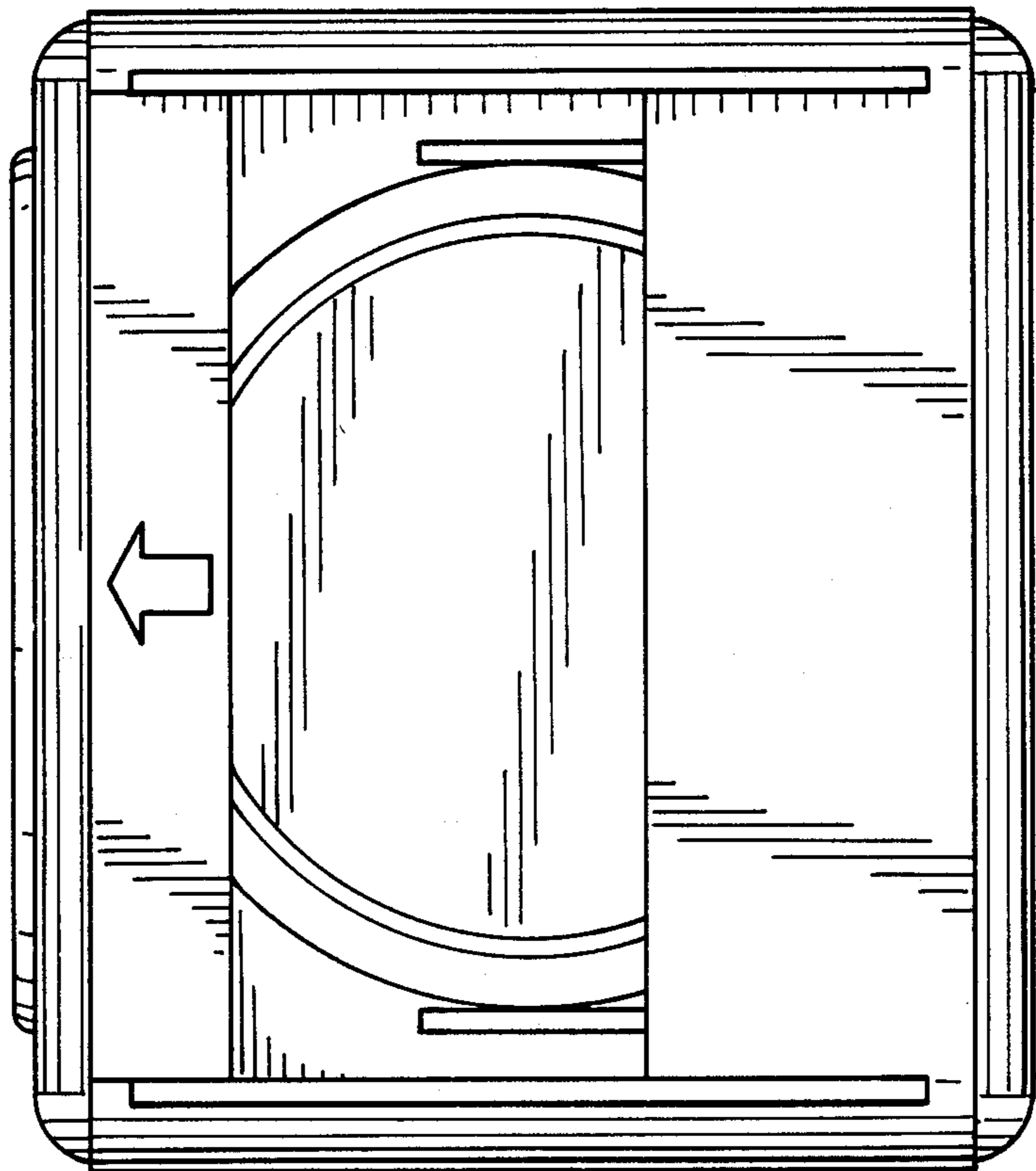

FIG. 4

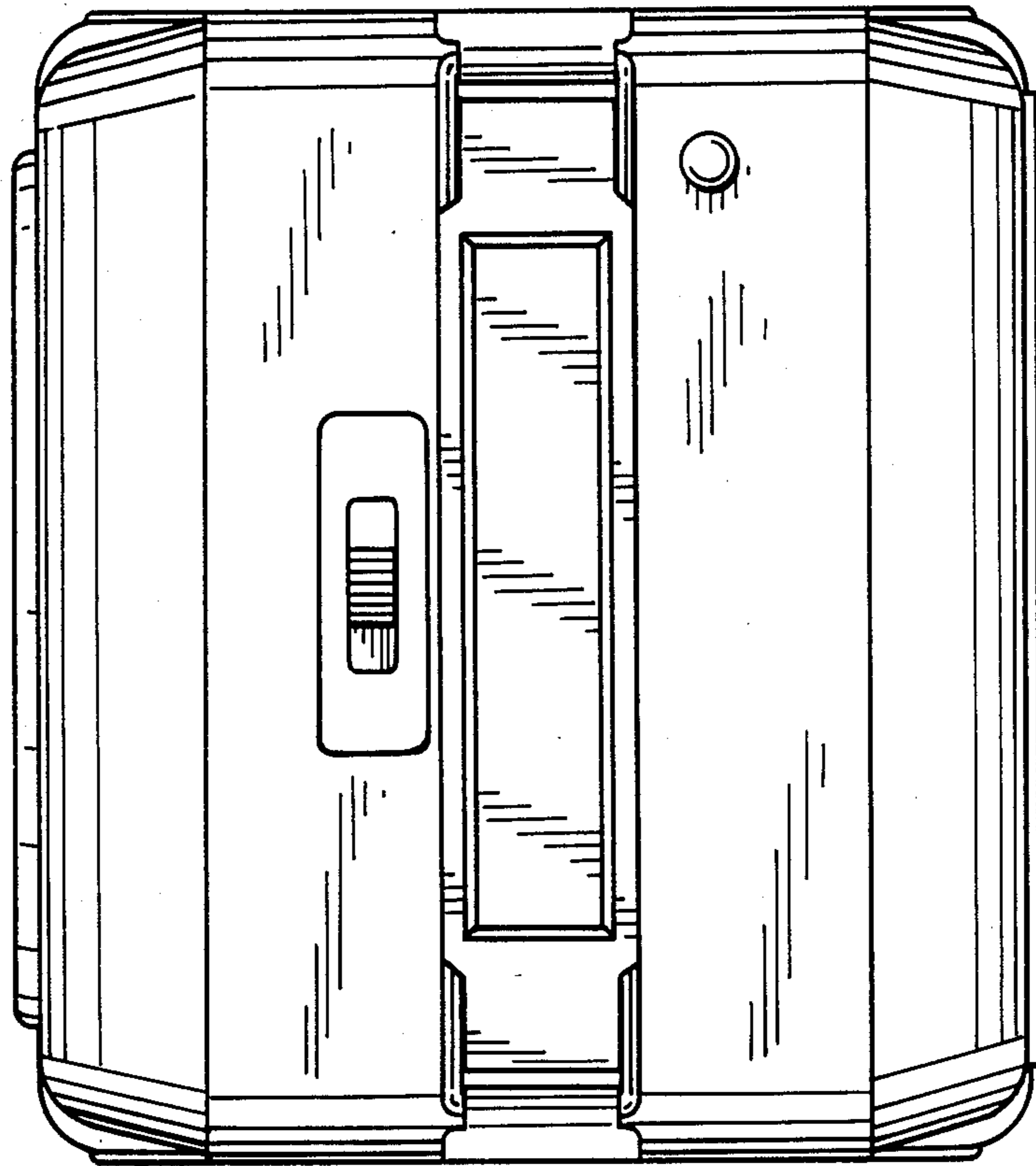

FIG. 5

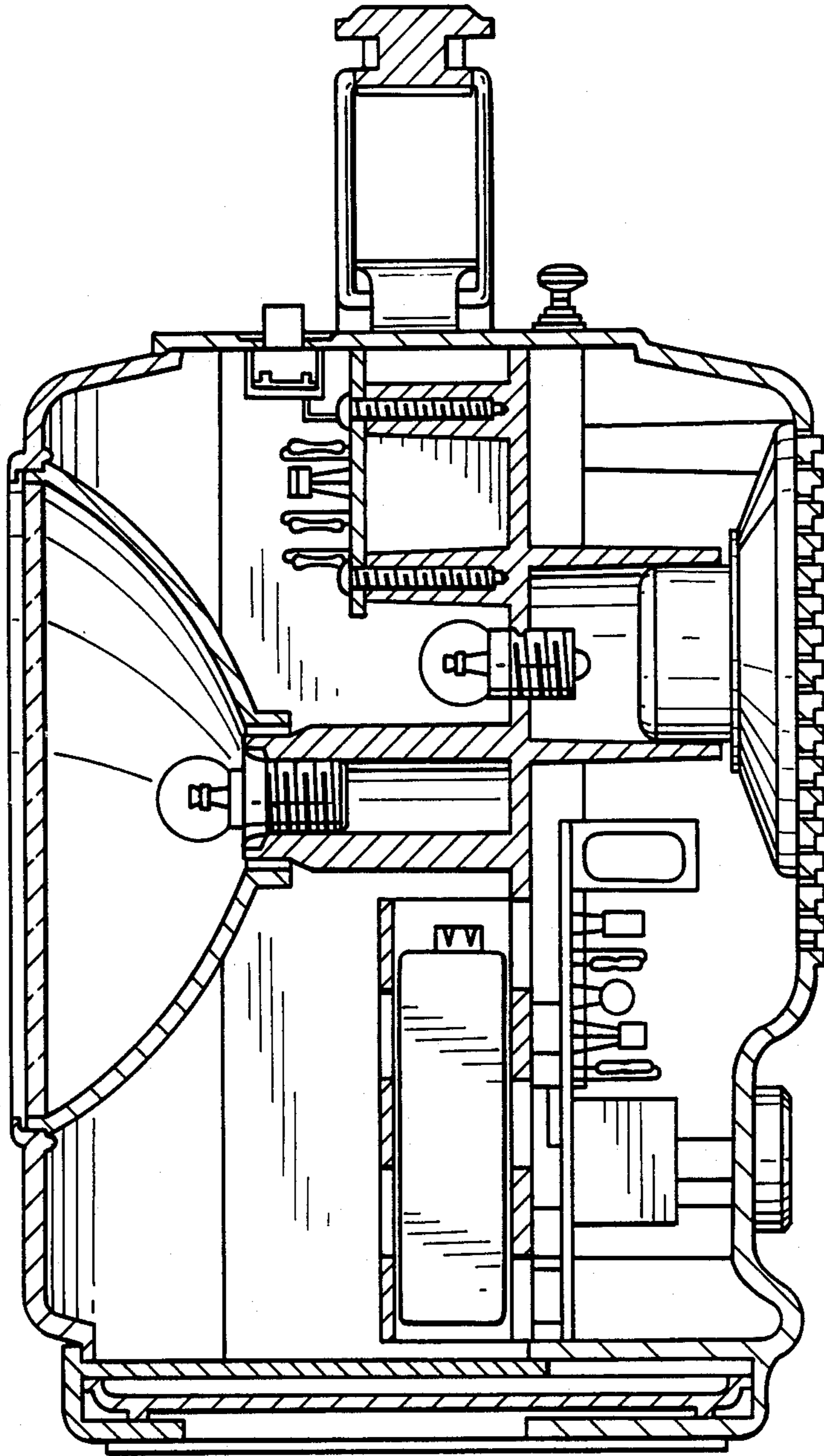
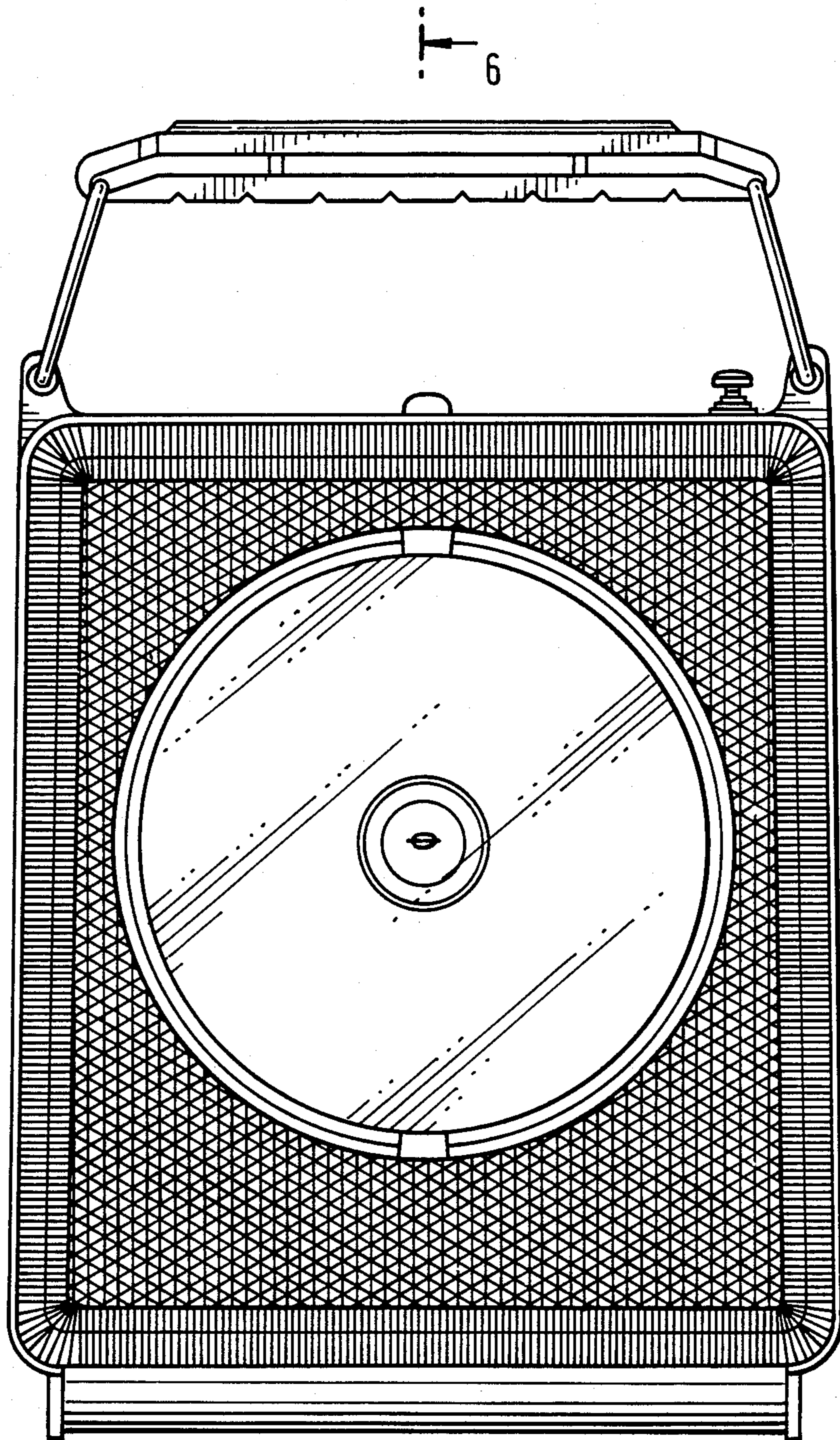

FIG. 6



6

FIG. 7