

[54] TELEPHONE CRAFTSMAN TEST SET

[76] Inventor: John R. Mason, 743 Shadow Lade Dr., Thousand Oaks, Calif. 91360

[**] Term: 14 Years

[21] Appl. No.: 104,312

[22] Filed: Oct. 5, 1987

[52] U.S. Cl. D14/138; D14/147; 379/434; 379/433

[58] Field of Search D14/52, 53, 62, 63, D14/64; 379/433, 440, 434, 419, 428; D21/111

[56] References Cited

U.S. PATENT DOCUMENTS

- D. 46,267 8/1914 Letter D14/64
- D. 199,146 9/1964 Reed D21/122 X
- D. 203,994 3/1966 Brondlein et al. D14/64

- D. 218,172 7/1970 Lawrence D14/63
- D. 221,005 6/1971 Garrett et al. D14/64
- D. 258,061 1/1981 Freeman D14/64
- D. 258,656 3/1981 Vaughan et al. D14/53 X
- D. 283,025 3/1986 Gaus D14/64 X
- D. 290,255 6/1987 Taveau D14/63
- D. 295,411 4/1988 Cho et al. D14/63 X

Primary Examiner—Horace B. Fay, Jr.

[57] CLAIM

The ornamental design for telephone craftsman test set, as shown.

DESCRIPTION

FIG. 1 is a right side and rear perspective view of a telephone craftsman test set showing my new design; FIG. 2 is a front elevational view thereof; FIG. 3 is a left side elevational view thereof; FIG. 4 is a rear elevational view thereof; and FIG. 5 is a left side elevational view thereof.

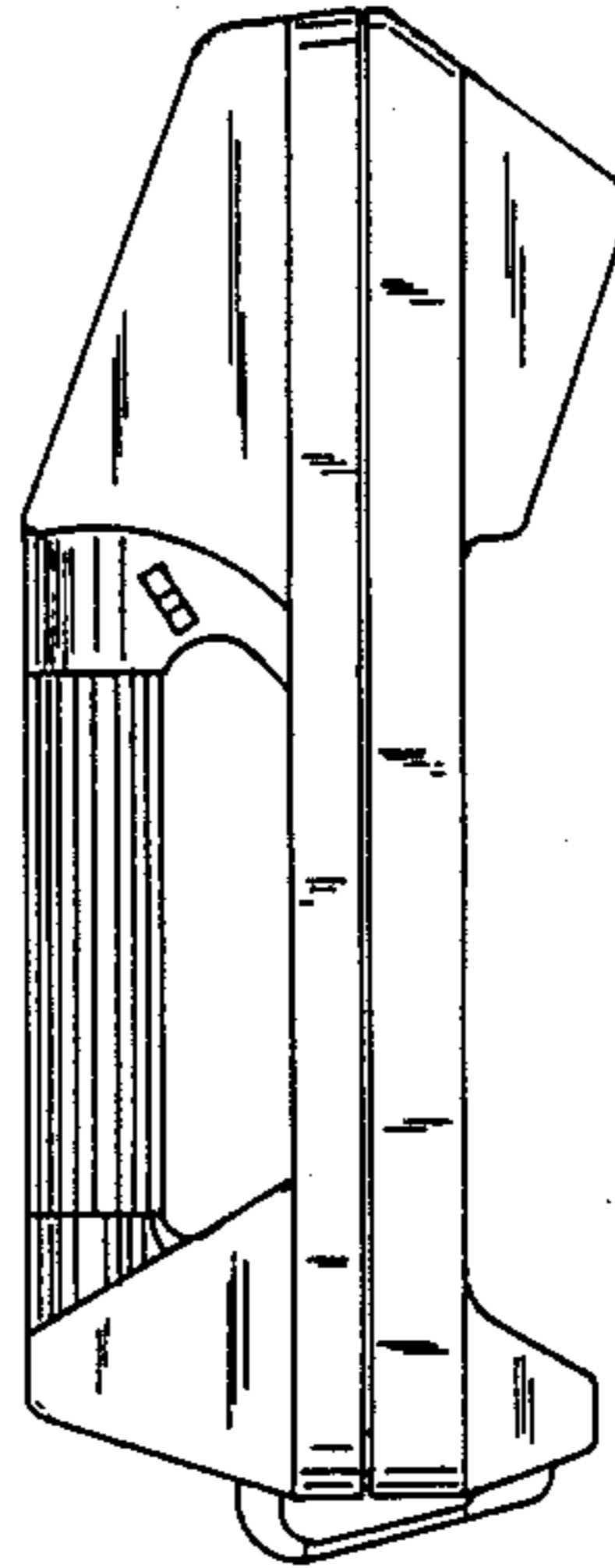
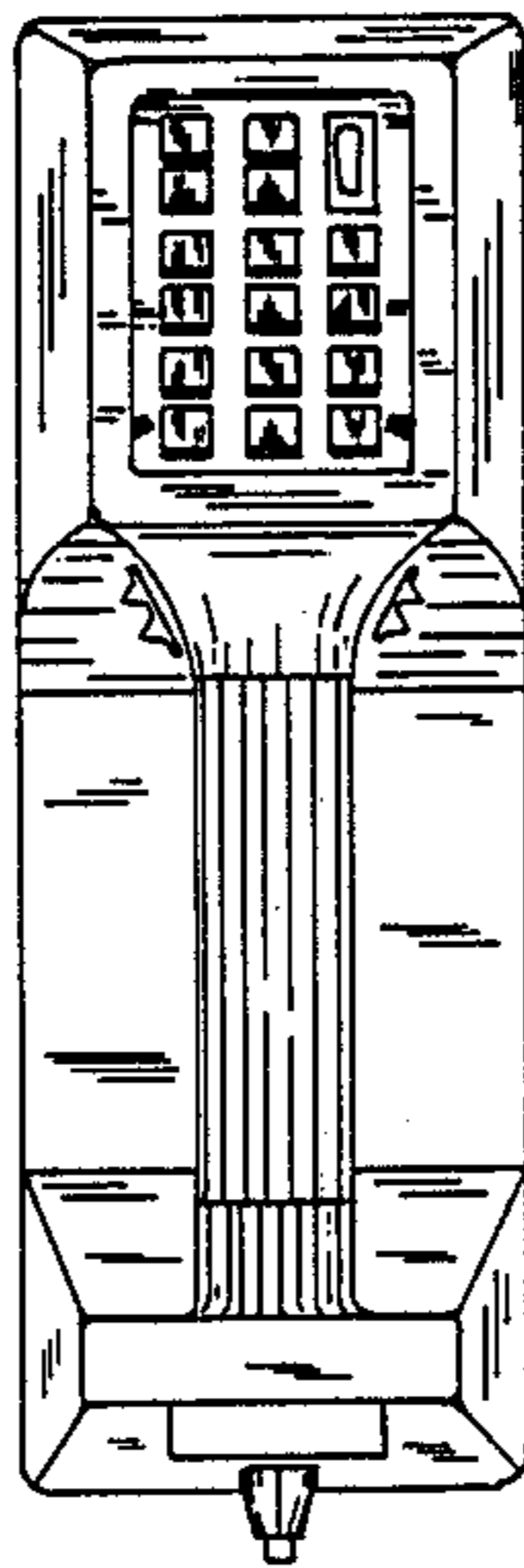

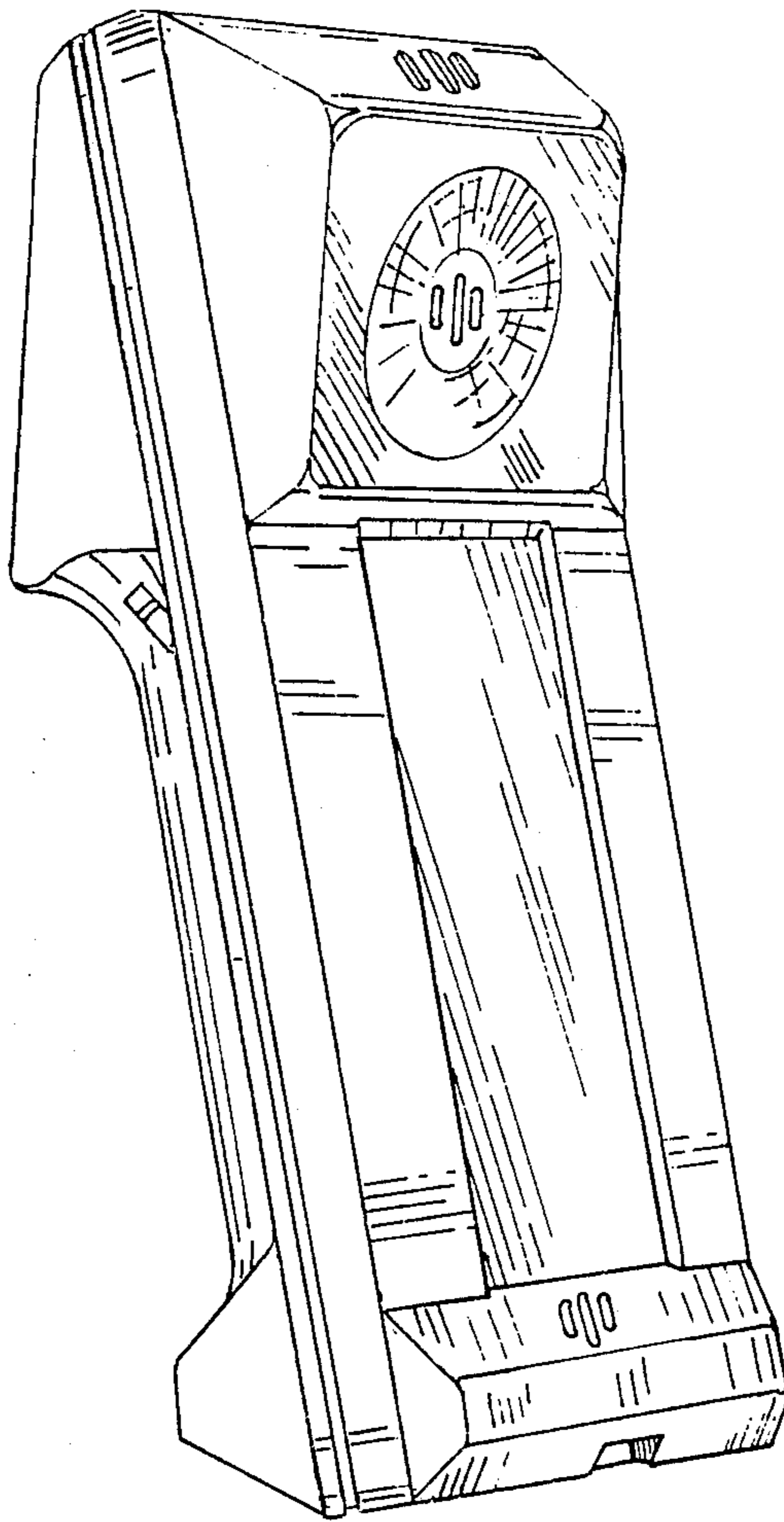

FIG. 1

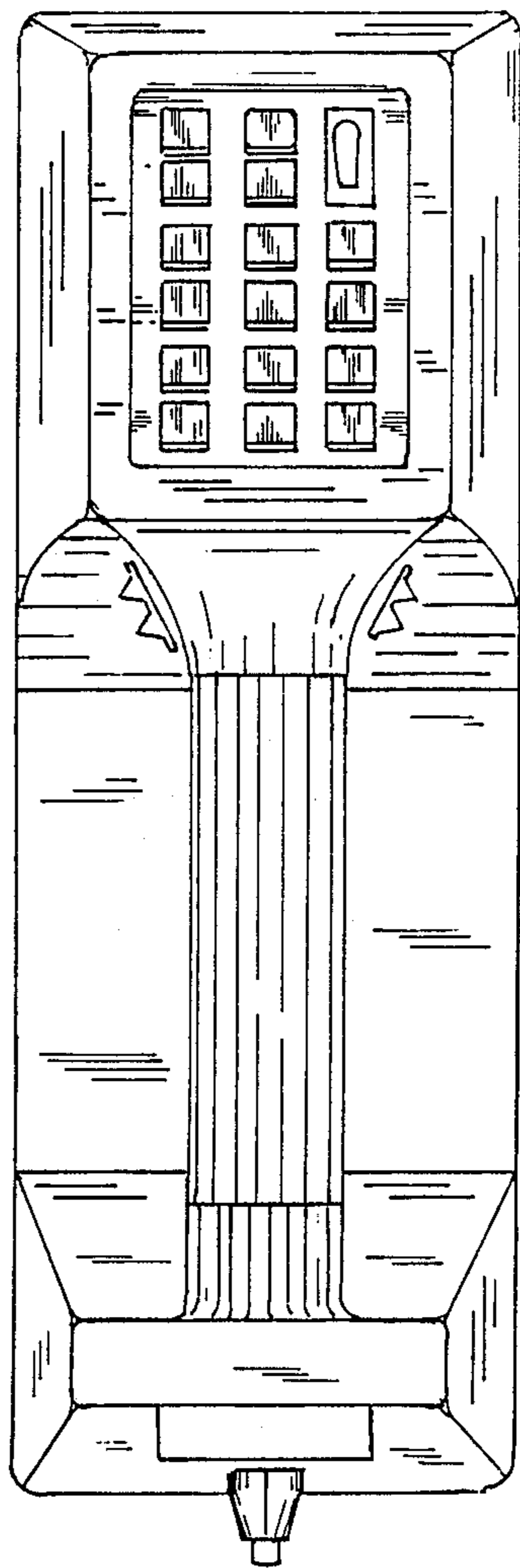

FIG. 2

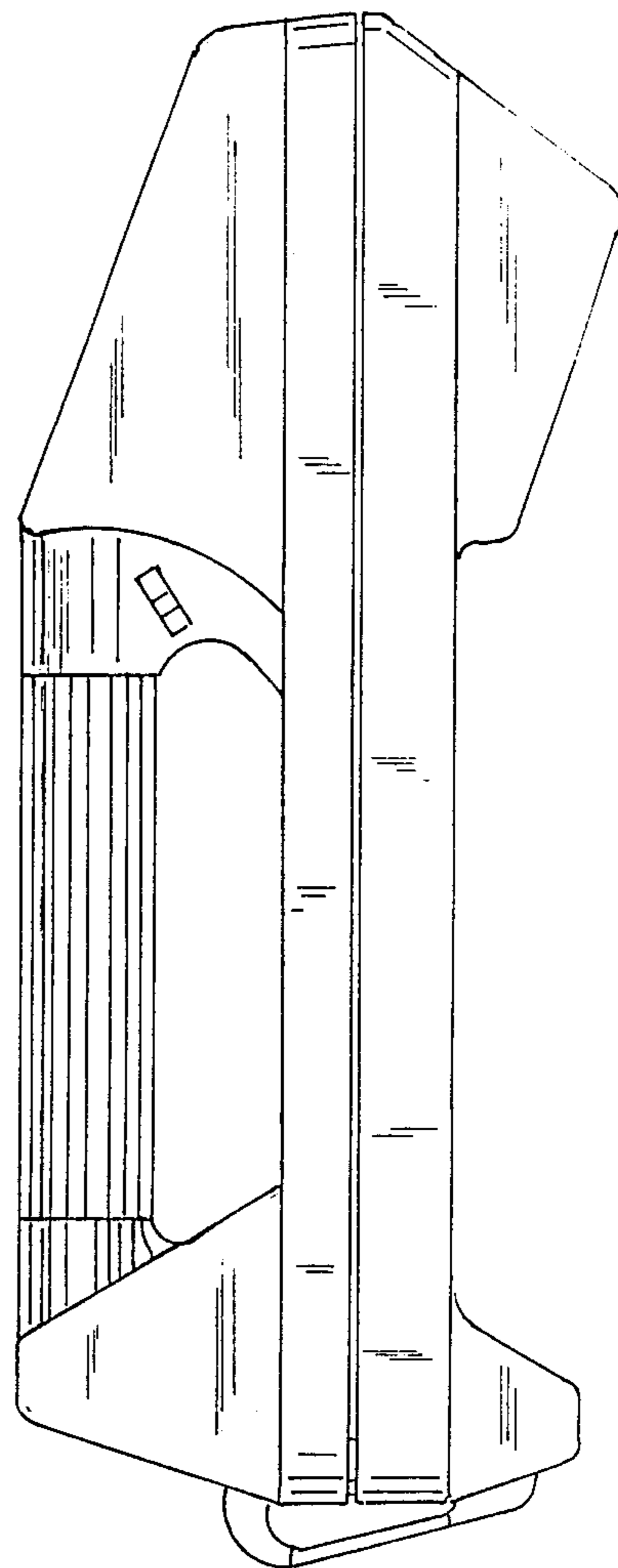

FIG. 3

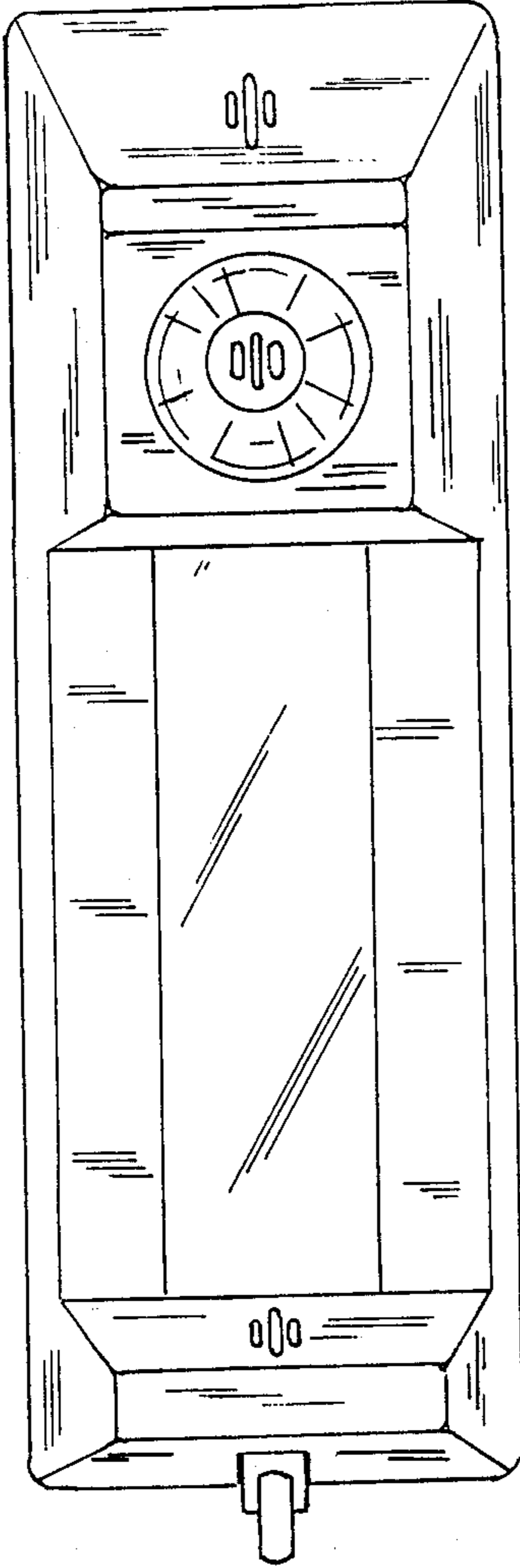

FIG. 4

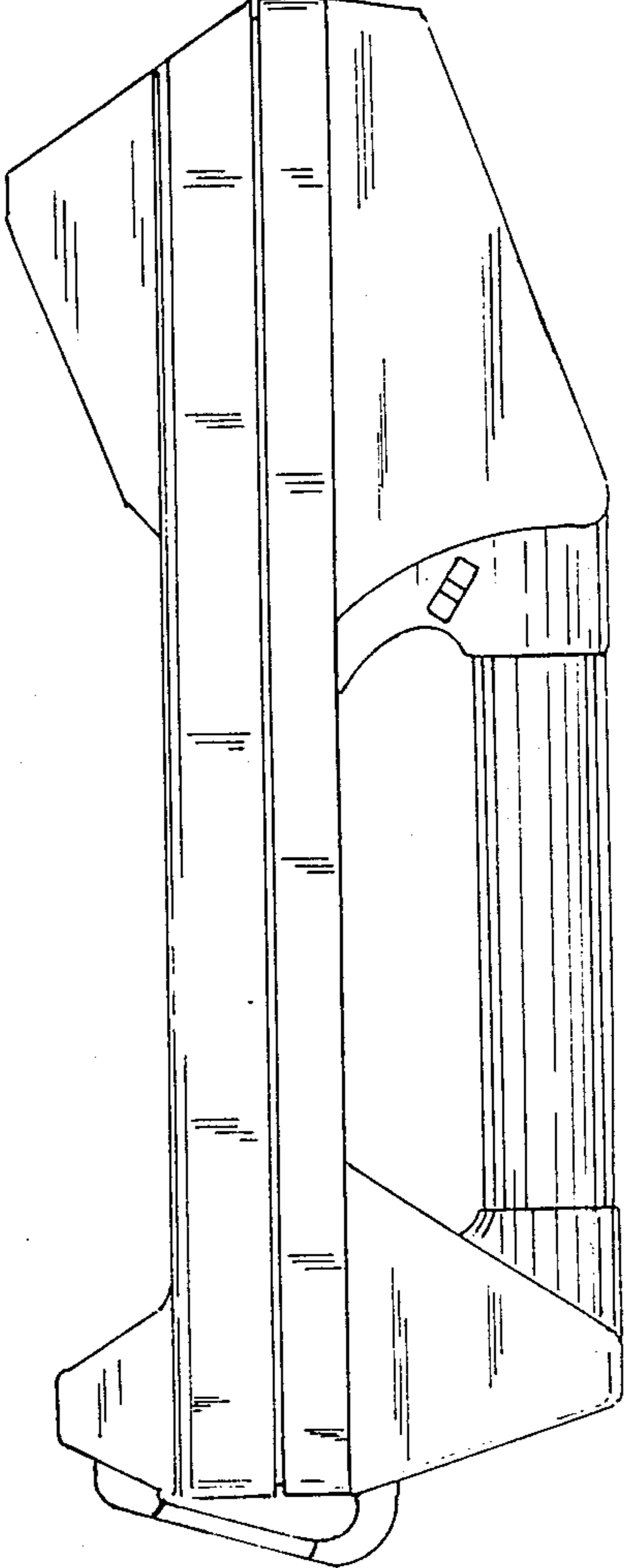

FIG. 5