

[54] MUG
[76] Inventor: **Paul Segal**, 15 Colonial Rd., White Plains, N.Y. 10605
[**] Term: **14 Years**
[21] Appl. No.: **934,316**
[22] Filed: **Nov. 24, 1986**
[52] U.S. Cl. **D7/9**
[58] Field of Search **D7/9, 6, 11, 13, 15, D7/319, 20, 10, 39; 220/94 R, 94 A**

[56] **References Cited**
U.S. PATENT DOCUMENTS
D. 258,795 4/1981 Zamorski D7/9
D. 290,571 6/1987 Rowe D7/9 X
1,975,241 10/1934 Werber et al. D7/9 X

OTHER PUBLICATIONS

New Compatibles by Pfaltzgraff, Supplement to HFD, Jan. 15, 1979, Sec. 2, Souper Mug 14 oz., p. 2.

Primary Examiner—Winifred E. Herrmann
Attorney, Agent, or Firm—Martin J. Spellman, Jr.

[57] **CLAIM**

The ornamental design for a mug, as shown.

DESCRIPTION

FIG. 1 is a top perspective view of a mug showing my new design;
FIG. 2 is a top plan view thereof;
FIG. 3 is a rear elevational view thereof;
FIG. 4 is a side elevational view thereof;
FIG. 5 is a front elevational view thereof; and
FIG. 6 is a bottom plan view thereof.

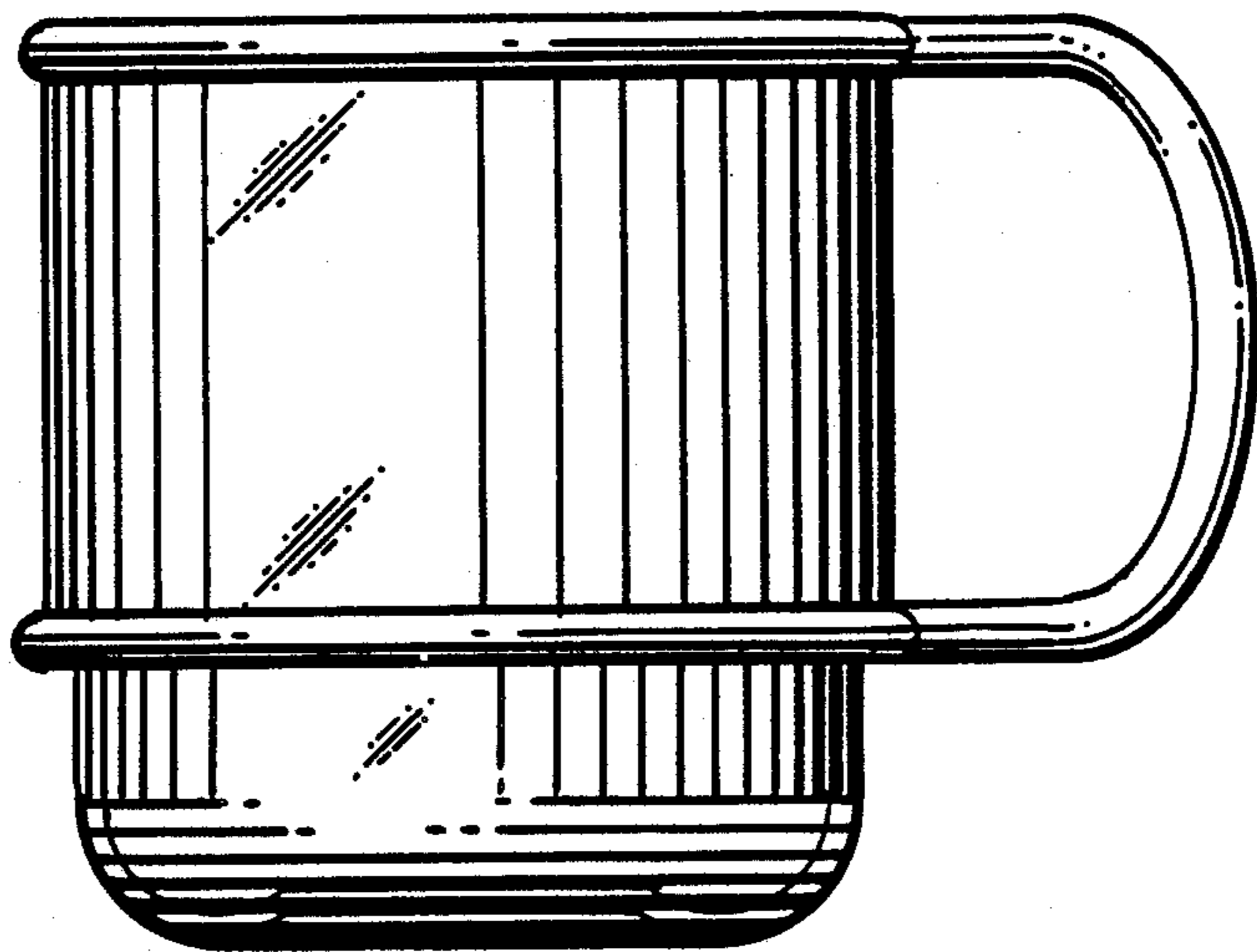
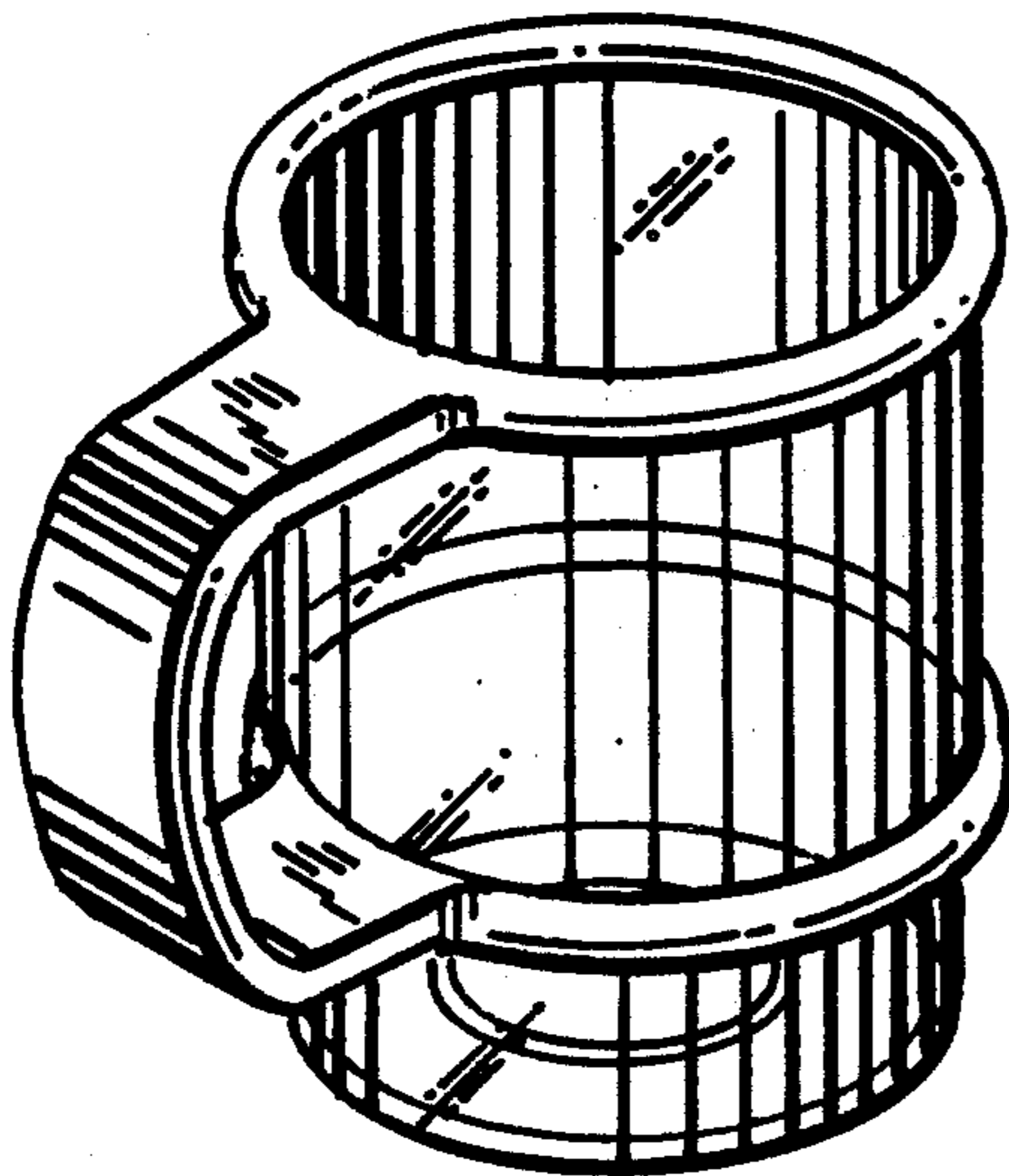

FIG.1

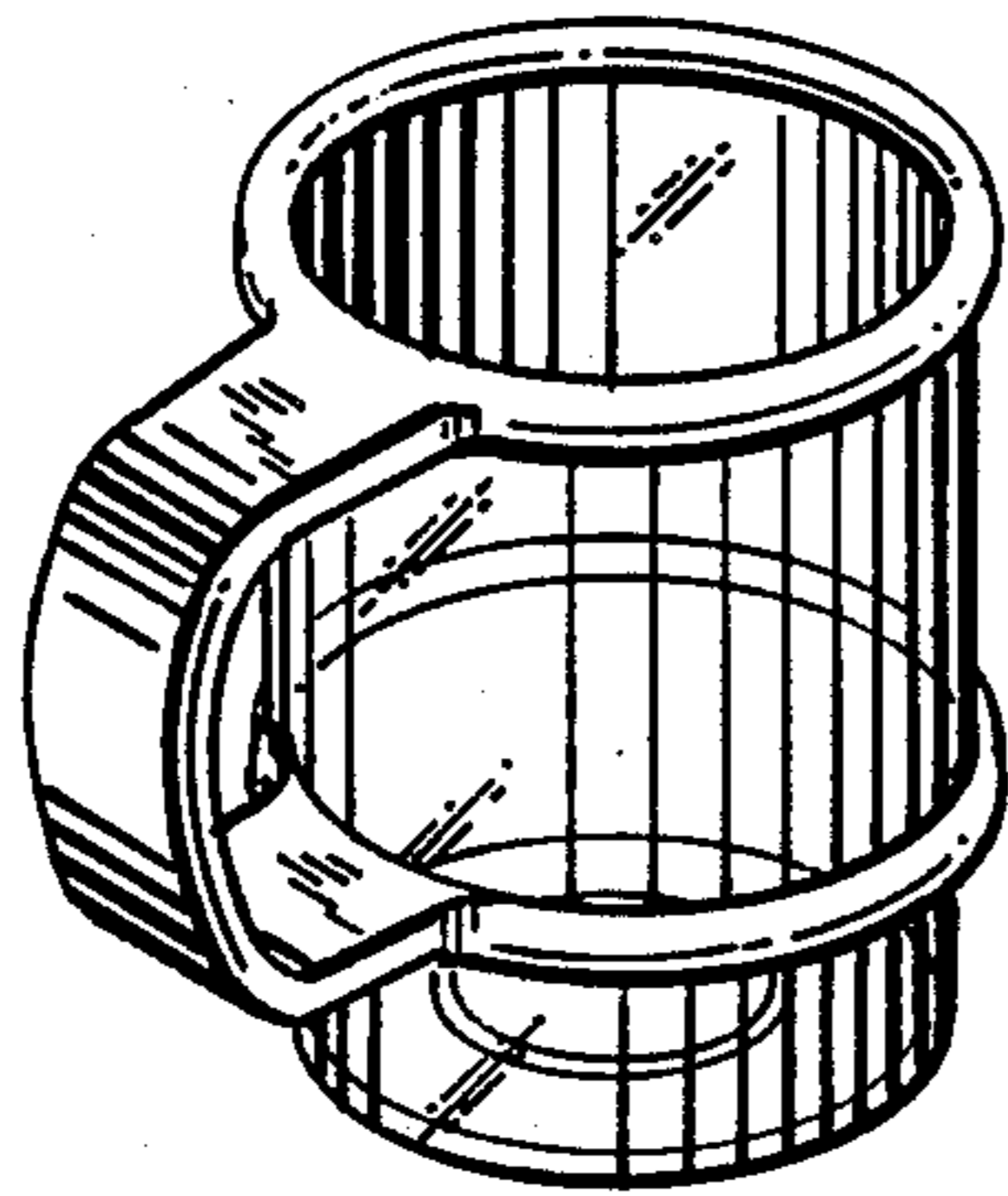

FIG.2

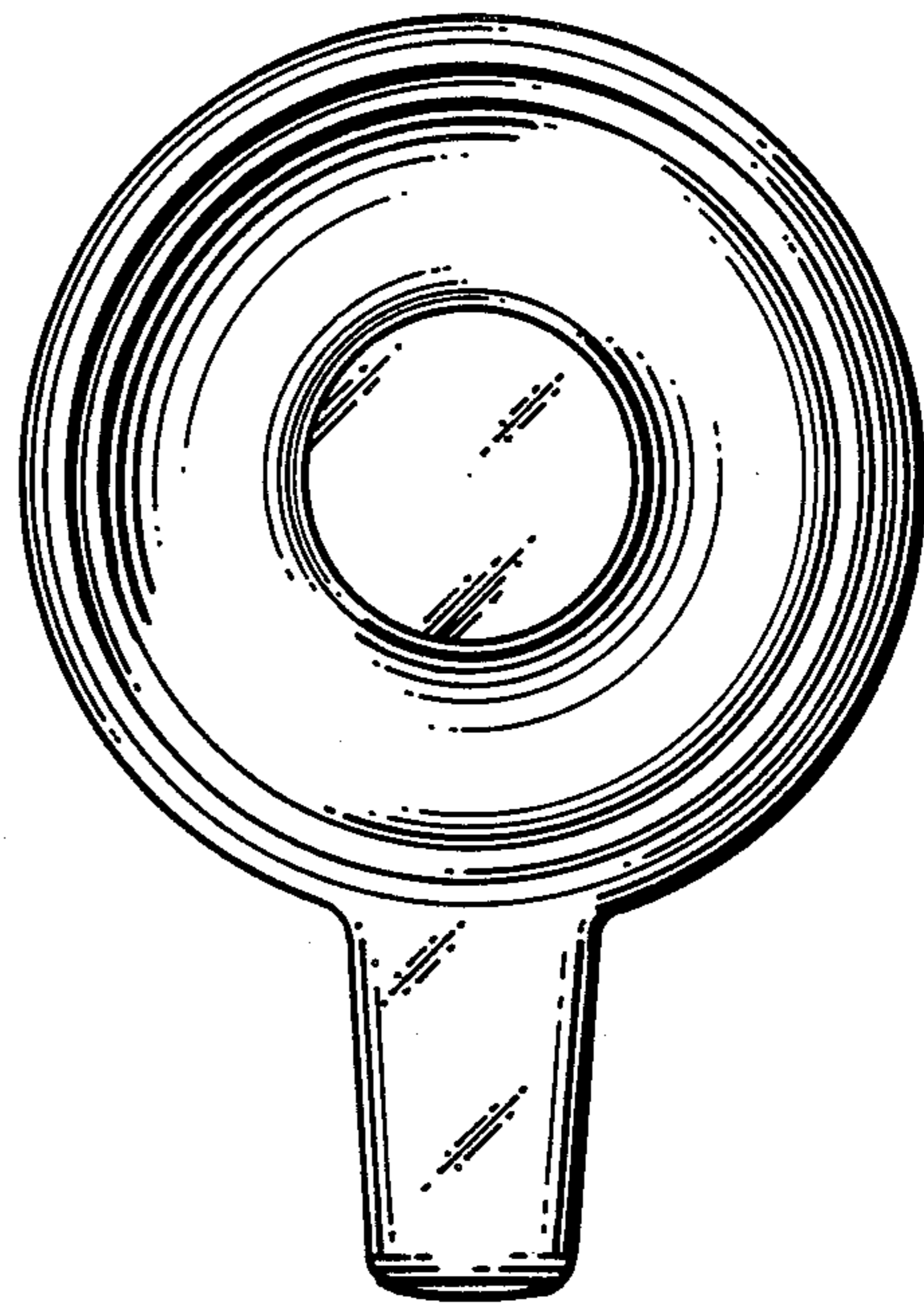

FIG.3

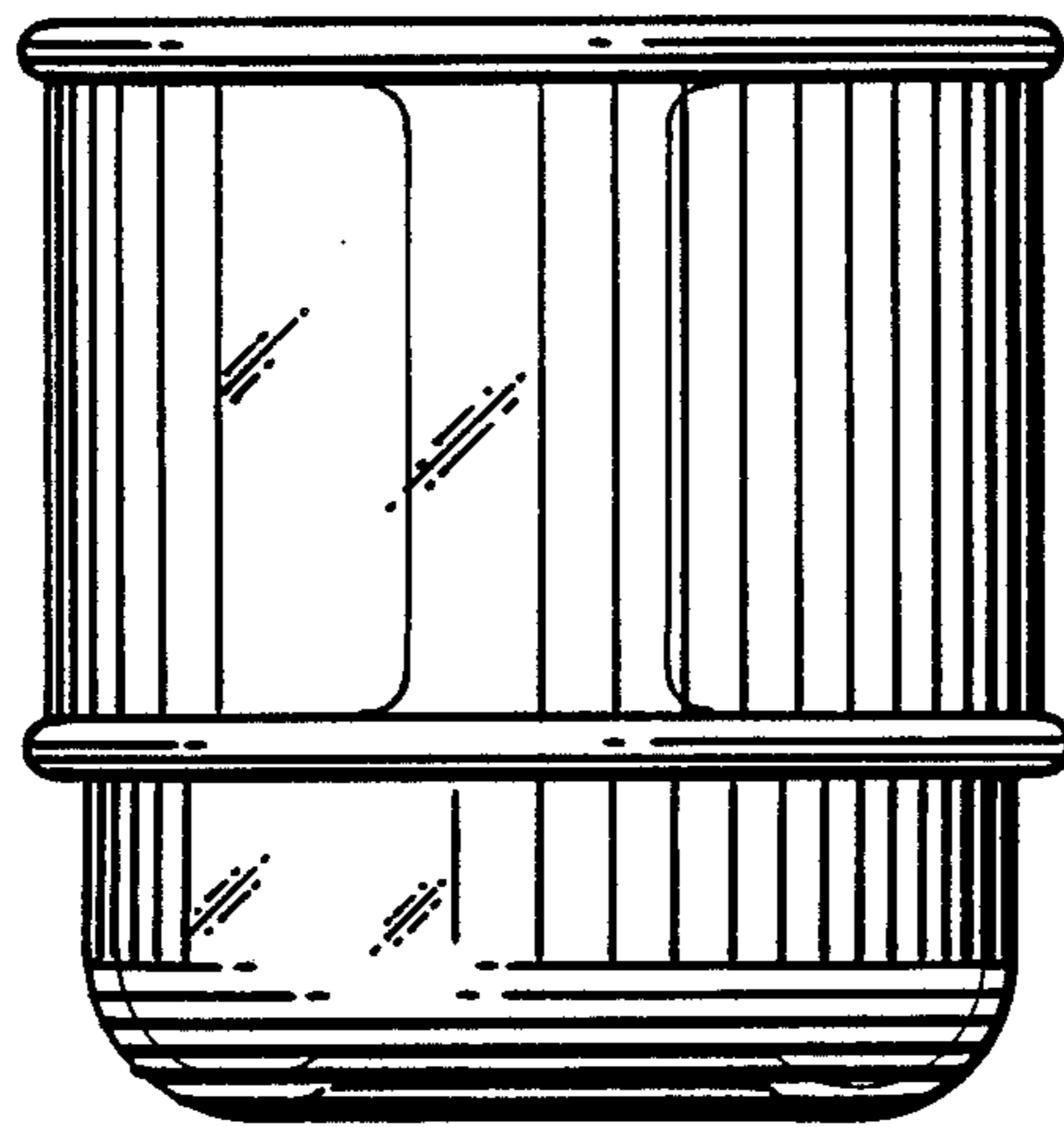

FIG.4

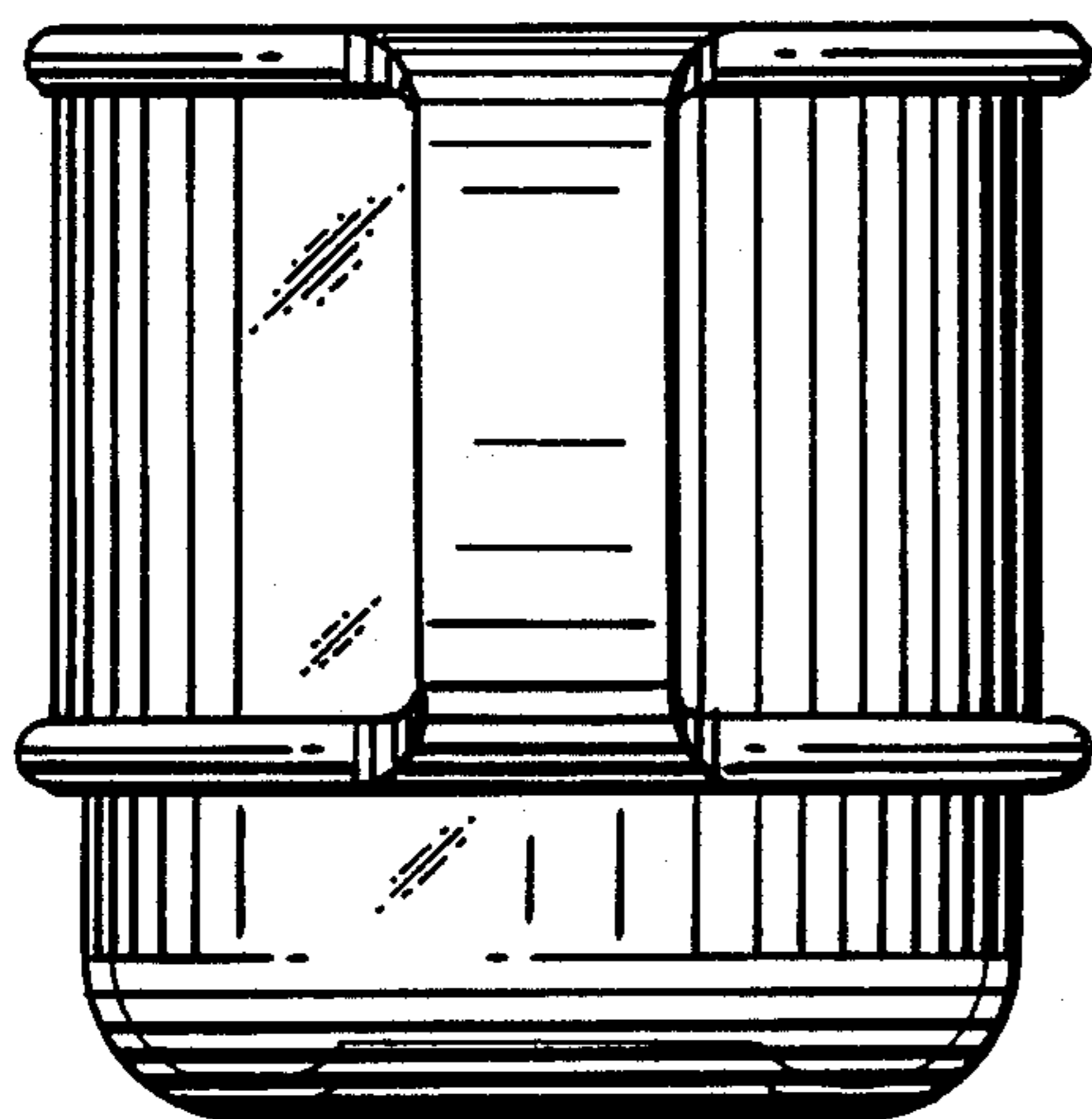
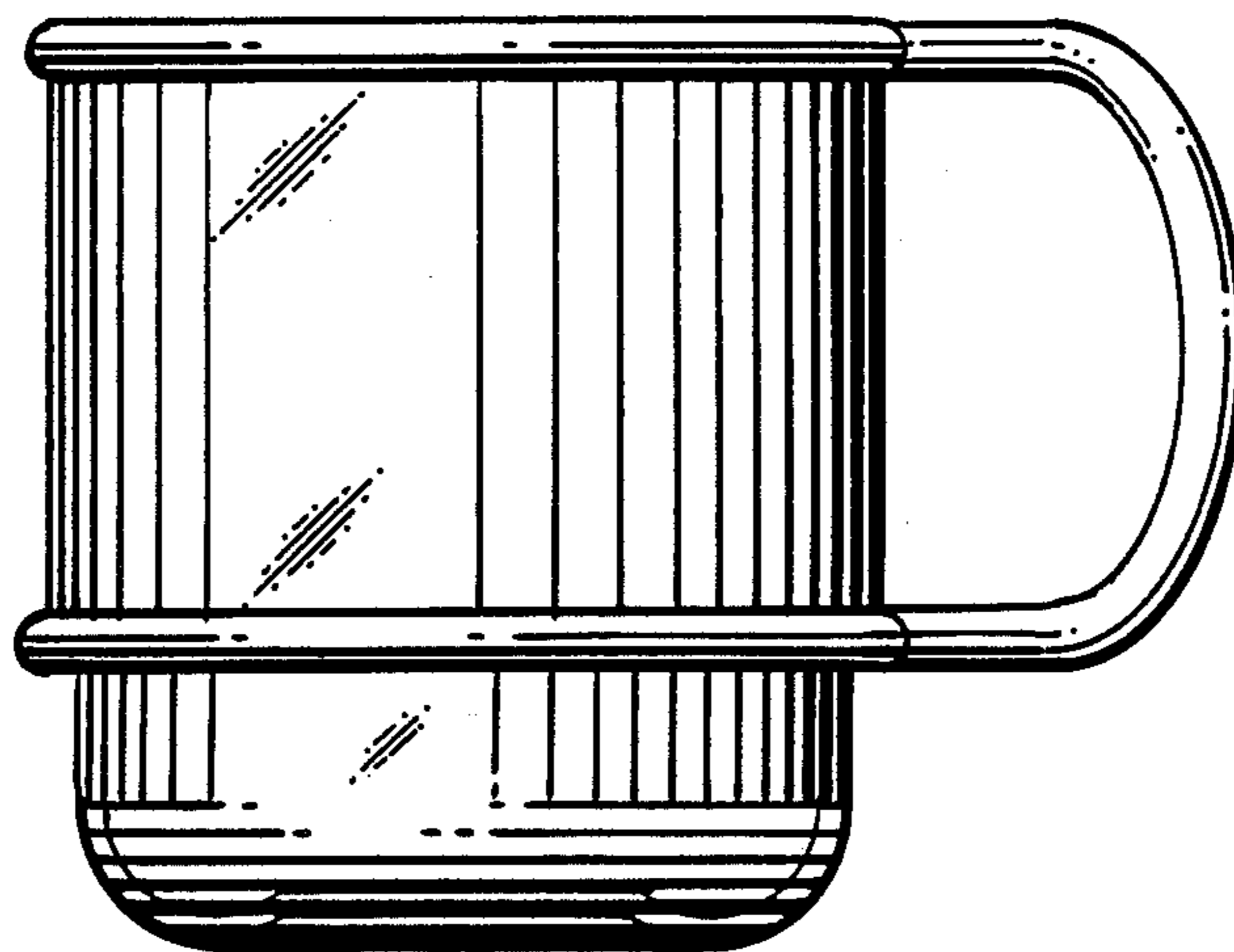

FIG.5

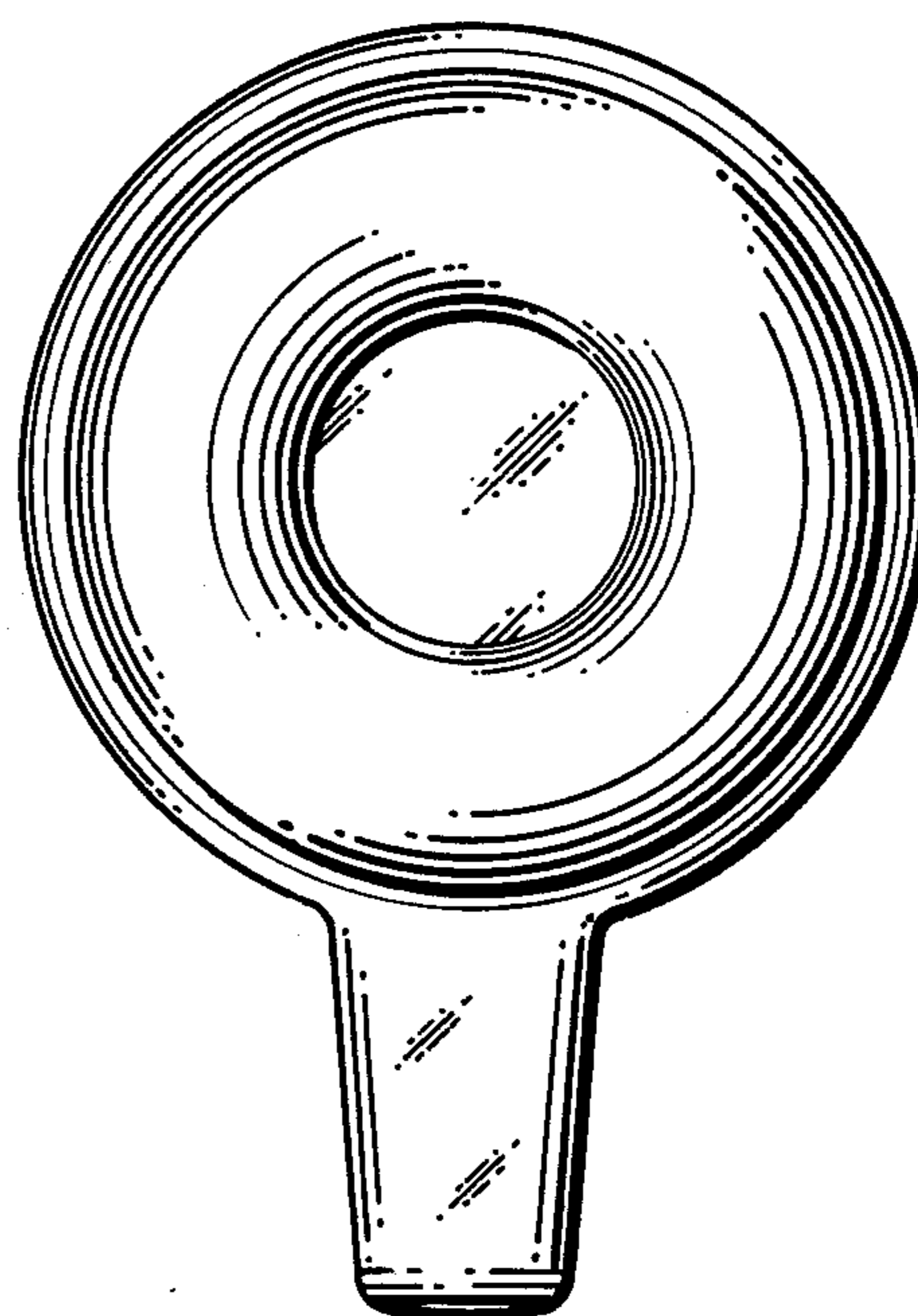

FIG.6