

[54] AUTOMOBILE LOCK SCRATCH GUARD

- [75] Inventor: Robert F. Marrinan, Worthington, Ohio
- [73] Assignee: The D.L. Auld Company, Columbus, Ohio
- [**] Term: 14 Years
- [21] Appl. No.: 942,589
- [22] Filed: Dec. 16, 1986
- [52] U.S. Cl. D8/350
- [58] Field of Search D8/350; 174/66; 220/241

[56] References Cited

U.S. PATENT DOCUMENTS

D. 176,282	12/1955	Patriquin .	
D. 179,436	12/1956	Arbib et al. .	
D. 179,659	2/1957	Schoepe .	
D. 185,005	4/1959	Kubota .	
D. 226,093	1/1973	Whiting et al.	D14/68
D. 228,061	8/1973	Kartarik .	
D. 238,584	1/1976	Goldman et al.	D26/14 K
D. 240,835	8/1976	Toth et al.	D26/14 K
D. 243,409	2/1977	Eckman et al.	D14/70
D. 268,182	3/1983	Asano et al.	D14/68
D. 271,764	12/1983	Toth et al.	D14/68
D. 272,737	2/1984	Coons et al.	D14/68
D. 273,864	5/1984	Eckmann	D14/68
D. 276,159	10/1984	Huntington	D14/72
D. 280,507	9/1985	Claxton et al.	D14/68
D. 280,620	9/1985	Toth et al.	D14/70
D. 282,437	2/1986	Marrinan et al. .	
D. 282,438	2/1986	Marrinan et al. .	
D. 282,660	2/1986	Imazeki	D14/68
D. 282,661	2/1986	Imazeki	D14/68
D. 290,957	7/1987	Imazeki	D14/68
2,733,474	2/1956	Capitani .	

OTHER PUBLICATIONS

- Customline Automotive brochure 1984; p. 4, Fuel Hatch Guard 6010.
- Customline Automotive brochure 1984; p. 3, Ford Lock Guard 8018.
- Arrow Lock Corporation Brochure, p. 14, circa. 1966.
- Rally Accessories Inc., 1954 Catalog.
- Customline automotive Products Inc. 1985 Catalog.
- Motorola, STX Series Brochure, Copyright 1986.

Primary Examiner—B. J. Bullock
 Attorney, Agent, or Firm—Killworth, Gottman, Hagan & Schaeff

[57] CLAIM

The ornamental design for an automobile lock scratch guard, as shown and described.

DESCRIPTION

FIG. 1 is a front view of an automobile lock scratch guard showing my new design;
 FIG. 2 is a top view thereof;
 FIG. 3 is a bottom view thereof;
 FIG. 4 is a front view of a second embodiment of the design of FIG. 1, this embodiment being a mirror image of FIG. 1;
 FIG. 5 is a left side view of FIG. 1;
 FIG. 6 is a right side view of FIG. 1;
 FIG. 7 is a front view of a third embodiment of the design of FIG. 1;
 FIG. 8 is a top view of FIG. 7;
 FIG. 9 is a bottom view of FIG. 7;
 FIG. 10 is a front view of a fourth embodiment of the design of FIG. 1, this embodiment being a mirror image of FIG. 7;
 FIG. 11 is a left side view of FIG. 7;
 FIG. 12 is a right side view of FIG. 7.
 The rear view of each of the embodiments being flat and unornamented.

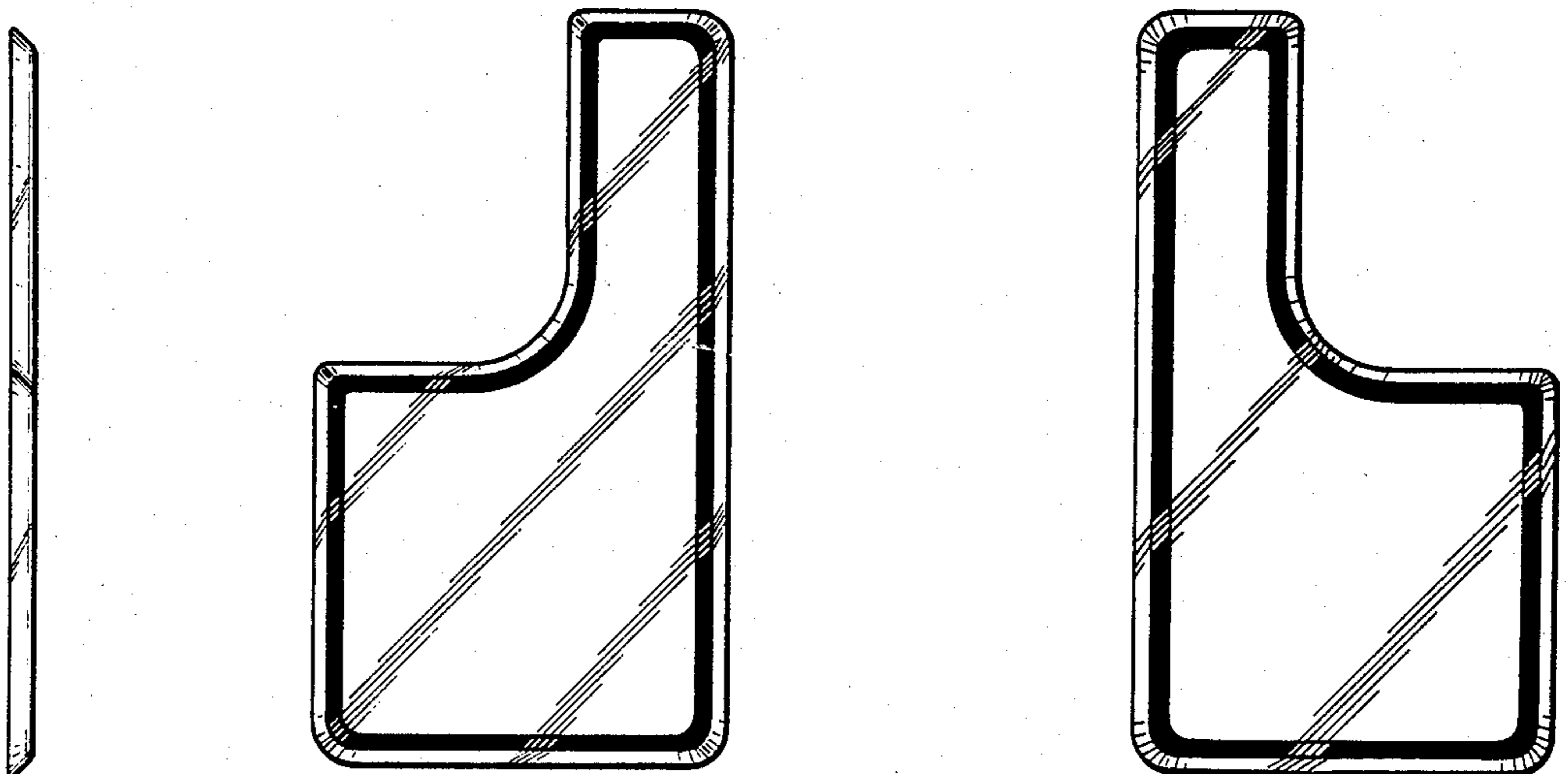

FIG-1

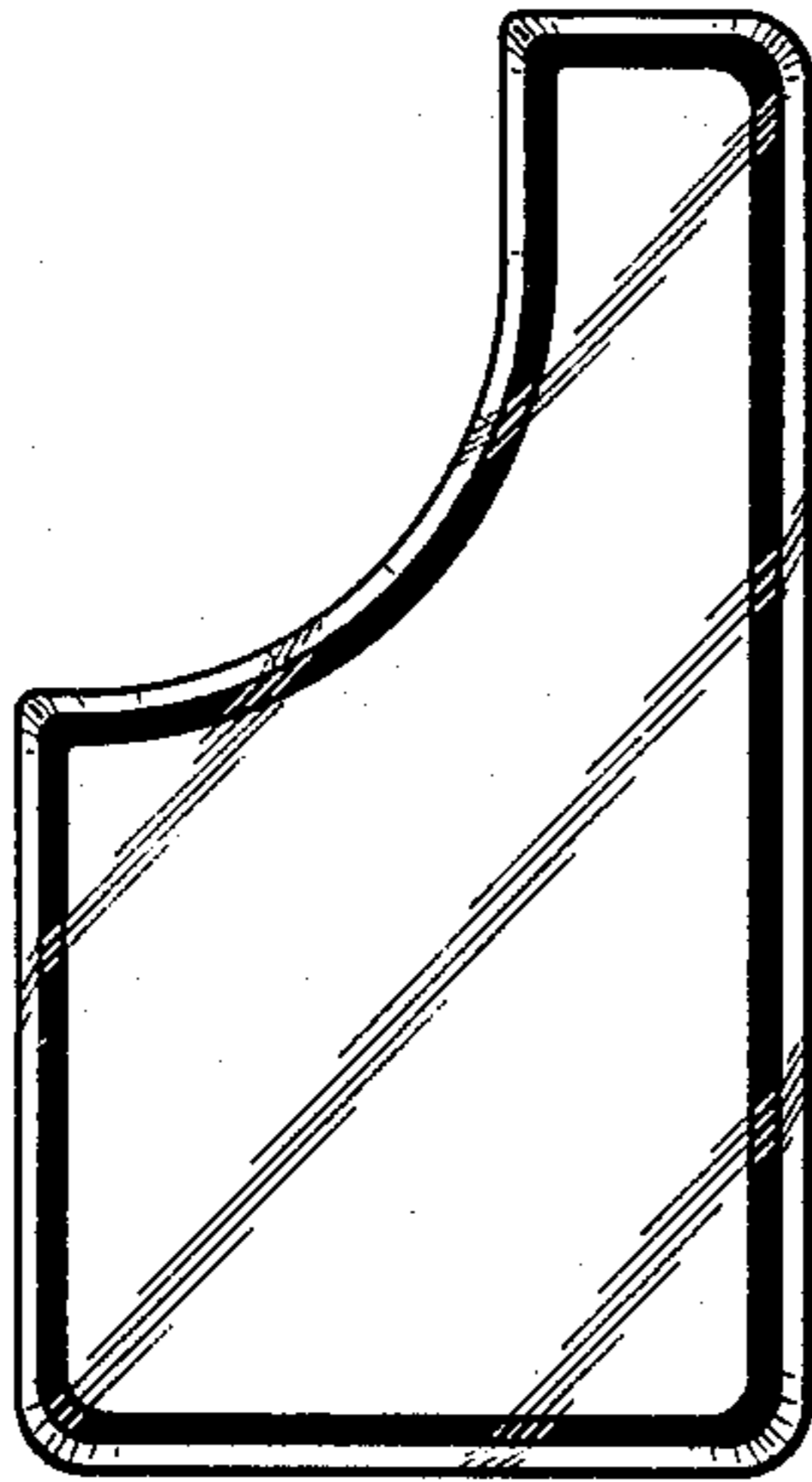

FIG-4

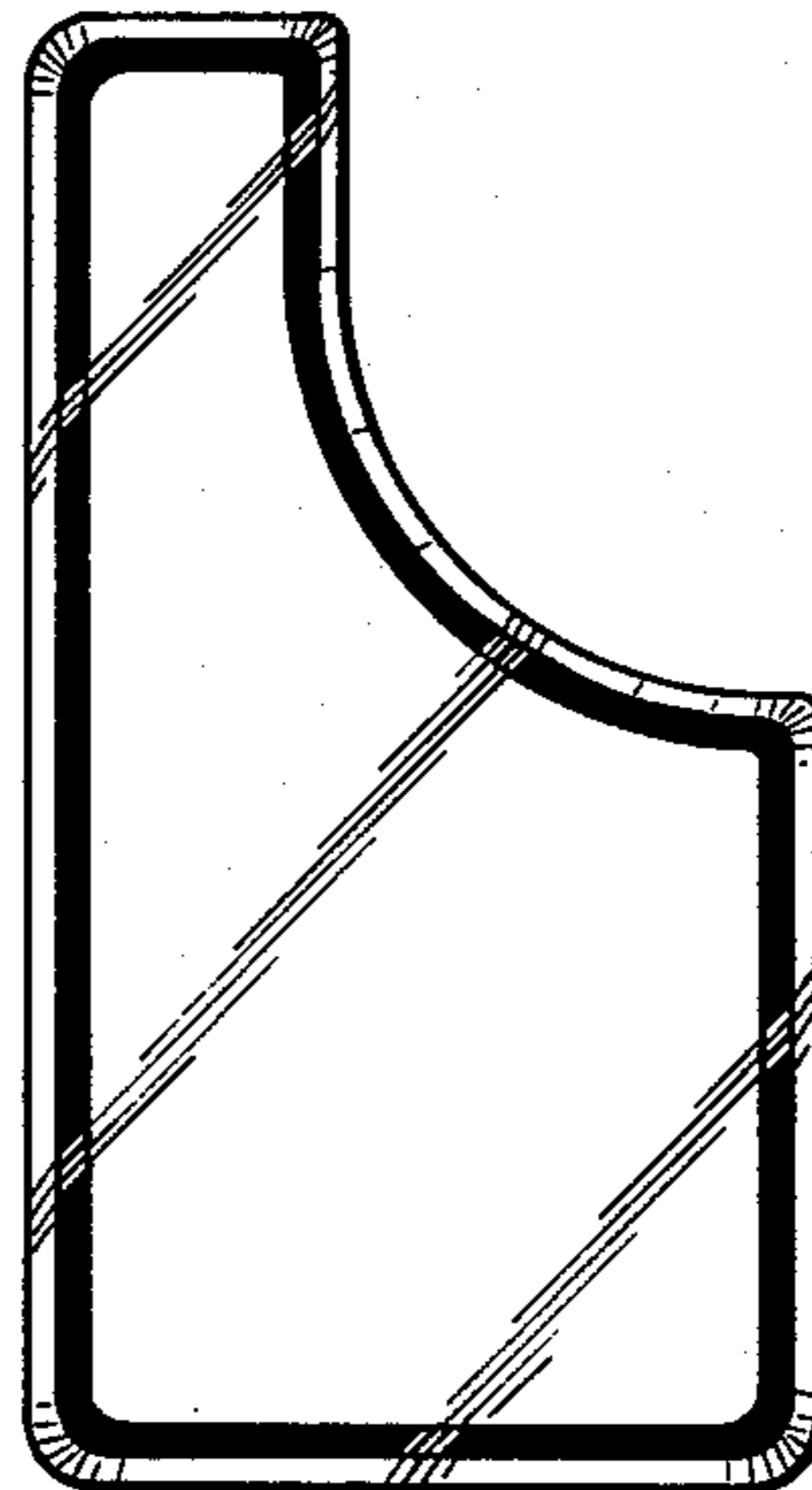

FIG-2

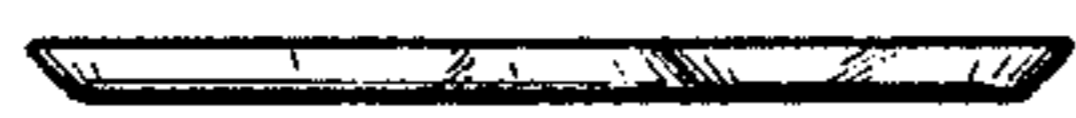

FIG-5



FIG-6



FIG-3

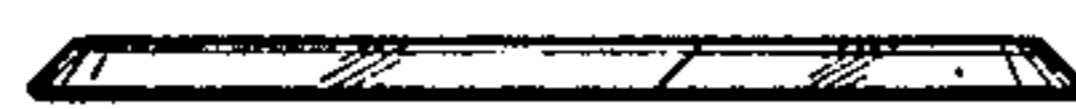

FIG-7

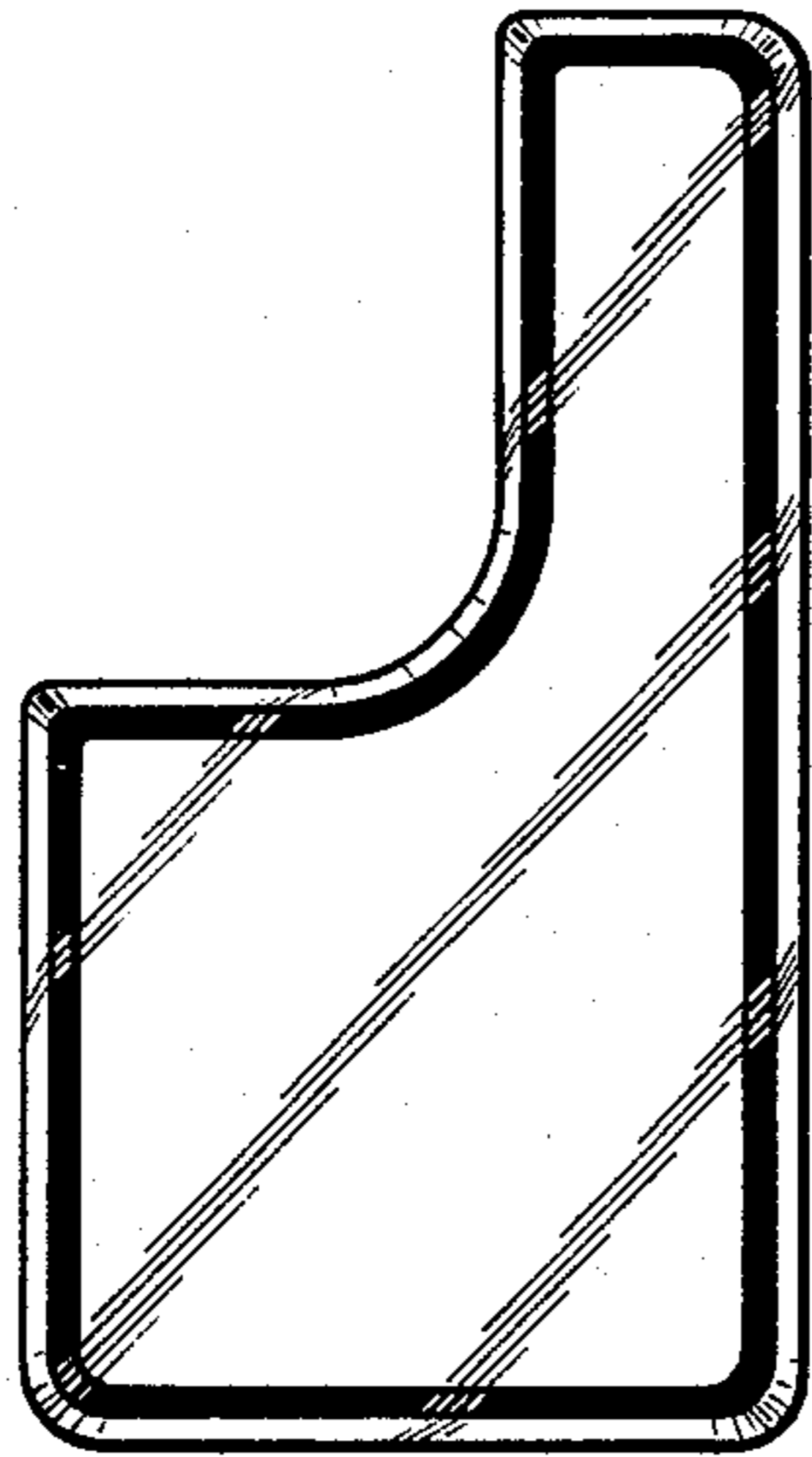

FIG-10

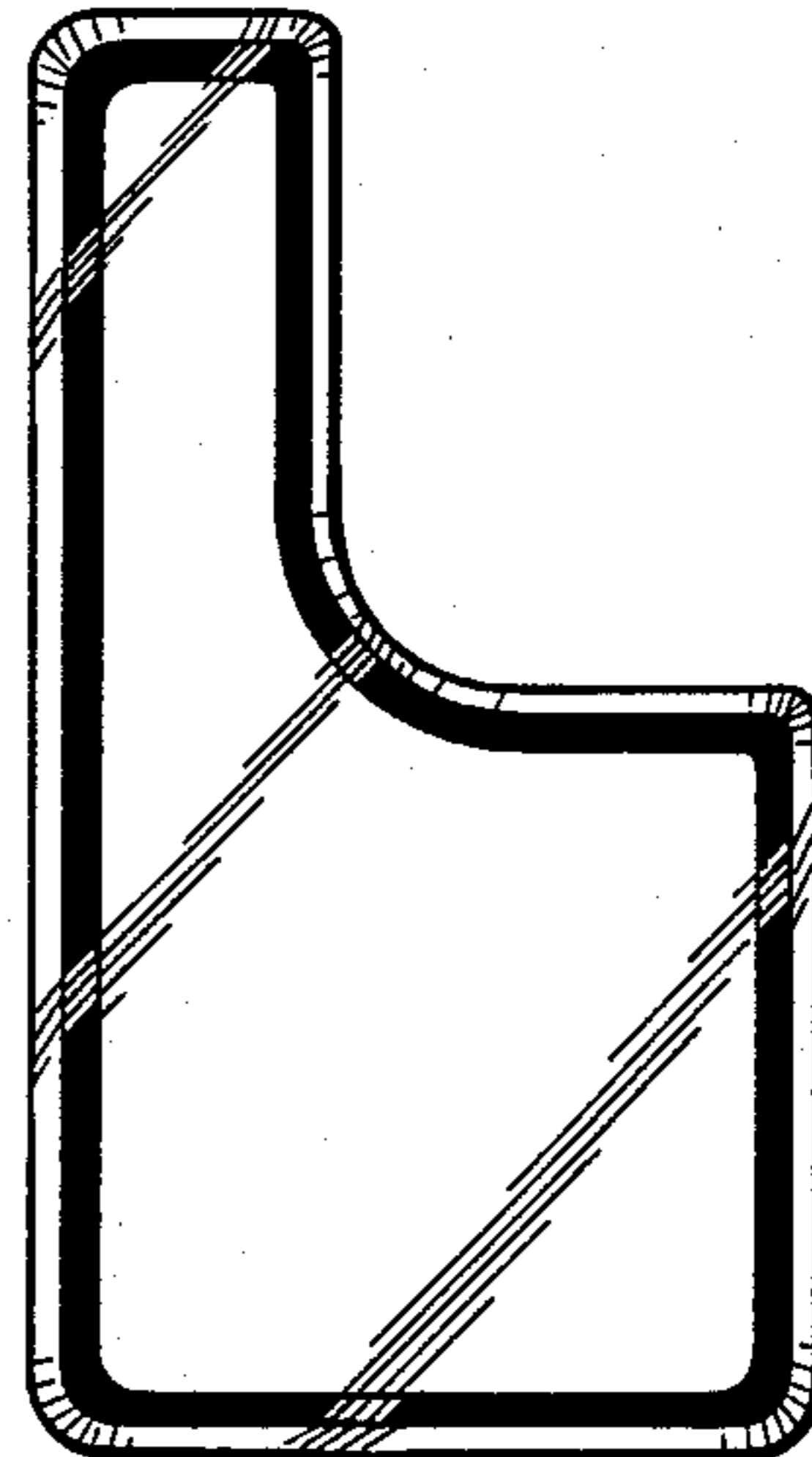

FIG-8



FIG-11



FIG-9



FIG-12

