

[54] SOD PLUGGER

[57] CLAIM

[75] Inventor: John W. Slayton, Jonesboro, Ark.

The ornamental design for a sod plugger, as shown and described.

[73] Assignee: Sun Coast, Inc., Jonesboro, Ark.

DESCRIPTION

[**] Term: 14 Years

FIG. 1 is a front elevational view of a sod plugger showing my new design, the rear being a mirror image of that shown;

[21] Appl. No.: 34,571

FIG. 2 is a horizontal cross-sectional view thereof, taken along line 2—2 of FIG. 1;

[22] Filed: Apr. 6, 1987

FIG. 3 is a right side elevational view thereof, the left side being substantially similar in appearance;

[52] U.S. Cl. D8/7; D8/1

FIG. 4 is an enlarged top plan view thereof;

[58] Field of Search D8/1, 7, 9; 47/1 R; 172/19-22; 294/49; 273/162.5; 111/2, 4

FIG. 5 is an enlarged bottom plan view thereof; FIG. 6 is an enlarged vertical cross-sectional view thereof, taken along line 6—6 of FIG. 4, with the shaft portion being shown broken-away for ease of illustration;

[56] References Cited

U.S. PATENT DOCUMENTS

- D. 211,747 7/1968 Odell D8/7
- D. 213,058 12/1968 Clifton D8/10
- D. 222,658 11/1971 Carlson D8/7
- D. 235,504 6/1975 Kramer D8/7
- D. 251,698 5/1979 Bartholomew, Jr. D8/7
- 1,882,288 10/1932 Lee 7/116
- 3,771,794 11/1973 Crockett 172/378 X
- 4,209,903 7/1980 Owens 294/50.7

FIG. 7 is a front elevational view of an alternate embodiment thereof, the rear being a mirror image of that shown;

FIG. 8 is a horizontal cross-sectional view of the embodiment of FIG. 7;

FIG. 9 is a right side elevational view of the embodiment of FIG. 7 the left side being a mirror image of that shown;

FOREIGN PATENT DOCUMENTS

- 309727 4/1929 United Kingdom D8/7

FIG. 10 is an enlarged top plan view of the embodiment of FIG. 7;

FIG. 11 is an enlarged bottom plan view of the embodiment of FIG. 7; and

FIG. 12 is an enlarged vertical cross-sectional view of the embodiment of FIG. 7, taken along line 12—12 of FIG. 10, with the shaft portion being shown broken-away for ease of illustration.

Primary Examiner—Wallace R. Burke
Assistant Examiner—Brian N. Vinson
Attorney, Agent, or Firm—Walker & McKenzie

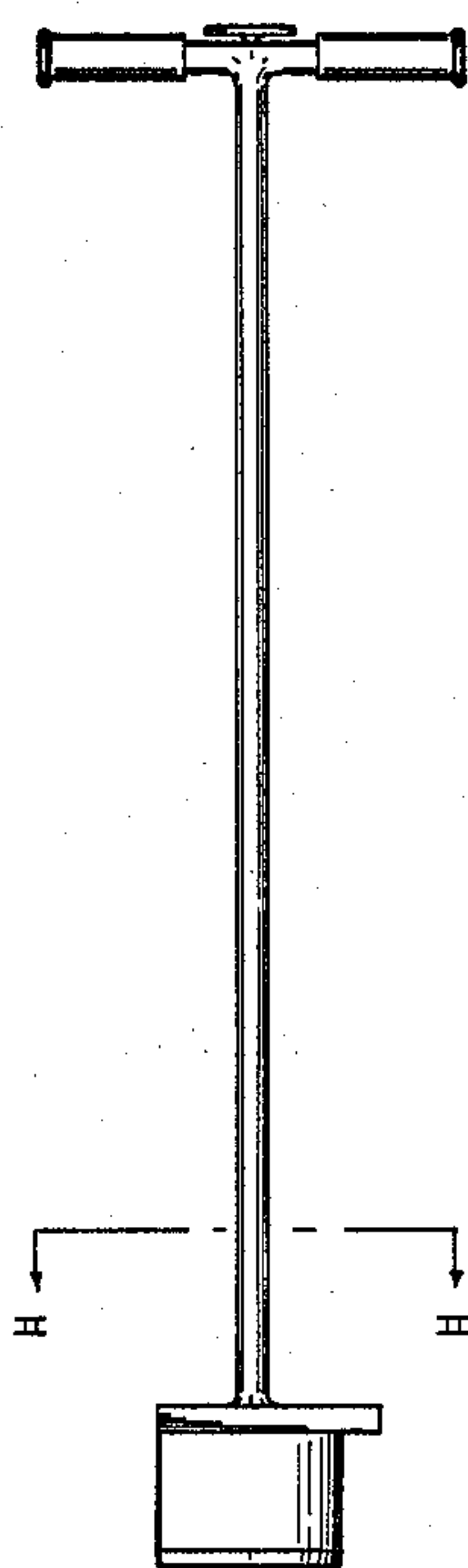

FIG. 1

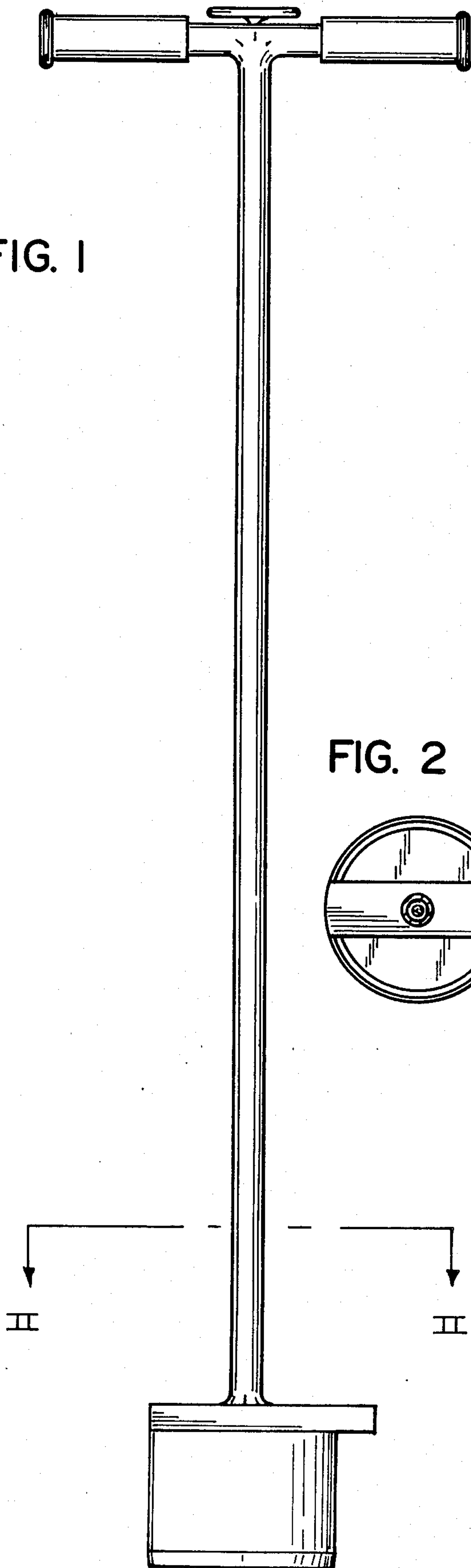

FIG. 3

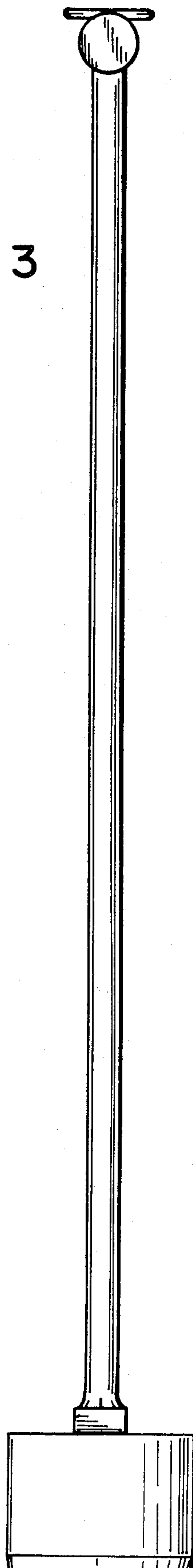

FIG. 2

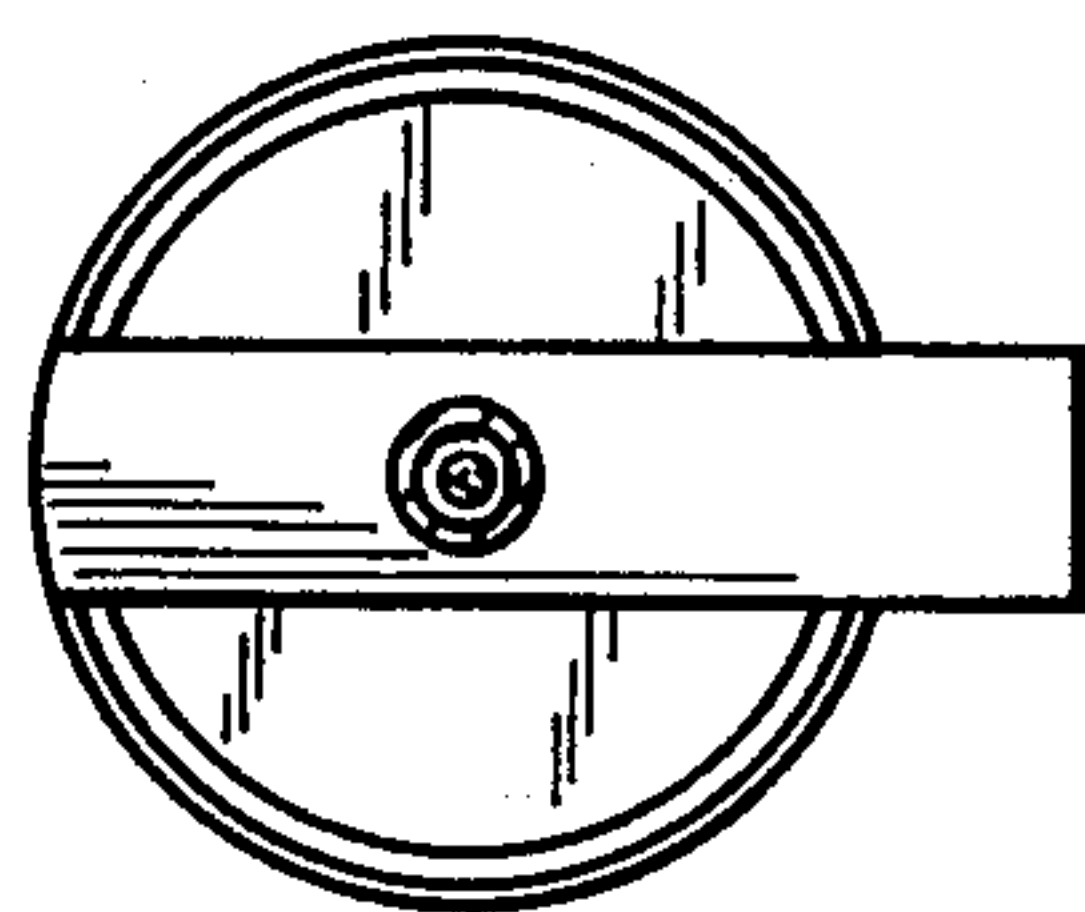

FIG. 4

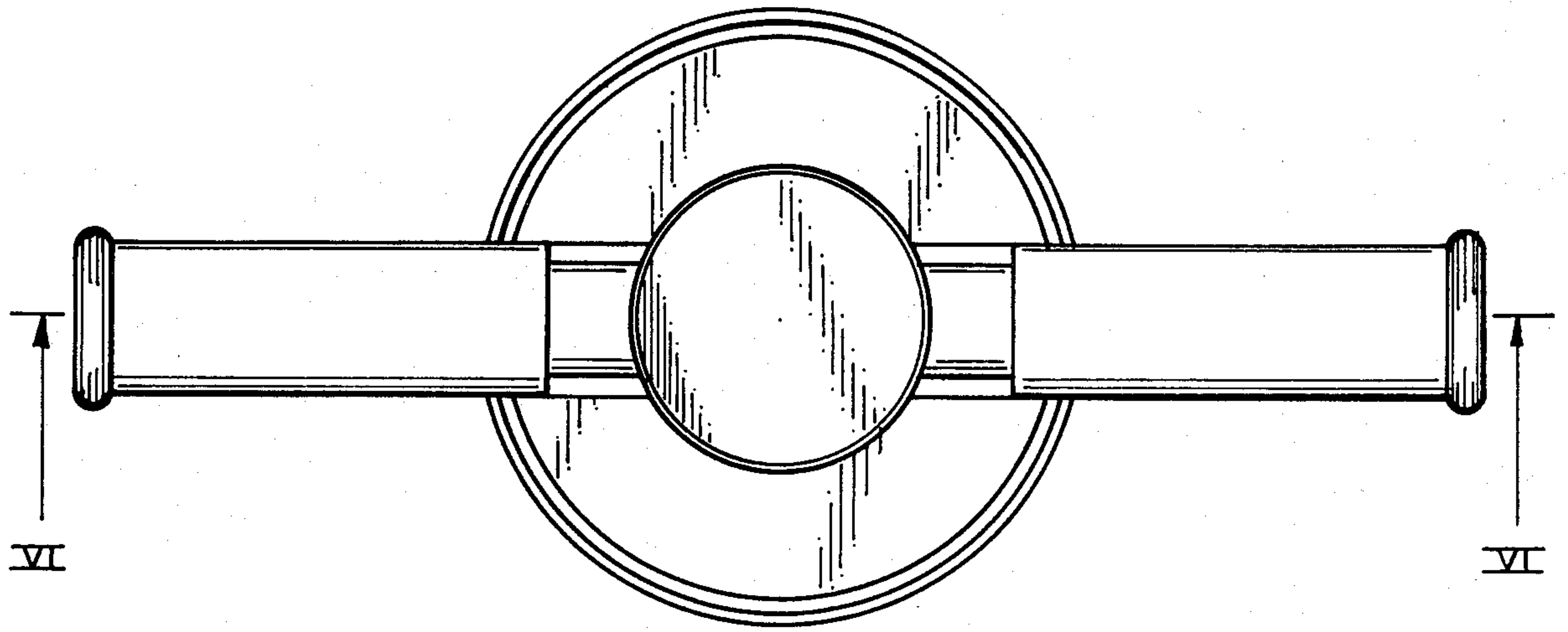

FIG. 5

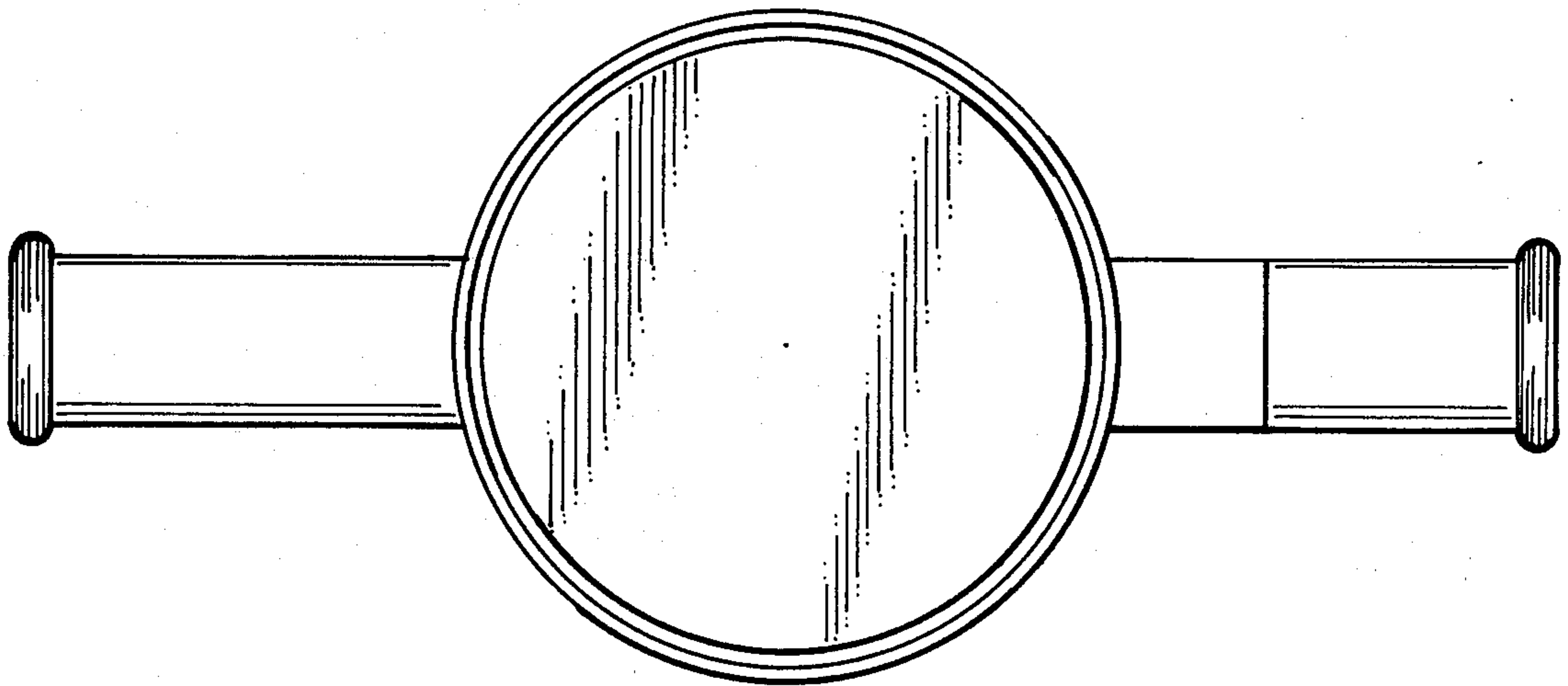

FIG. 6

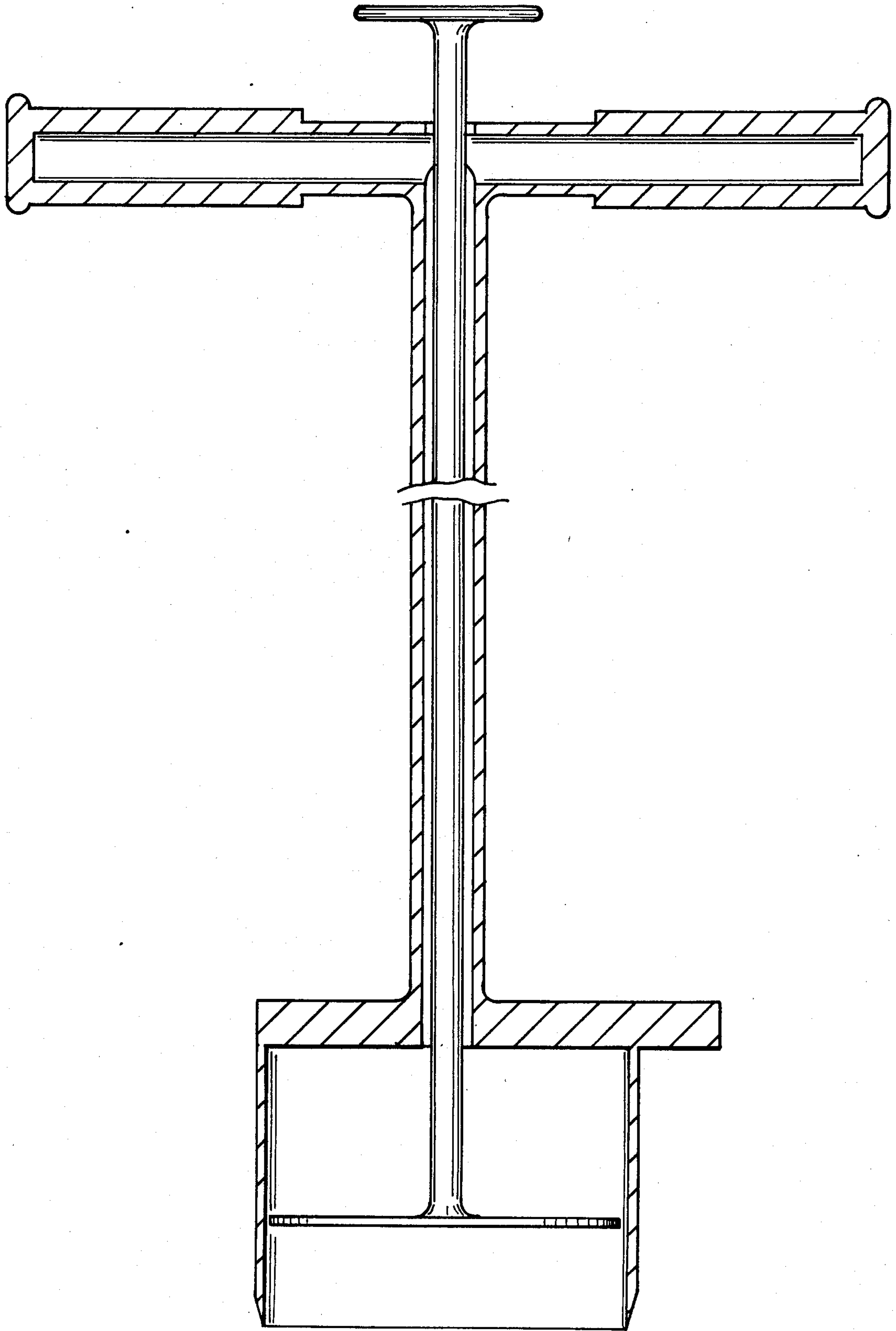



FIG. 7

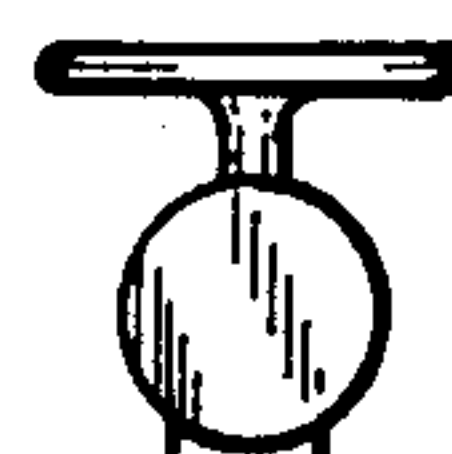

FIG. 9

FIG. 8

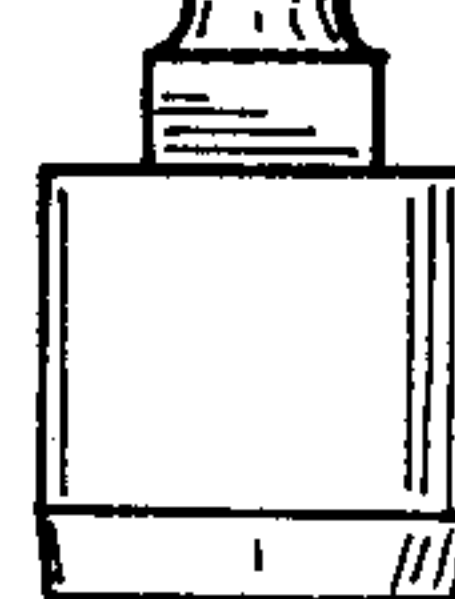
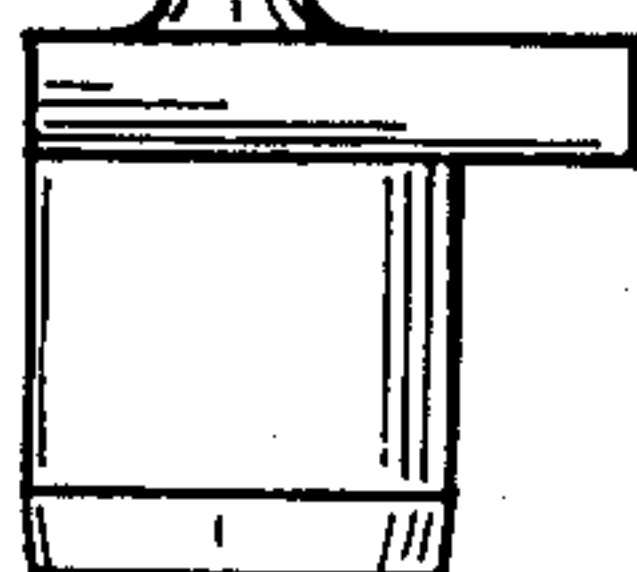
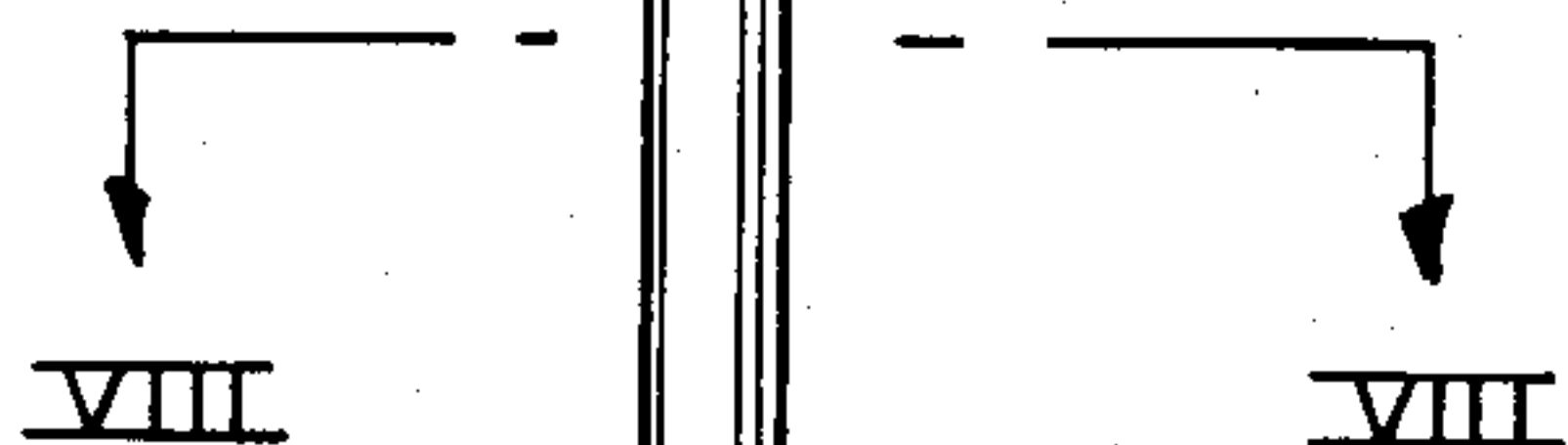
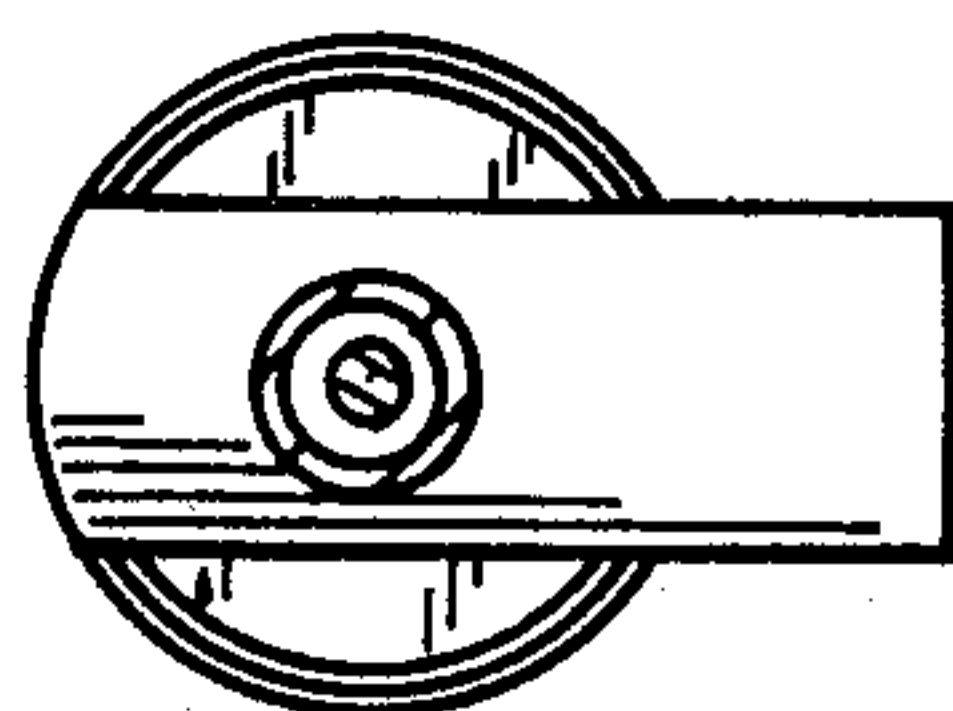

FIG. 10

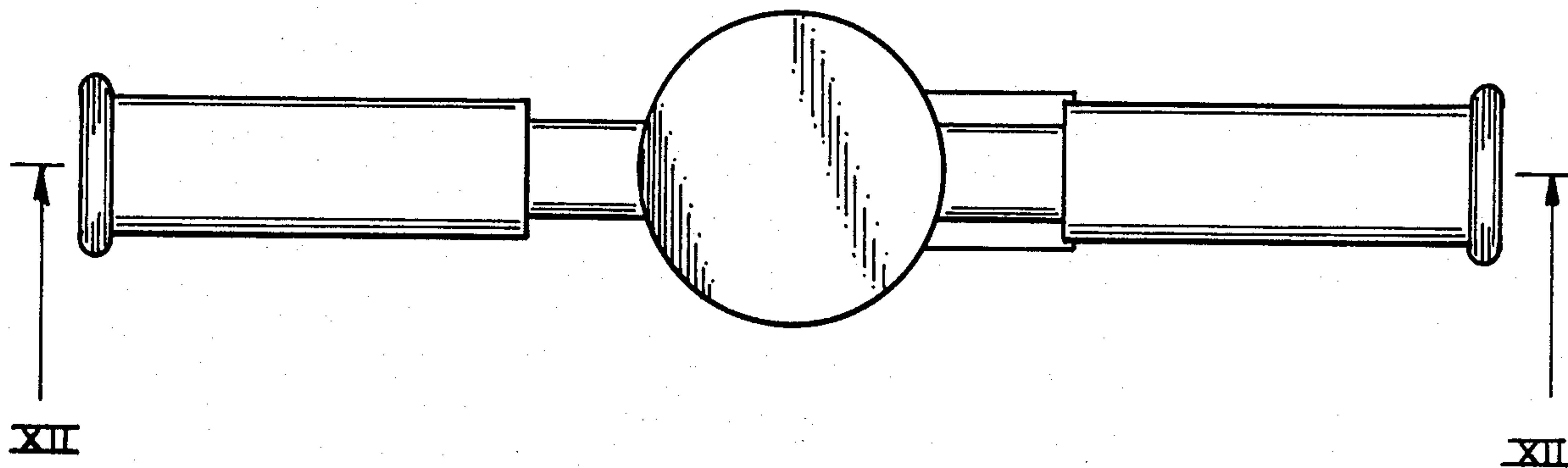
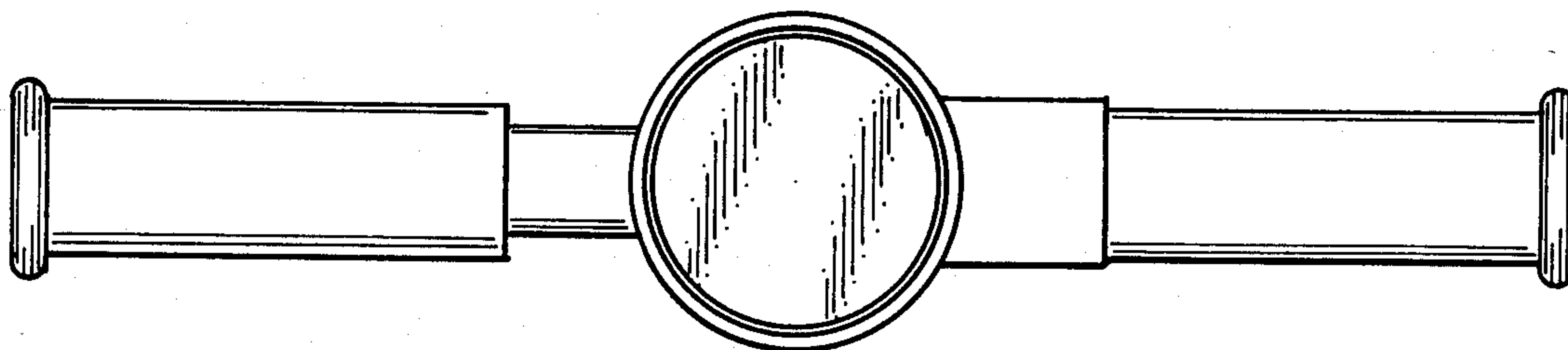

FIG. 11



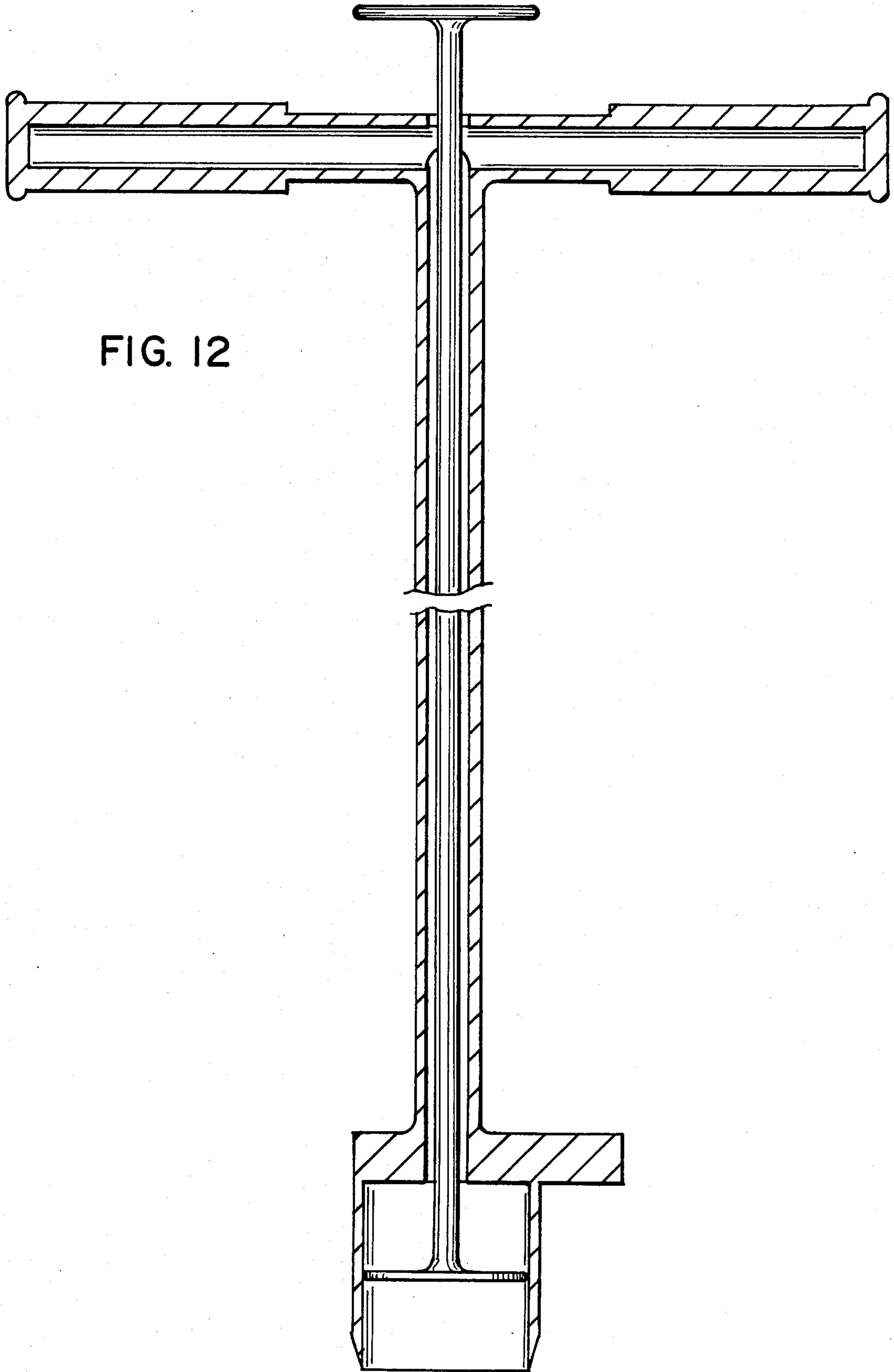

FIG. 12