

[54] **COSMETIC ORGANIZER**
[75] **Inventor: Lawrence R. Zall, Northbrook, Ill.**
[73] **Assignee: Allied of Chicago, Inc., Ill.**
[**] **Term: 14 Years**
[21] **Appl. No.: 920,885**
[22] **Filed: Oct. 20, 1986**
[52] **U.S. Cl. D28/76; D3/39**
[58] **Field of Search D28/38, 61, 99, 73-91;
D3/39; 206/235, 385, 581, 823; 362/135-137;
132/286, 288, 293, 294, 297-301, 303-305,
313-318**

[56] **References Cited**
U.S. PATENT DOCUMENTS
D. 252,409 7/1979 Rose et al. D28/76
FOREIGN PATENT DOCUMENTS
1008846 3/1983 United Kingdom .

1020503 11/1984 United Kingdom .

Primary Examiner—Louis S. Zarfes
Attorney, Agent, or Firm—Silverman, Cass, Singer & Winburn, Ltd.

[57] **CLAIM**
The ornamental design for cosmetic organizer, as shown and described.

DESCRIPTION
FIG. 1 is a front perspective view of a cosmetic organizer with its cover in closed position showing my new design;
FIG. 2 is a front perspective view thereof with the cover in open position;
FIG. 3 is a top plan view thereof;
FIG. 4 is a front elevational view thereof;
FIG. 5 is a bottom plan view thereof;
FIG. 6 is a rear elevational view thereof;
FIG. 7 is a right side elevational view thereof; and
FIG. 8 is a left side elevational view thereof.

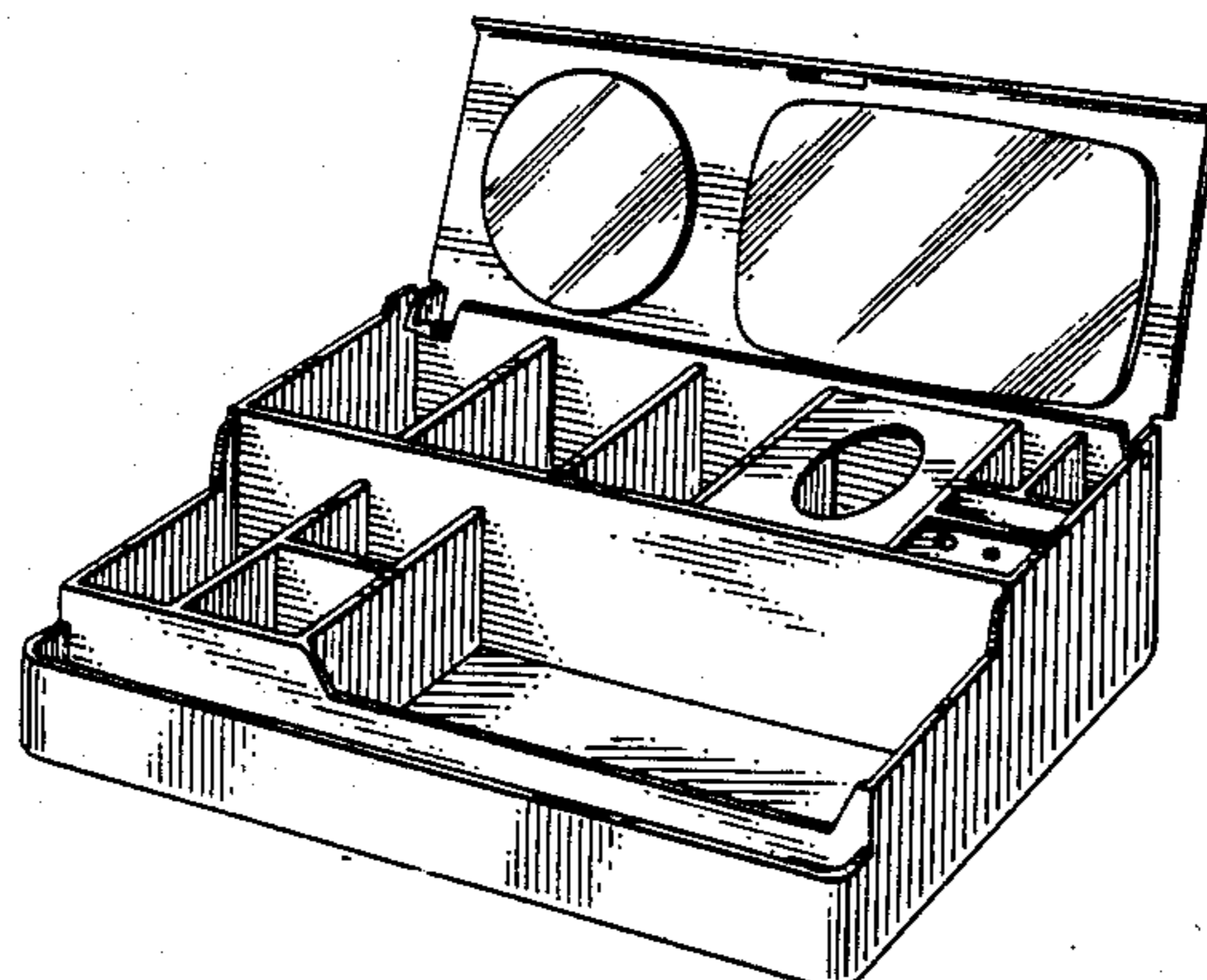
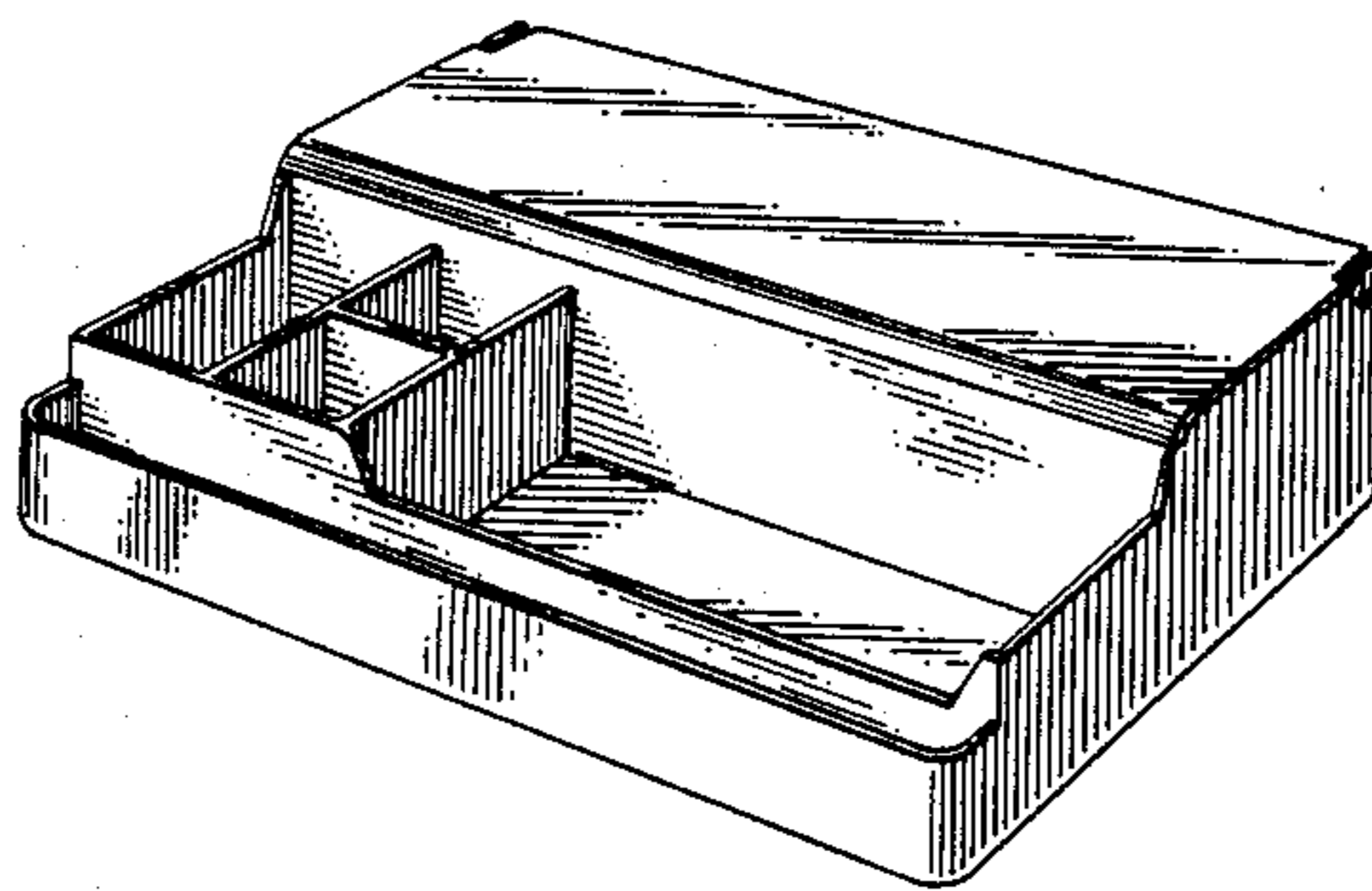

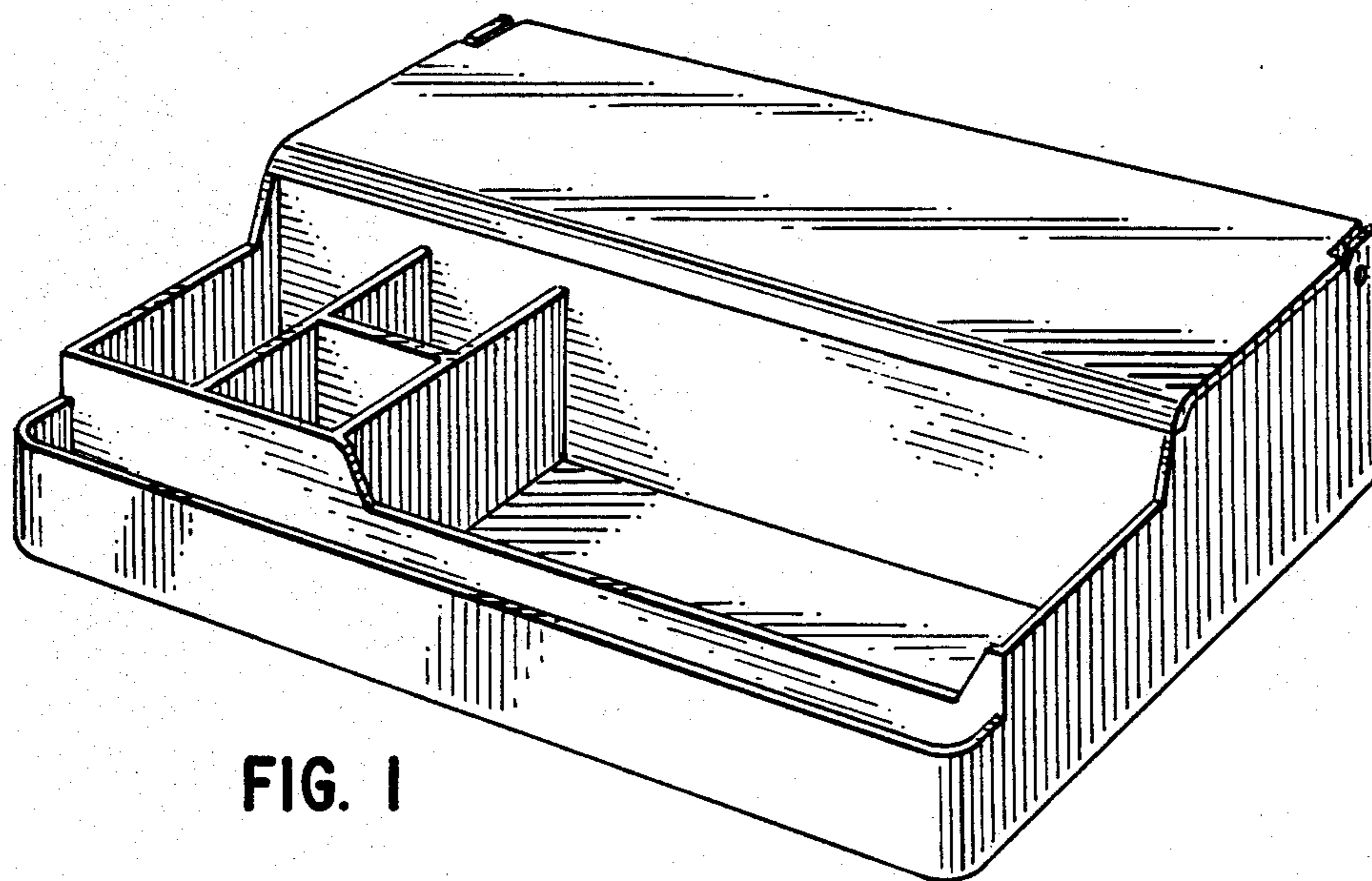

FIG. 1

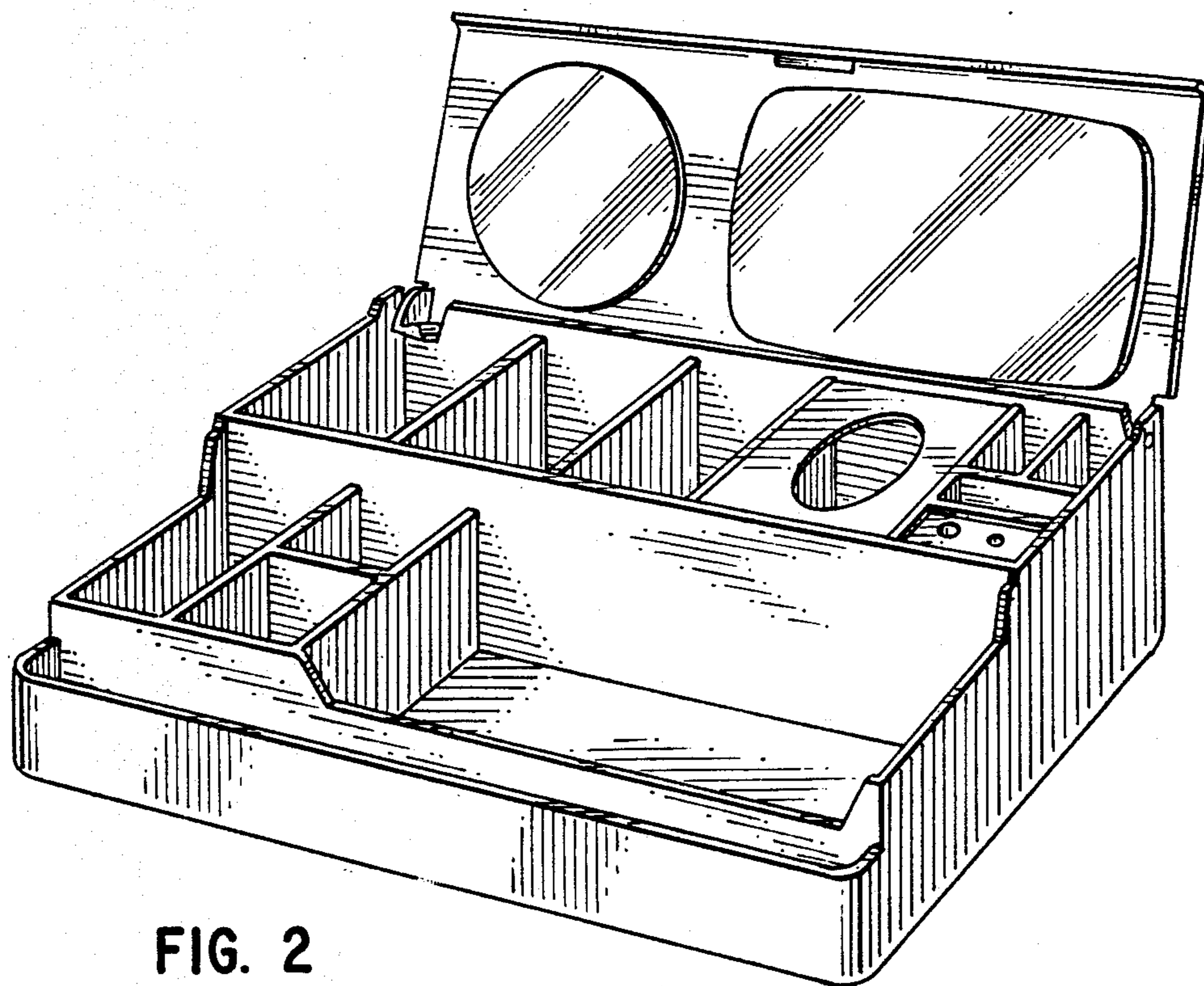

FIG. 2

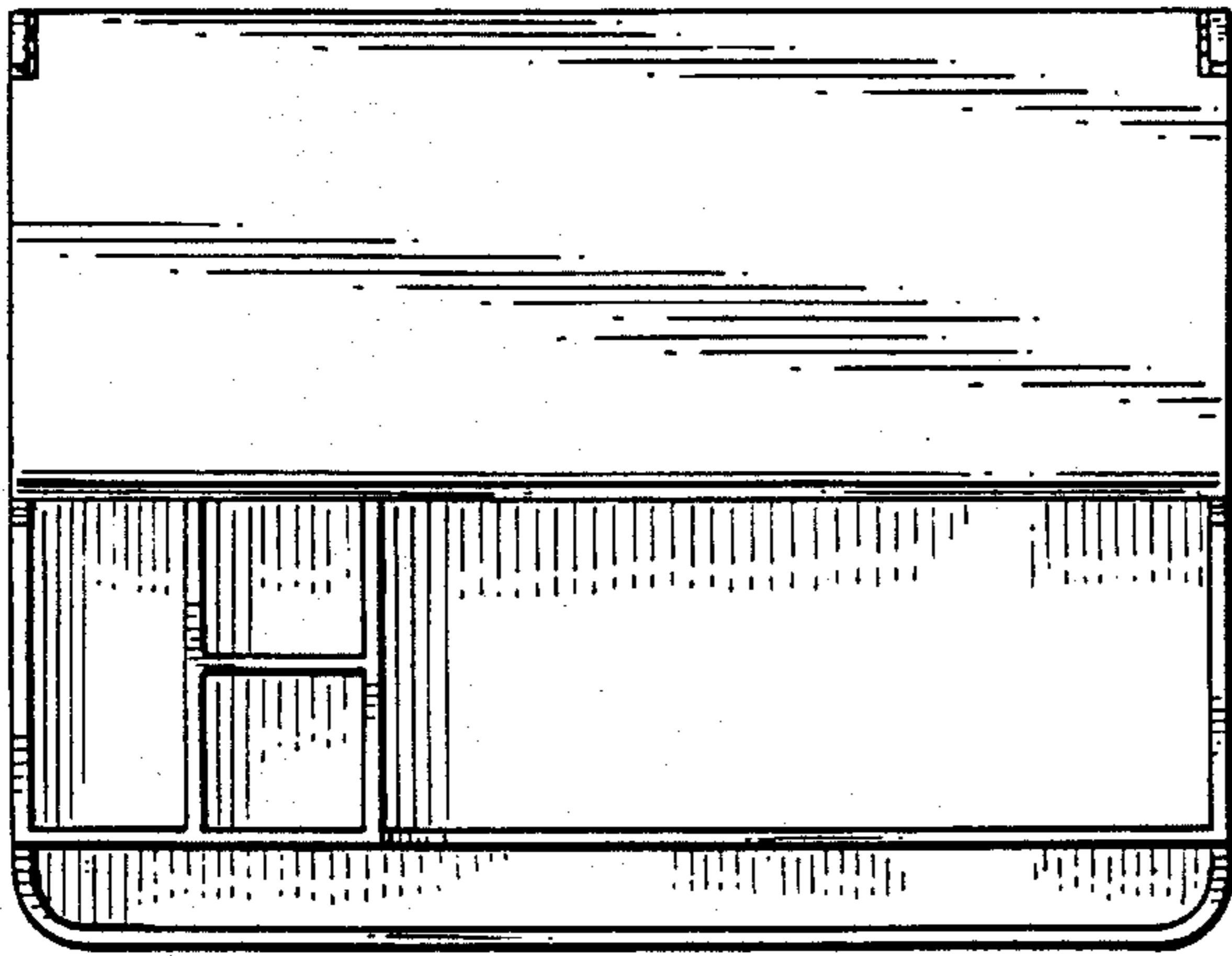

FIG. 3

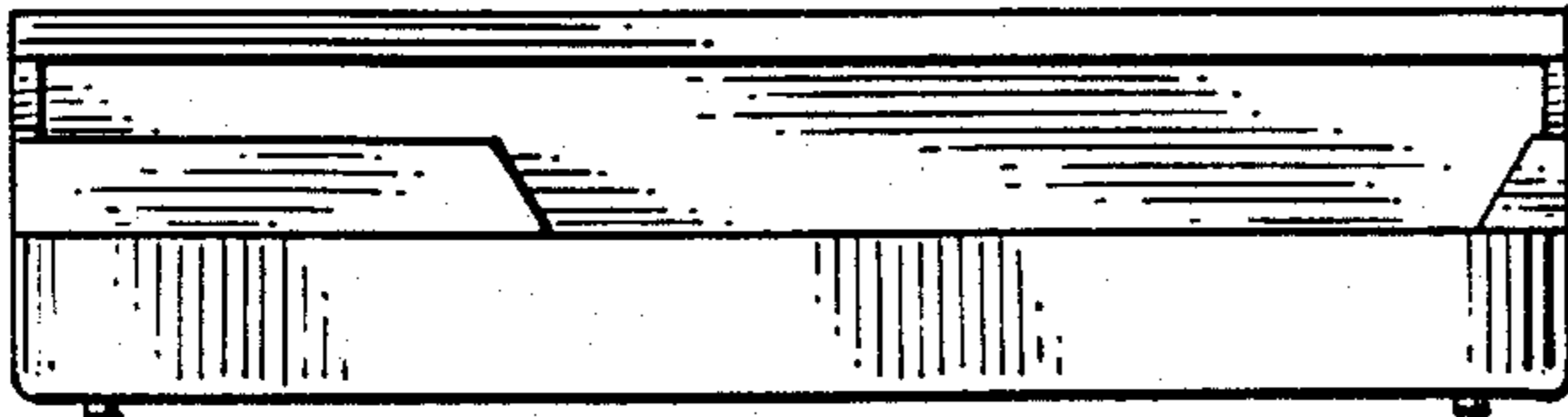

FIG. 4

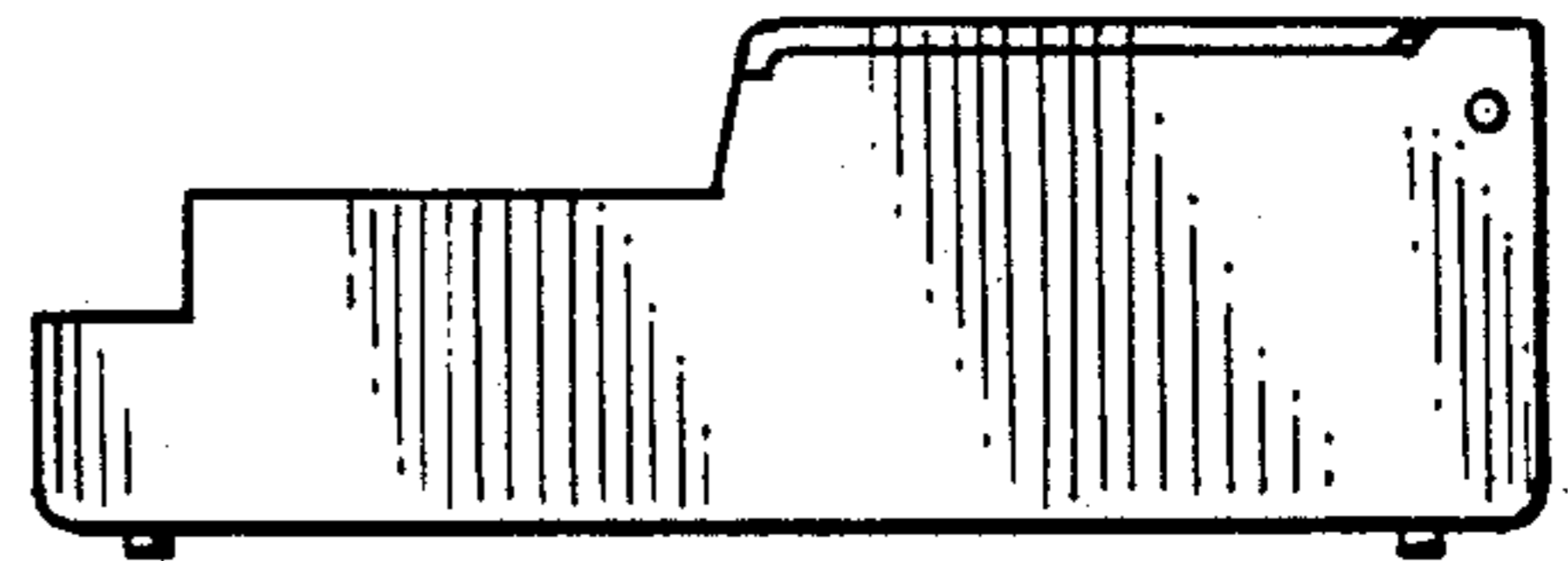

FIG. 7

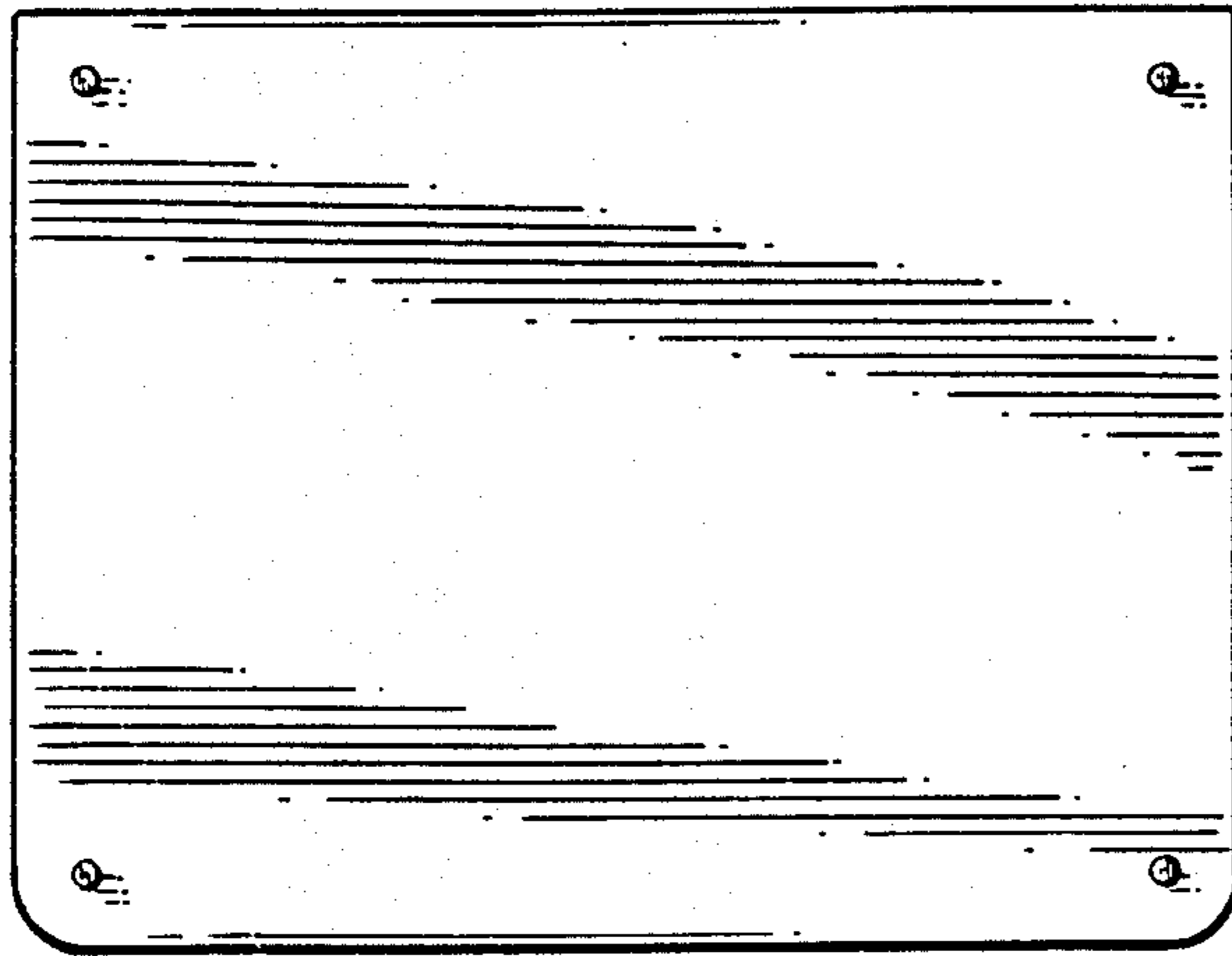

FIG. 5

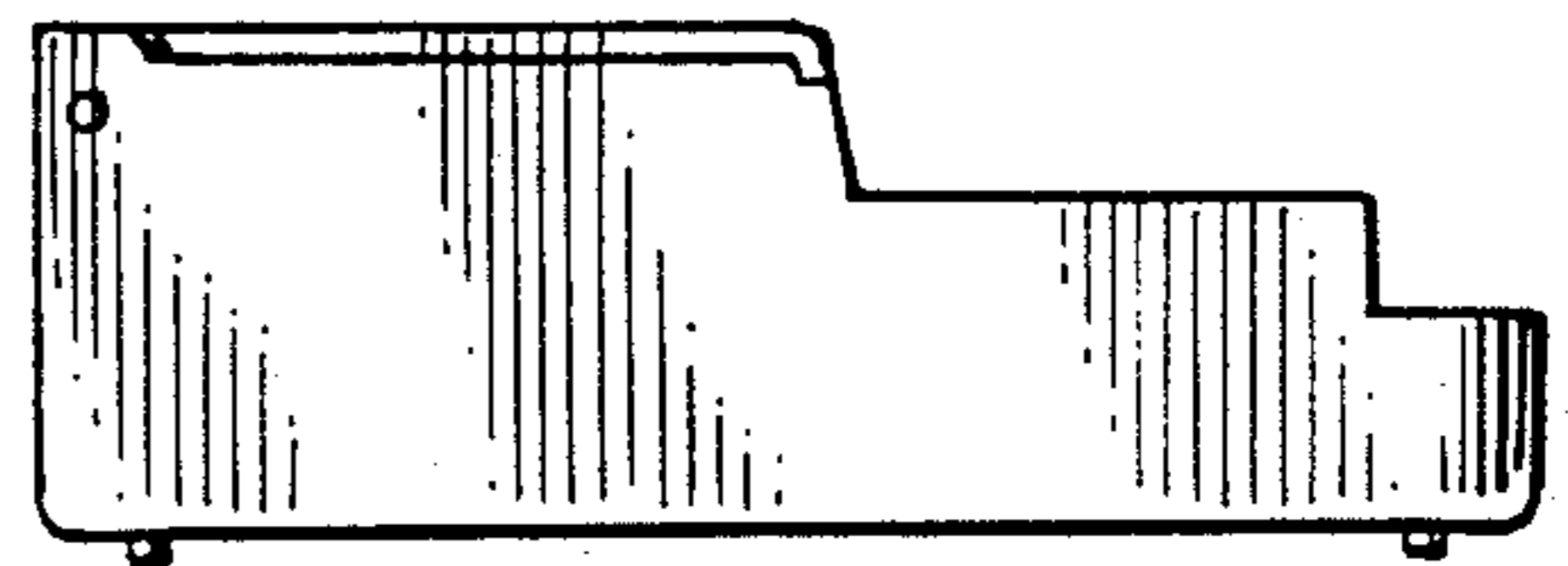

FIG. 8

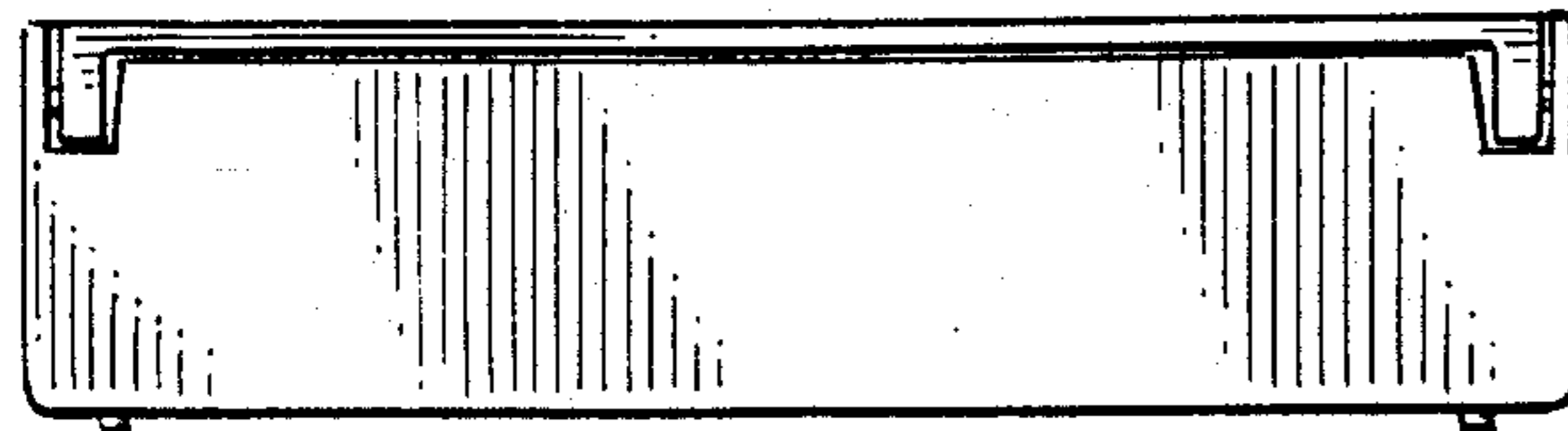

FIG. 6