

[54] COMBINED CAR SEAT AND STROLLER

4,679,804 7/1987 Johnson ..... 280/648

[75] Inventors: J. Camille Tucker; Klaus D. Weiswurm, both of San Antonio, Tex.

[73] Assignee: Gee-I-Go, Inc., San Antonio, Tex.

[\*\*] Term: 14 Years

[21] Appl. No.: 926,232

[22] Filed: Oct. 31, 1986

[52] U.S. Cl. .... D12/129; D6/333

[58] Field of Search ..... D12/129, 128, 130; 280/642, 643, 644, 42, 647, 648, 649, 650; 297/458, 459, 460, DIG. 4; D6/333, 339

[56] References Cited

U.S. PATENT DOCUMENTS

- D. 287,478 12/1986 Miles ..... D12/129
- D. 290,191 6/1987 Kassai ..... D6/333
- 3,970,325 7/1976 Wirsig ..... D12/130
- 4,570,956 2/1986 Dyer ..... 280/47.38
- 4,620,711 11/1986 Dick ..... D12/129
- 4,647,054 3/1987 Chong ..... 280/648

OTHER PUBLICATIONS

Popular Science, Oct. 1986, p. 58, Car-Seat Stroller.

Primary Examiner—Wallace R. Burke

Assistant Examiner—Kay H. Chin

Attorney, Agent, or Firm—Cox & Smith

[57] CLAIM

The ornamental design for a combined car seat and stroller, as shown and described.

DESCRIPTION

FIG. 1 is a top plan view of a combined car seat and stroller showing our new design;  
 FIG. 2 is a left side elevational view thereof;  
 FIG. 3 is a front elevational view thereof;  
 FIG. 4 is a right side elevational view thereof;  
 FIG. 5 is a rear elevational view thereof;  
 FIG. 6 is a bottom plan view thereof;  
 FIG. 7 is a rear perspective view thereof; and,  
 FIG. 8 is a front perspective view thereof, with the wheels pivoted and the handle and foot rest extended for use as a stroller.

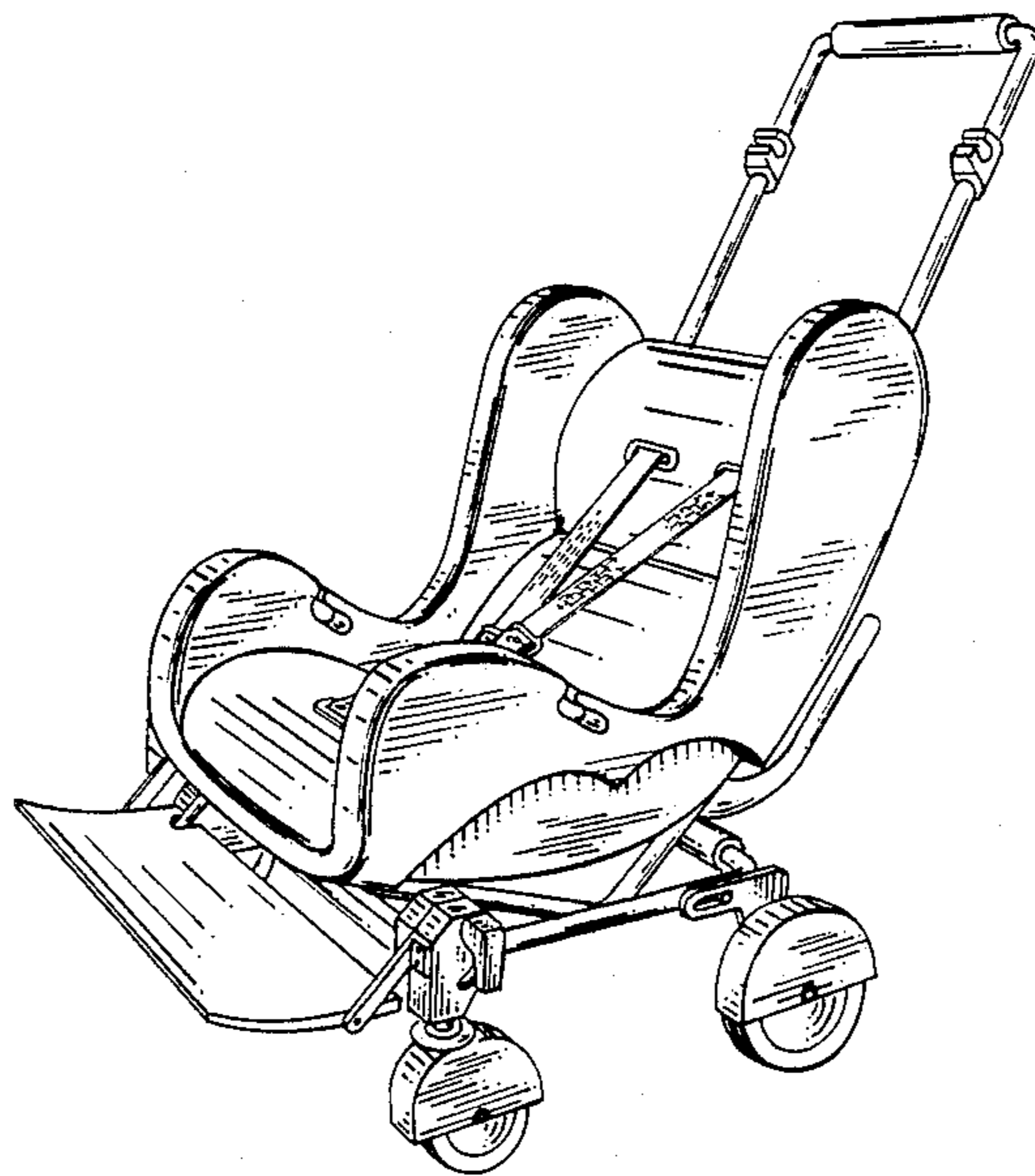

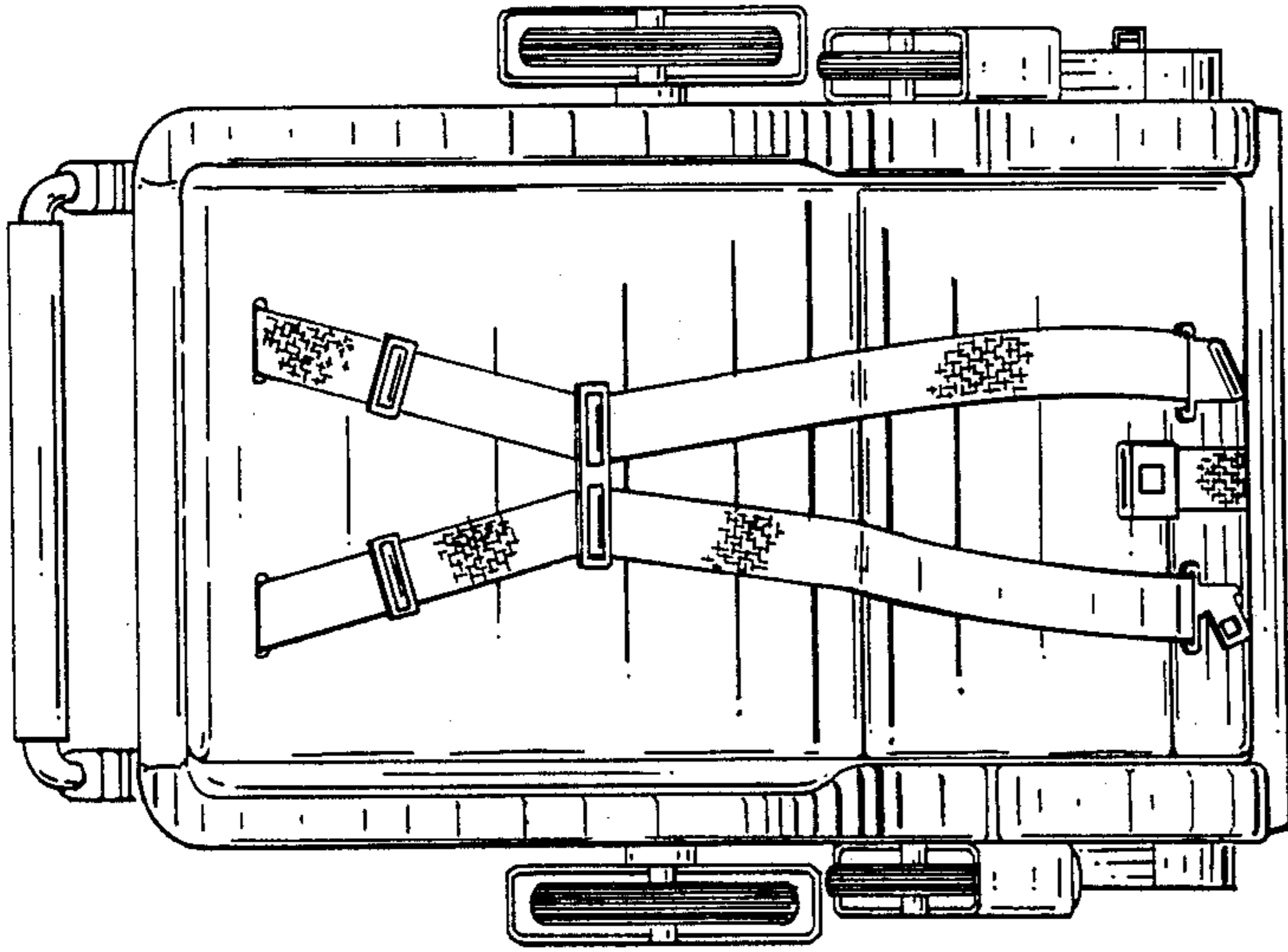

FIG. 1

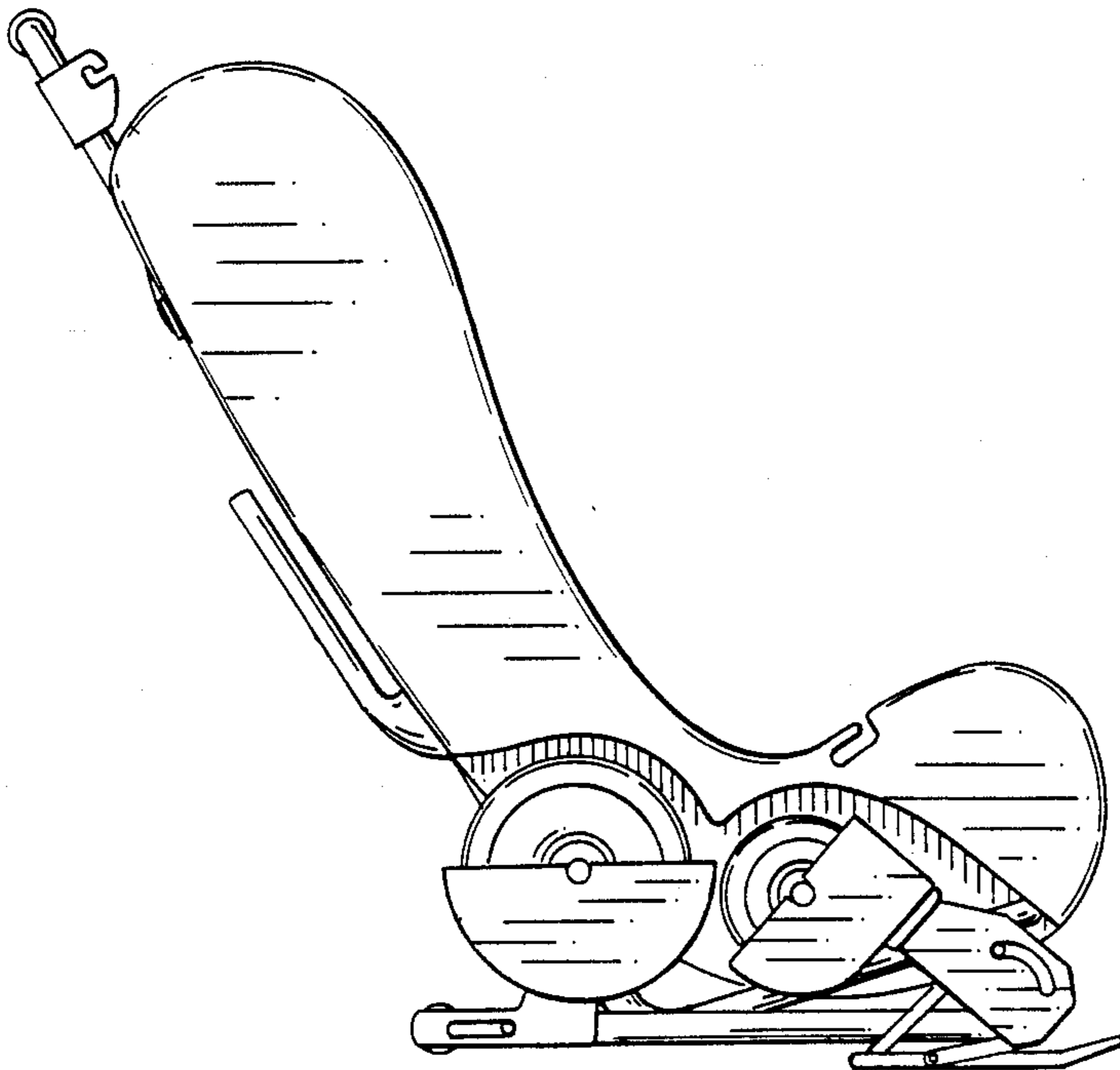

FIG. 2

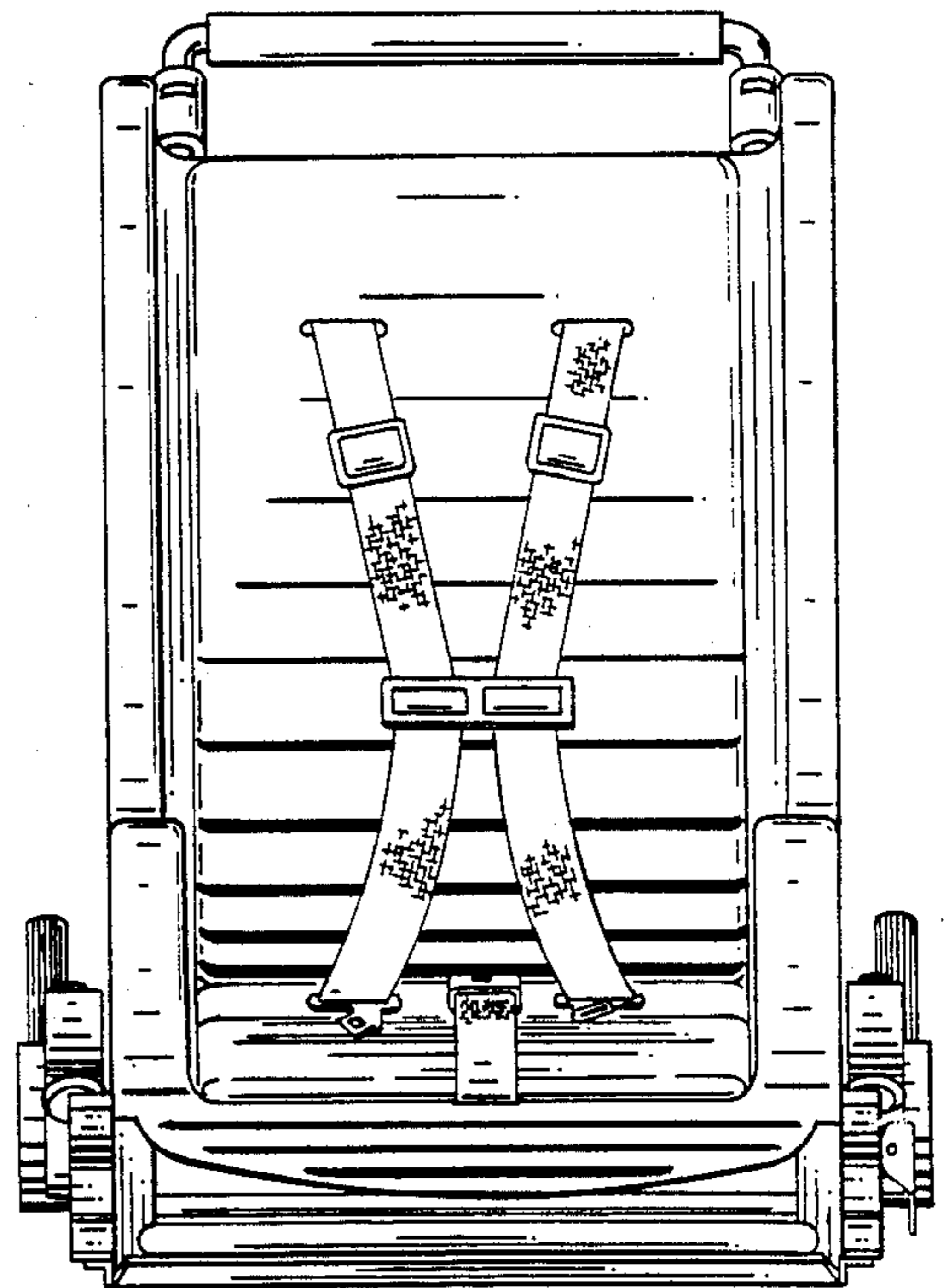

FIG. 3

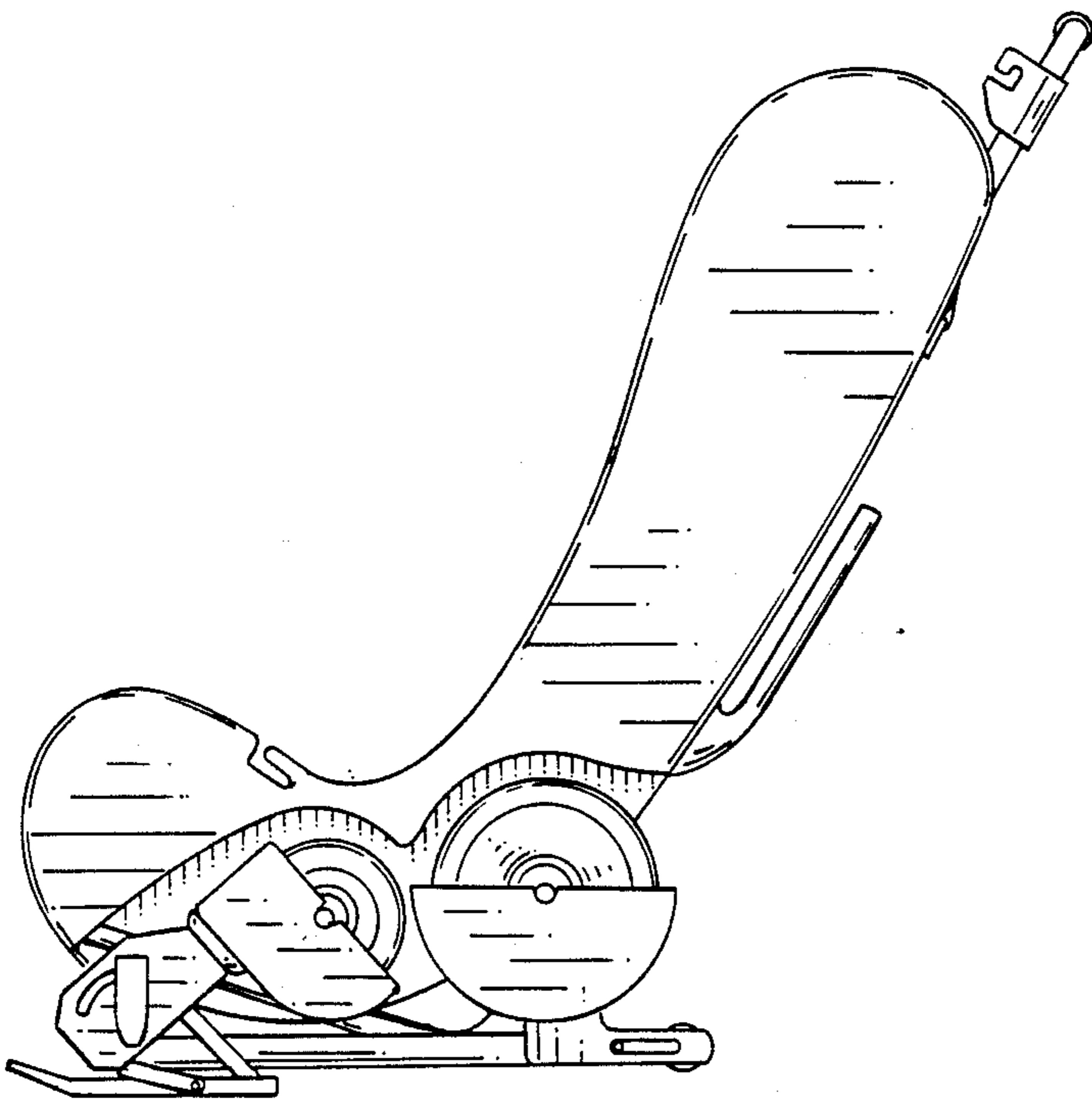

FIG. 4

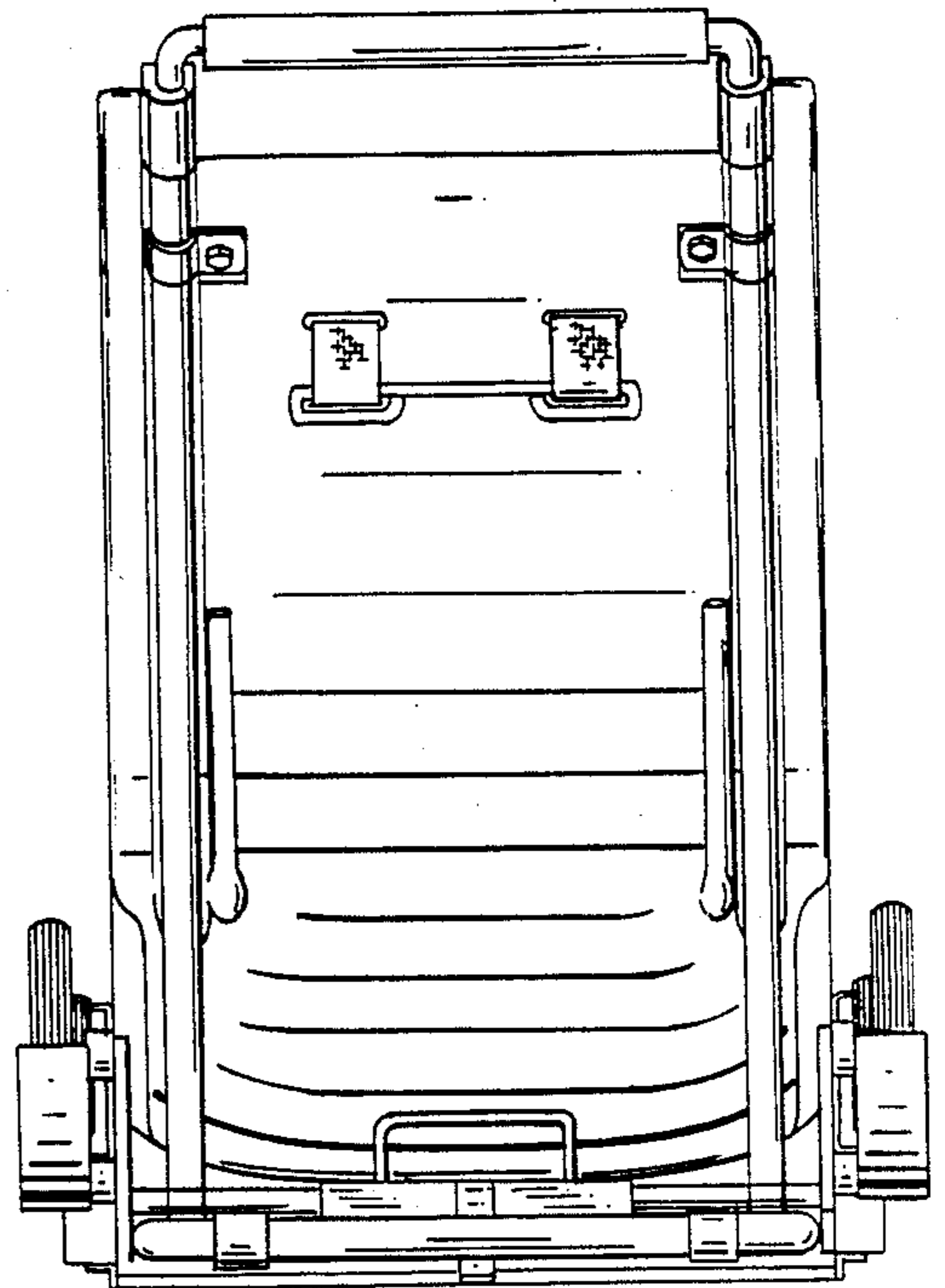

FIG. 5

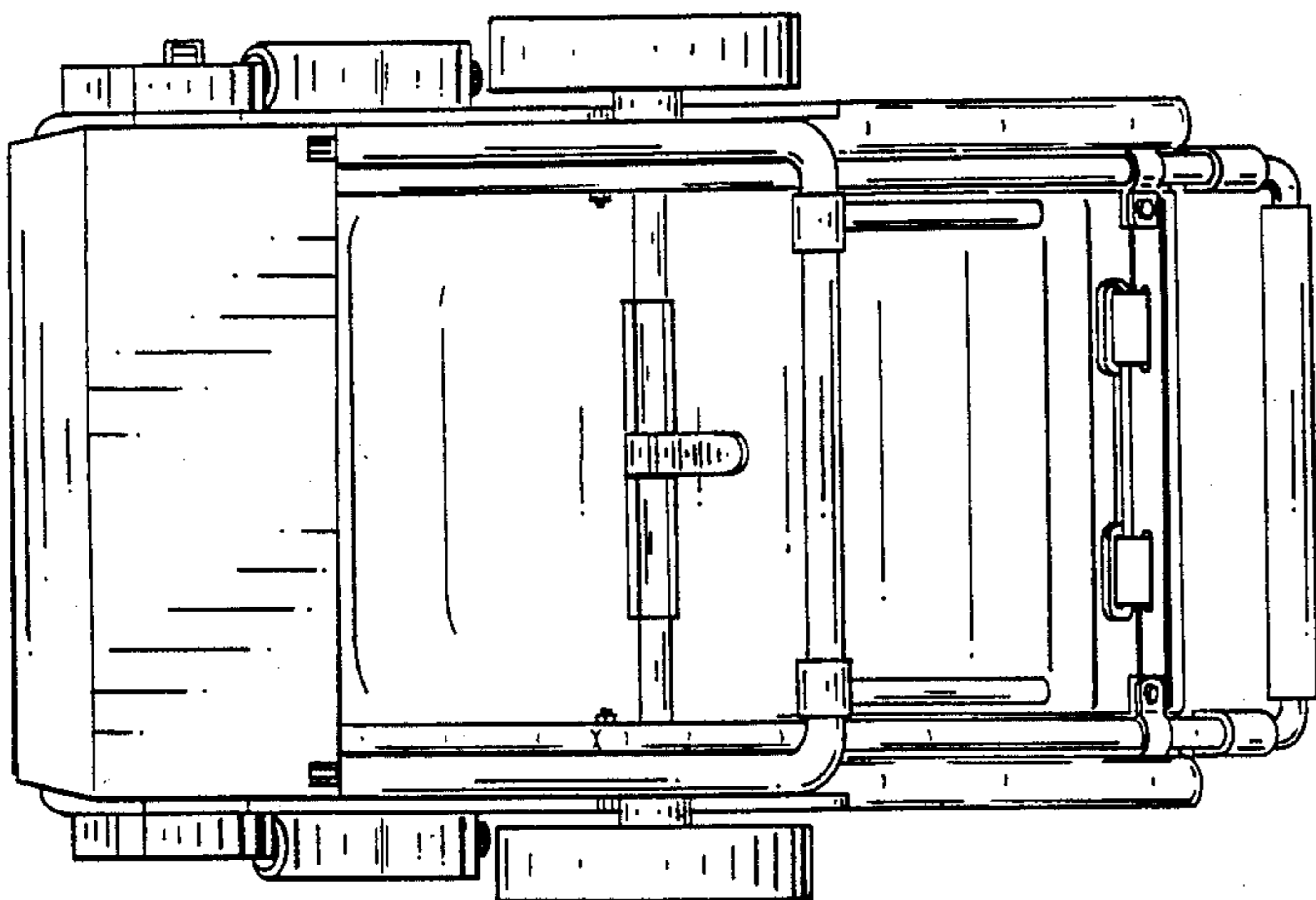

FIG. 6

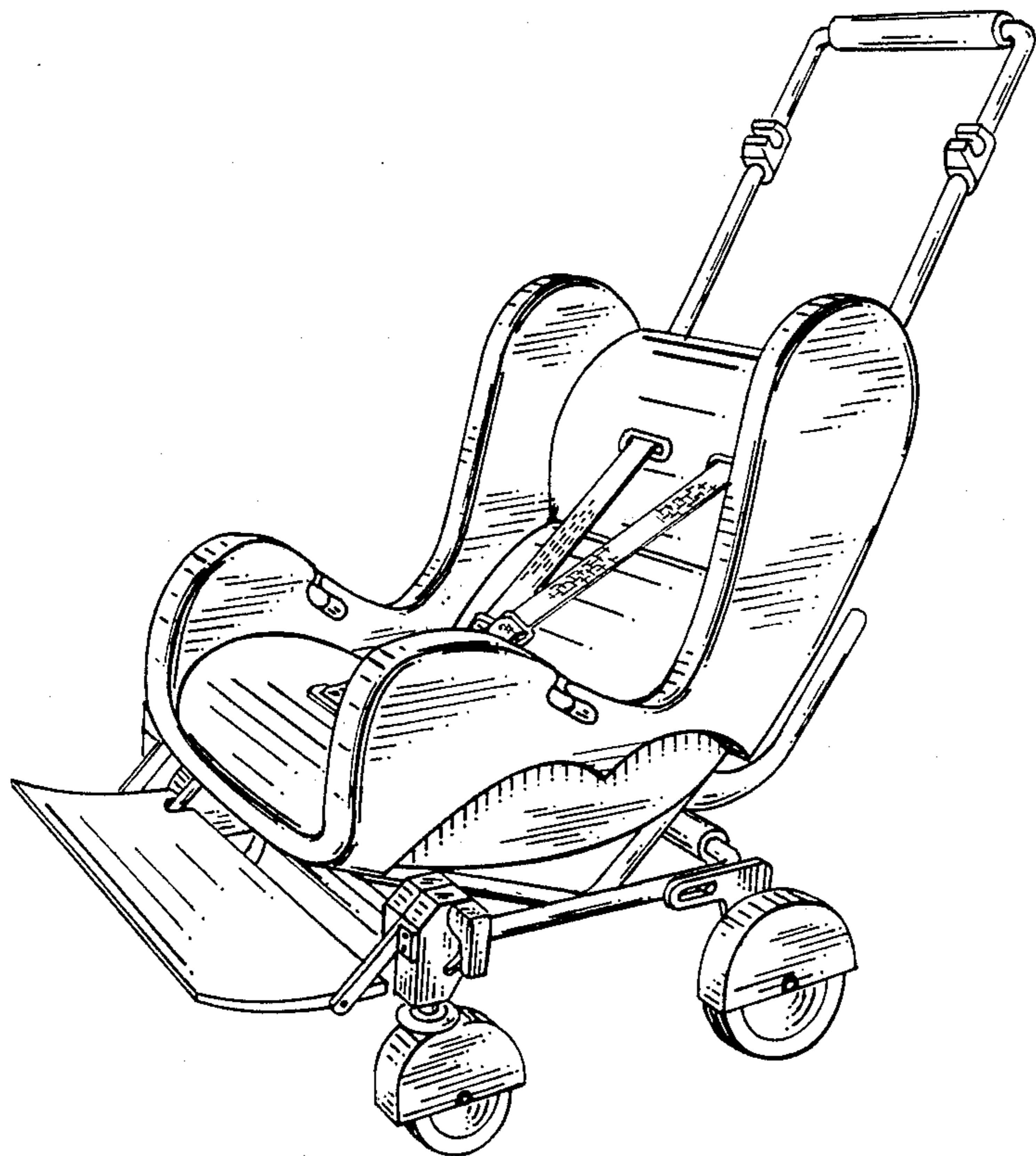

FIG. 8

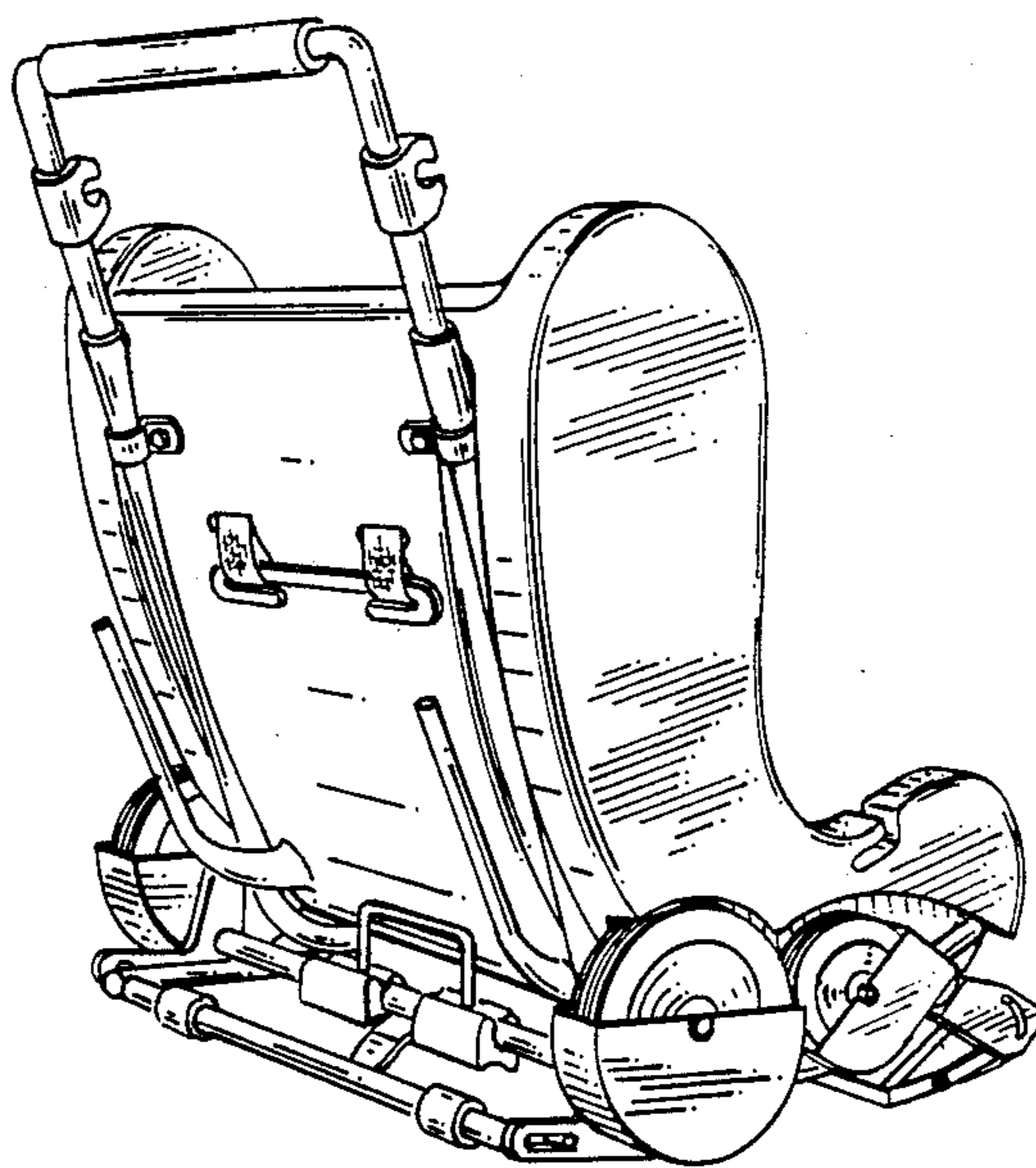

FIG. 7