

[54] ELECTRIC SHAVER

[75] Inventor: Gerald J. Rubin, El Paso, Tex.

[73] Assignee: Helen of Troy, El Paso, Tex.

[**] Term: 14 Years

[21] Appl. No.: 879,551

[22] Filed: Jun. 27, 1986

[52] U.S. Cl. D28/53

[58] Field of Search D28/44-54;
30/30-32, 34 R, 41.9, 42, 43, 43.3-43.92, 44, 45,
85, 86, 90, 200-202, 210, 220

[56] References Cited

U.S. PATENT DOCUMENTS

D. 95,255	4/1935	Hill	D28/53
D. 214,414	6/1969	Madl	D28/53
D. 225,186	11/1972	Ono et al.	D28/46 X
D. 260,562	9/1981	Mack et al.	D28/53
1,407,748	2/1922	Hermann	30/30 X
2,702,940	3/1955	Dickerson	30/201

FOREIGN PATENT DOCUMENTS

106689 6/1927 Austria 30/220

Primary Examiner—Louis S. Zarfaz

Attorney, Agent, or Firm—Berman, Aisenberg & Platt

[57] CLAIM

The ornamental design for an electric shaver, as shown and described.

DESCRIPTION

FIG. 1 is a left side elevational view of an electric shaver showing my new design;

FIG. 2 is a front elevational view thereof with the cover separated from the body;

FIG. 3 is a top plan view of the cover alone;

FIG. 4 is a right side elevational view with the cover removed;

FIG. 5 is a rear elevational view thereof;

FIG. 6 is a top plan view thereof; and,

FIG. 7 is a bottom plan view thereof.

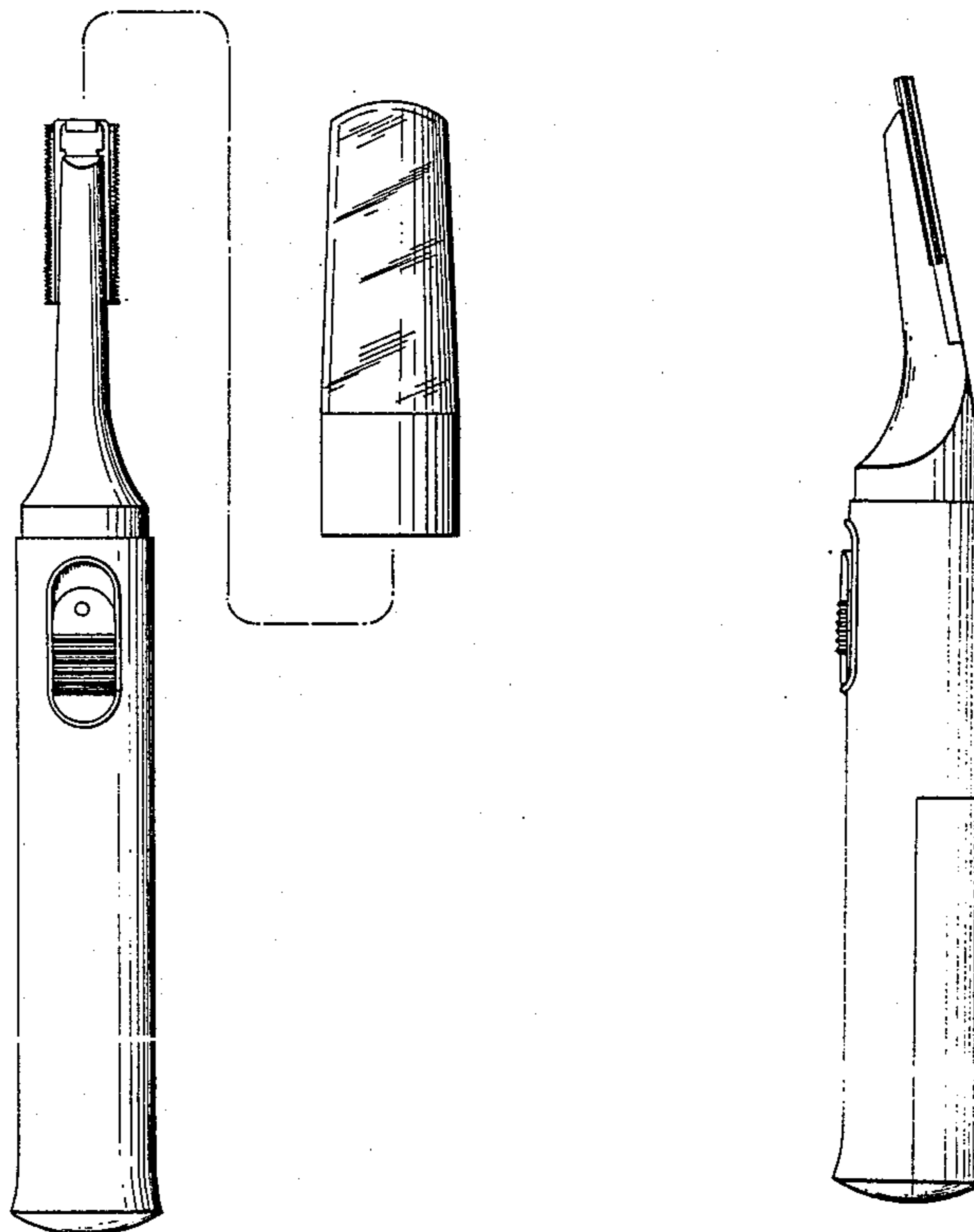

FIG. 1

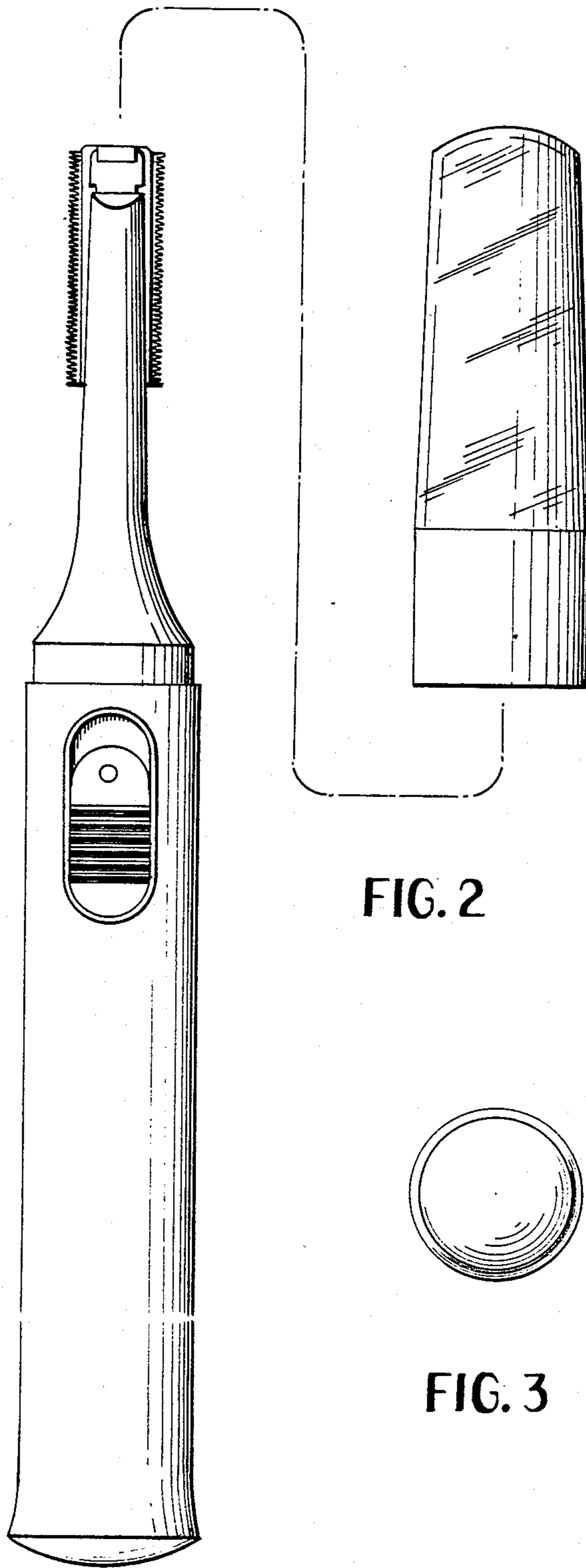
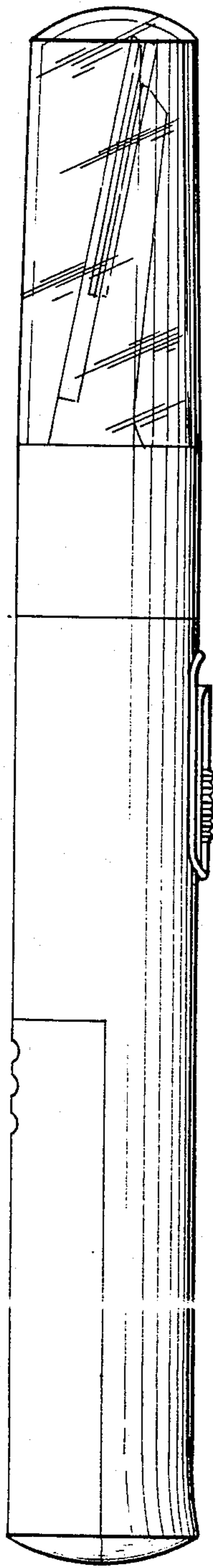

FIG. 2

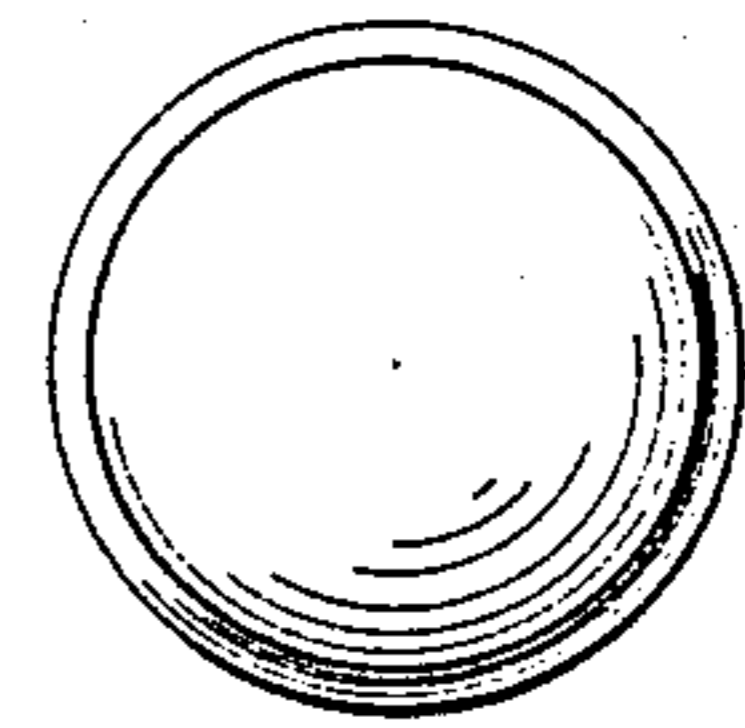

FIG. 3

FIG. 4

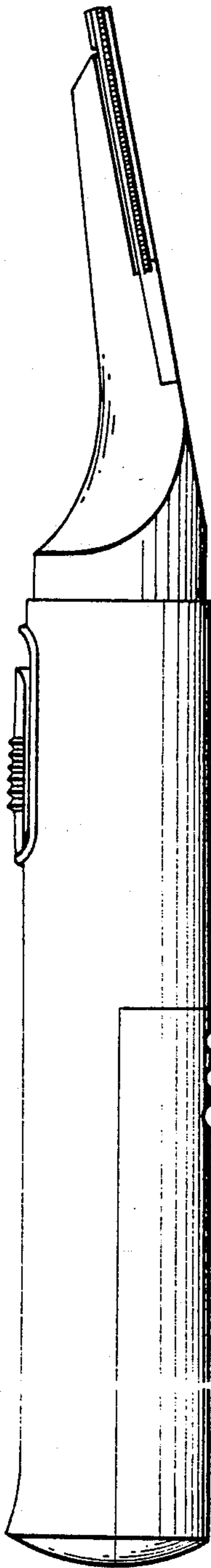

FIG. 5

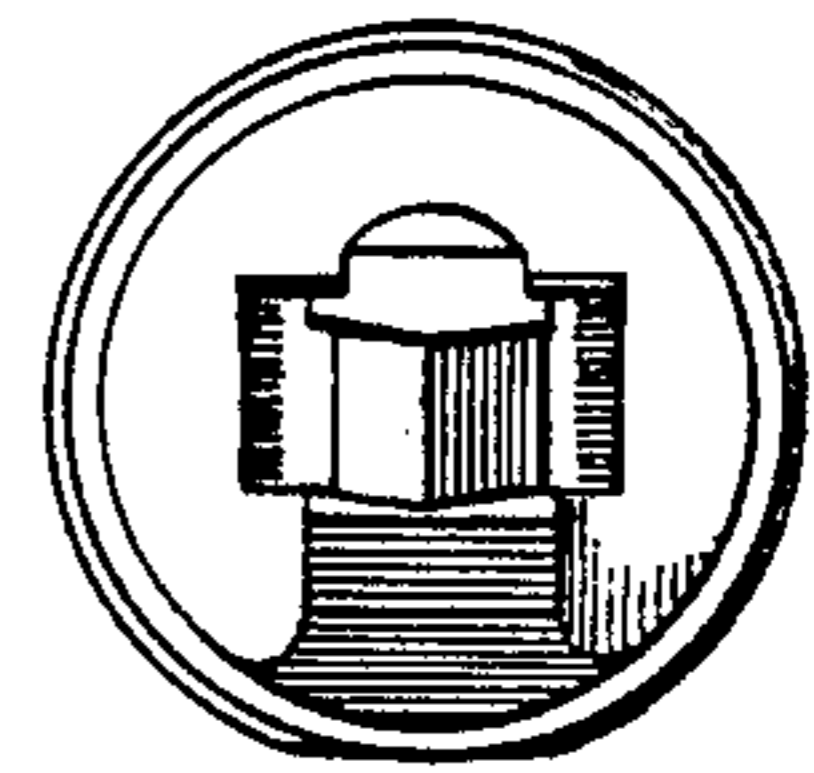
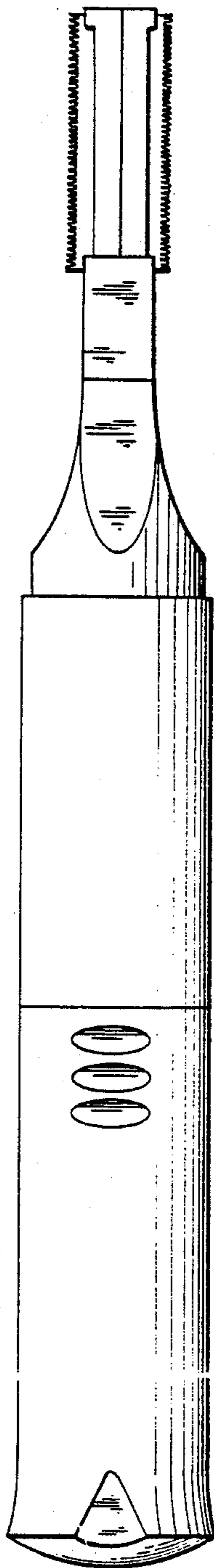

FIG. 6

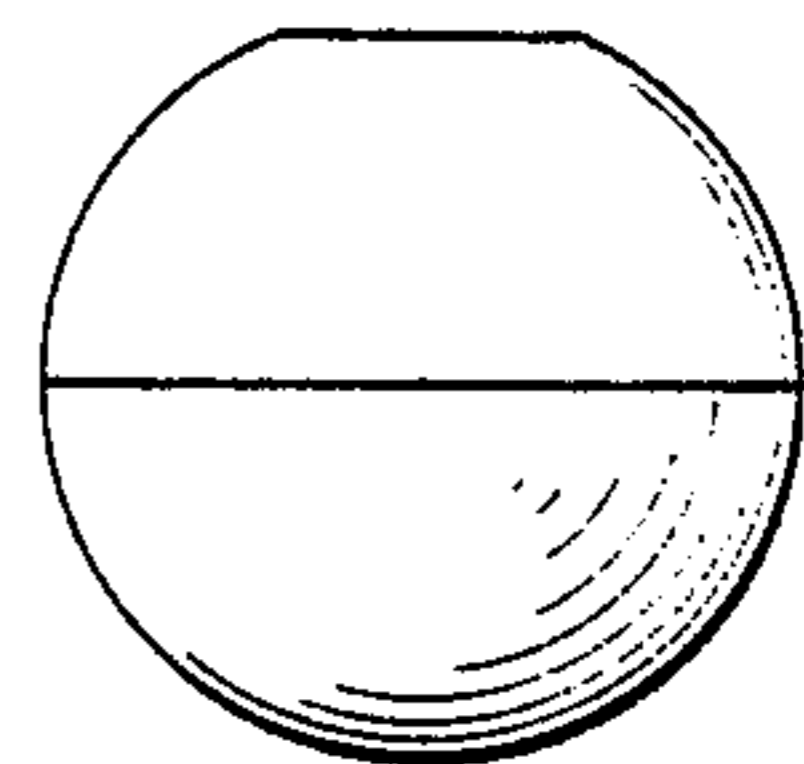

FIG. 7