

[54] PORTABLE OUTDOOR FIREPLACE

[76] Inventor: James W. Gatton, P.O. Box 27, State Rte. 97, West, Bellville, Ohio 44813

[**] Term: 14 Years

[21] Appl. No.: 927,419

[22] Filed: Nov. 5, 1986

[52] U.S. Cl. D23/348; D23/343

[58] Field of Search D23/332, 314, 336, 338-339, D23/343-348, 386, 397, 403; 126/58, 60-66, 85 R, 120-122, 126, 138-144, 152, 164-165, 190, 198, 200, 9 R; D7/332, 337, 360, 366

[56] References Cited

U.S. PATENT DOCUMENTS

- D. 189,469 12/1960 Fischer D23/366
- D. 226,726 4/1973 Eckstein D23/366
- 3,398,264 8/1968 Katzman et al. D23/360 X
- 3,777,735 12/1973 Miller D23/343 X
- 3,910,251 10/1975 Andrew 126/120

OTHER PUBLICATIONS

Weber Catalogue (1985), p. 24, Model 2710.

Primary Examiner—Wallace R. Burke

Assistant Examiner—Brian N. Vinson

Attorney, Agent, or Firm—Robert E. Stebens

[57] CLAIM

The ornamental design for a portable outdoor fireplace, as shown and described.

DESCRIPTION

FIG. 1 is a top perspective view of a portable outdoor fireplace showing my new design;

FIG. 2 is a top plan view of the base portion thereof, the cover being omitted for clarity of illustration;

FIG. 3 is a side elevational view thereof, the opposite and adjacent sides being identical in appearance to that shown;

FIG. 4 is a bottom plan view thereof;

FIG. 5 is a top perspective view of the base portion thereof;

FIG. 6 is an enlarged fragmentary vertical cross-sectional view thereof, taken along line 6—6 of FIG. 1;

FIG. 7 is an alternate embodiment of a portable outdoor fireplace, the cover, identical in appearance to that shown in FIG. 1, being omitted for clarity of illustration;

FIG. 8 is a top plan view of the base portion of the embodiment of FIG. 7;

FIG. 9 is a side elevational view of the embodiment of FIG. 7, the opposite side being a mirror image of that shown; and,

FIG. 10 is a bottom plan view of the embodiment of FIG. 7.

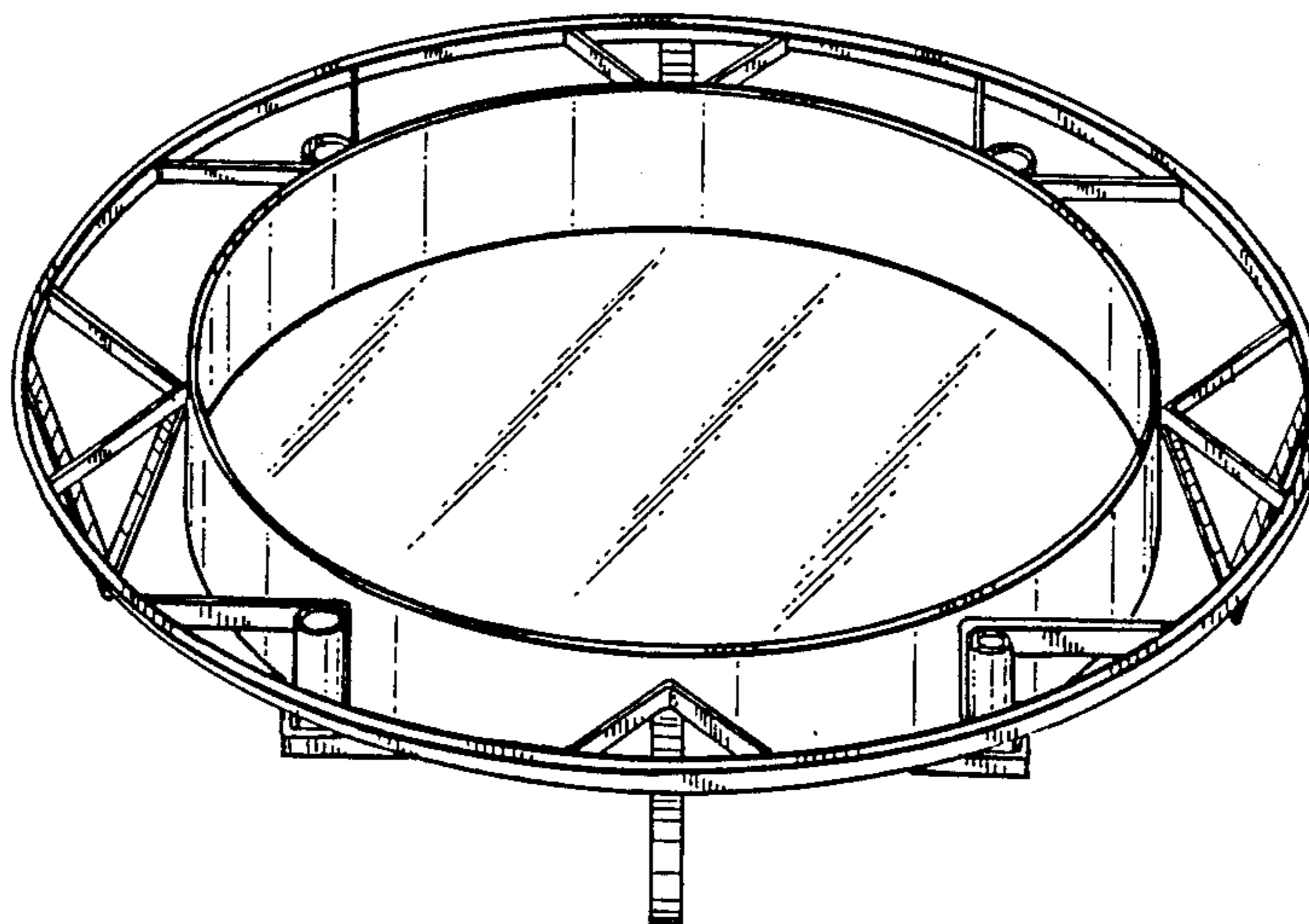

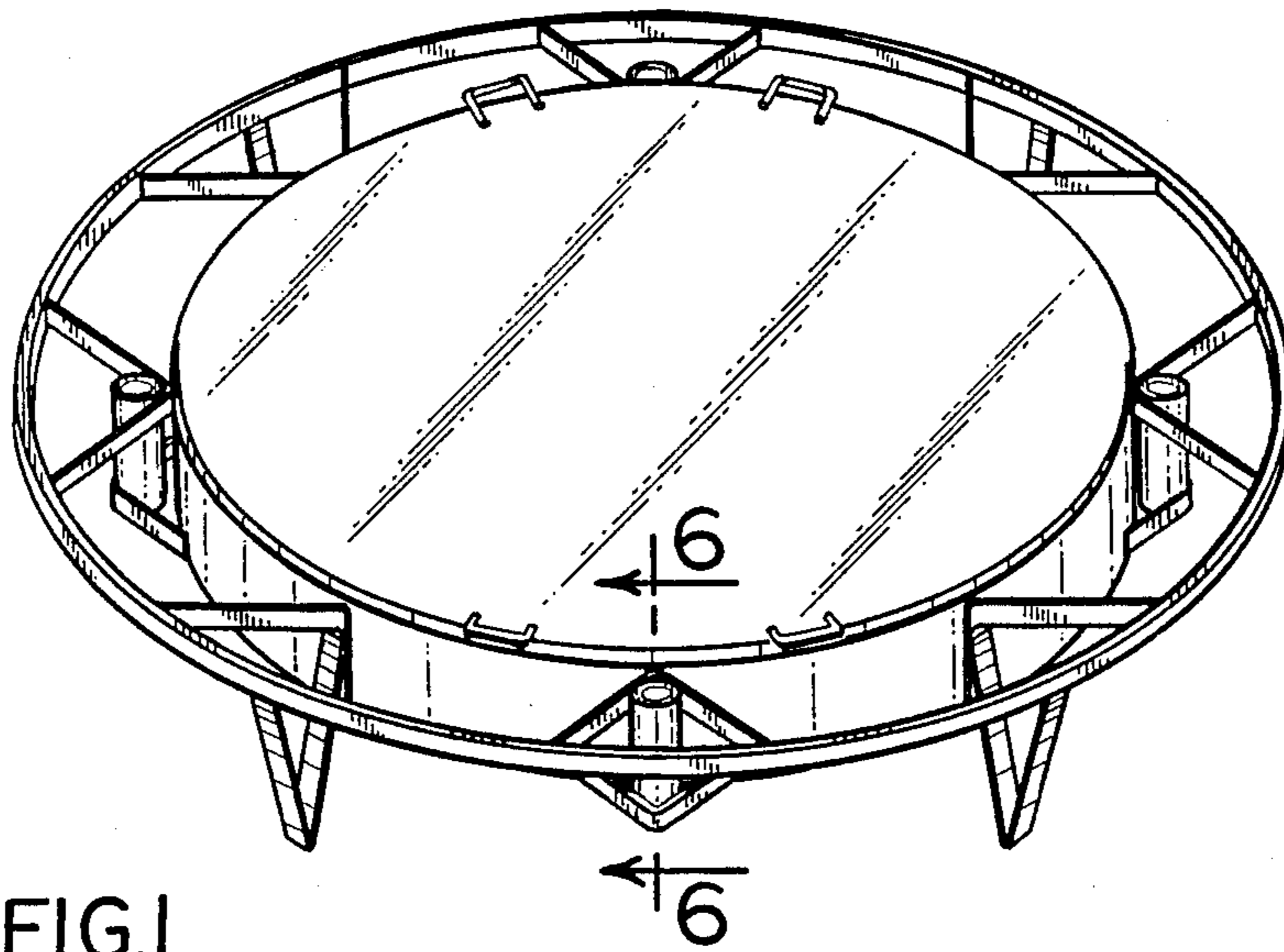

FIG. 1

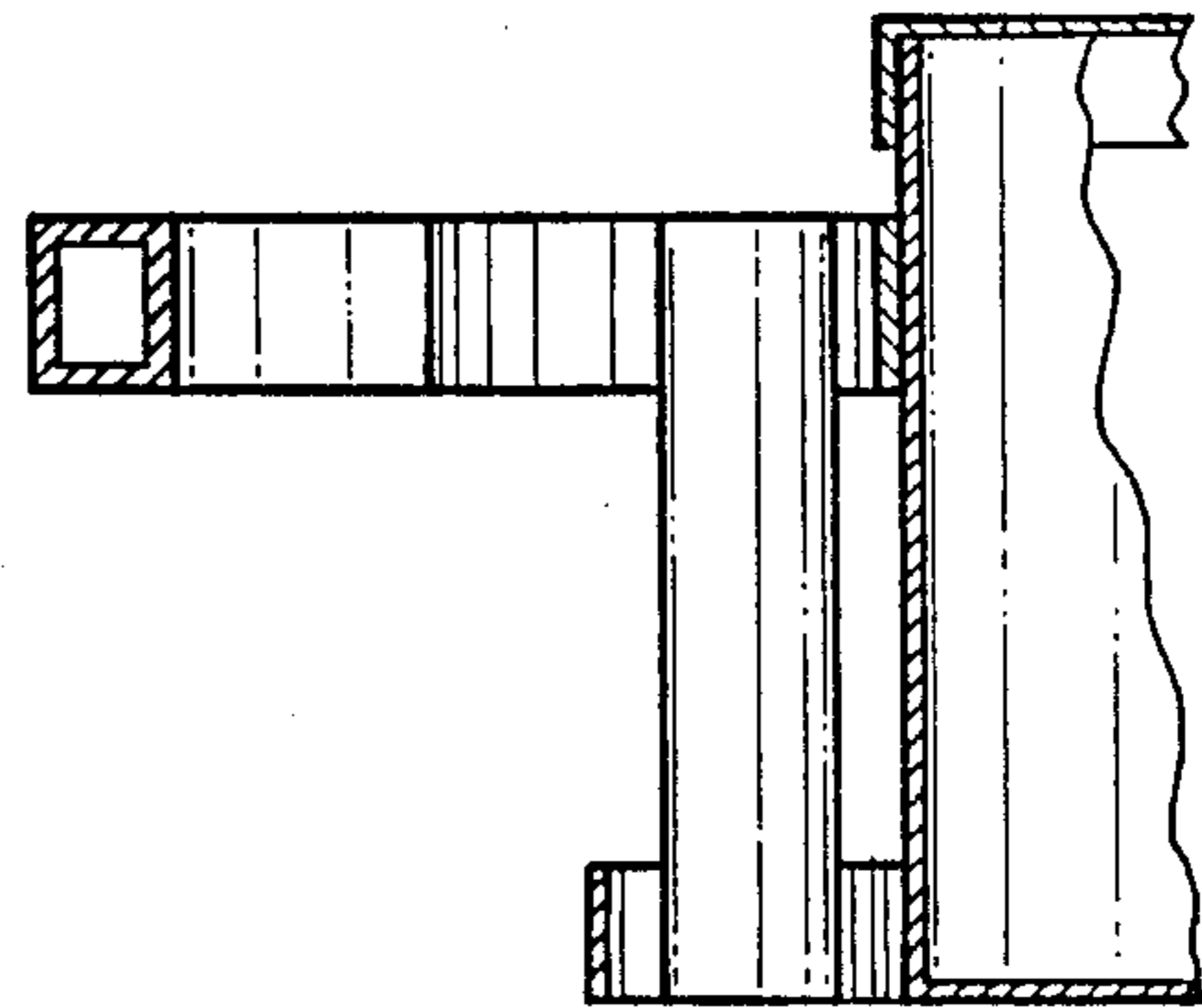

FIG. 6

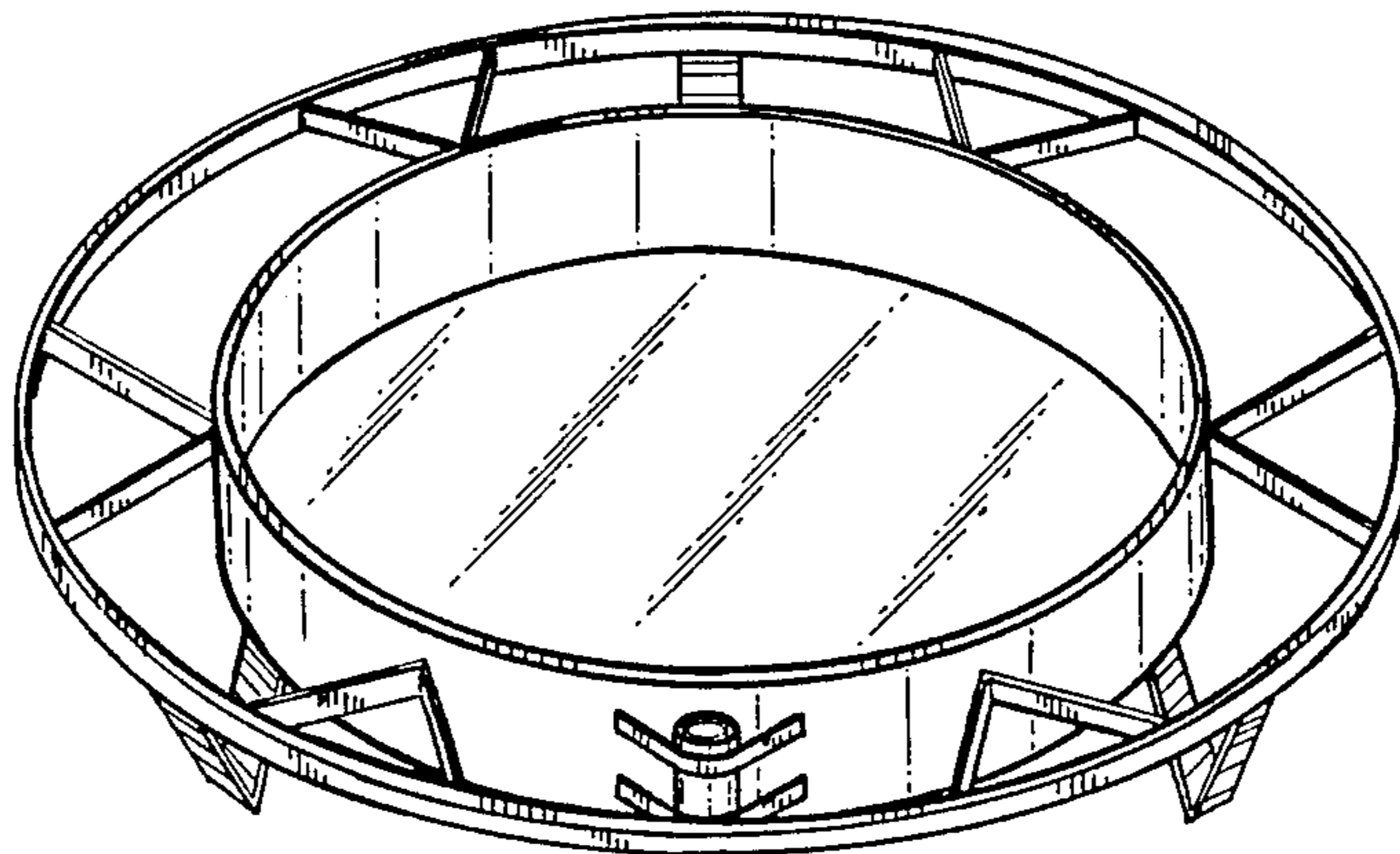

FIG. 7

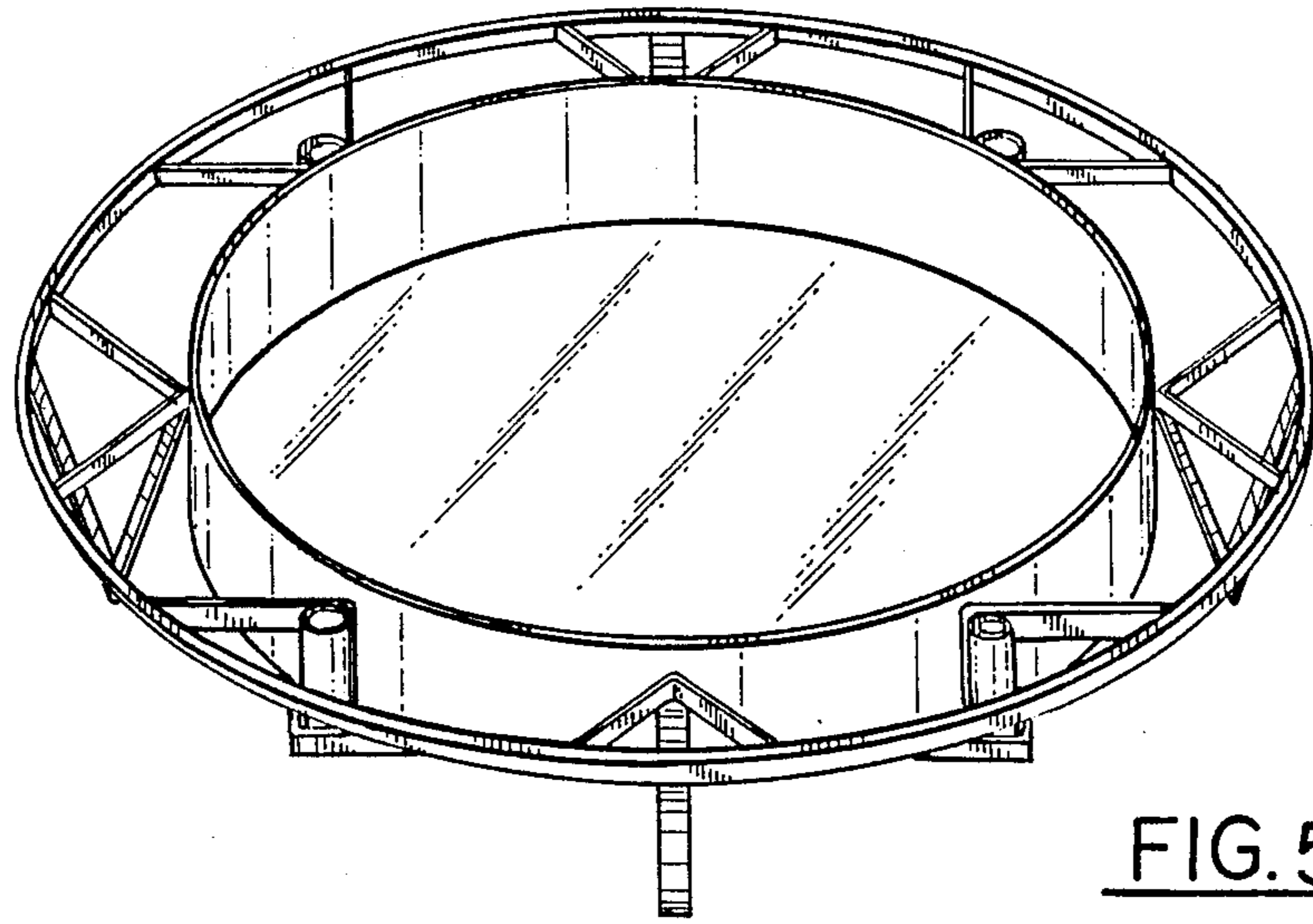

FIG. 5

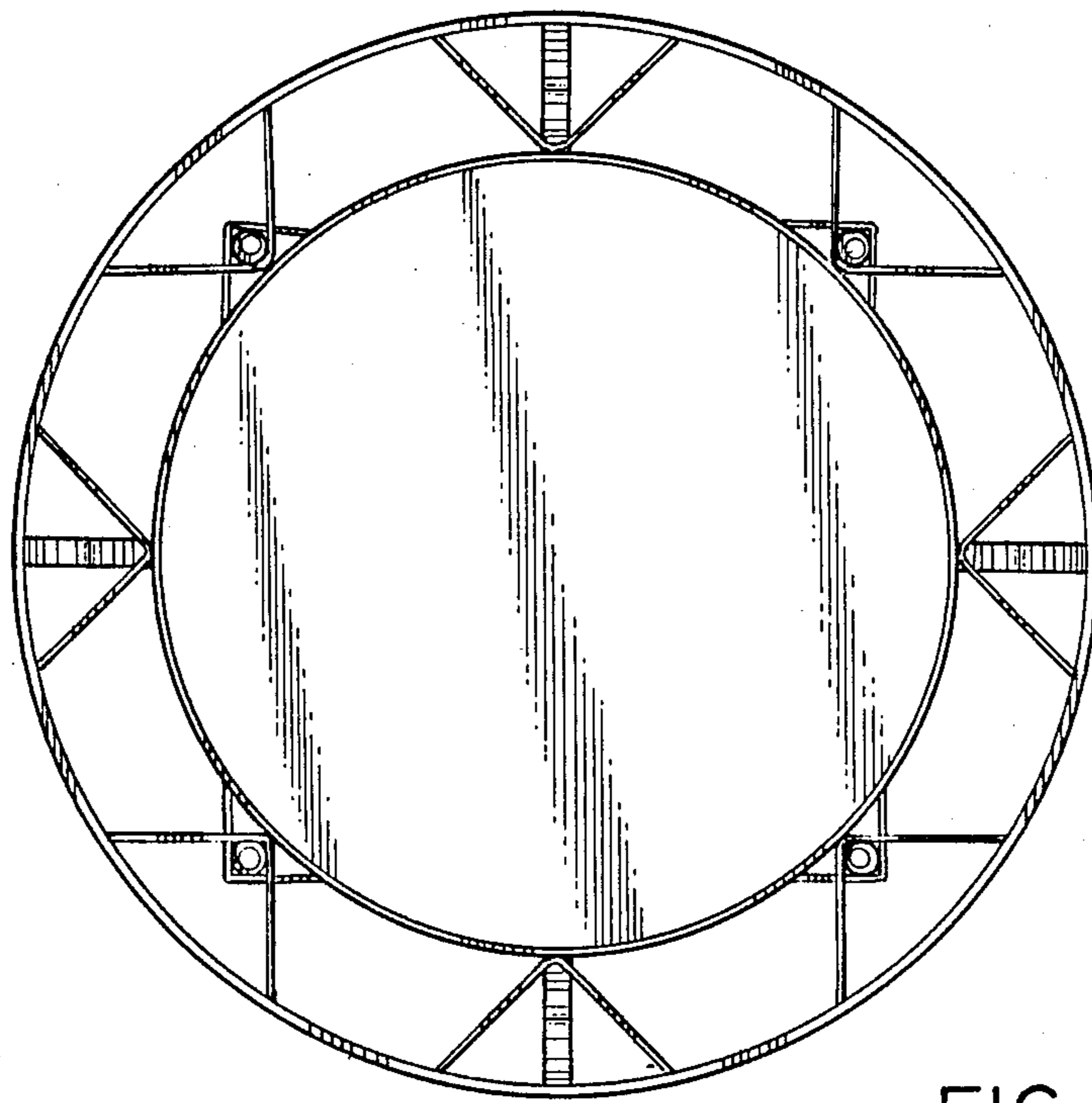

FIG. 2

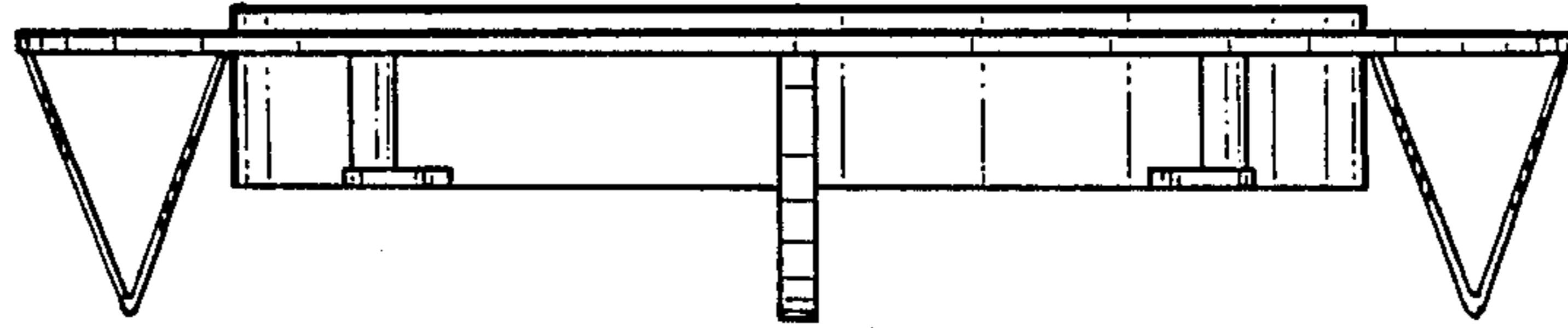

FIG. 3

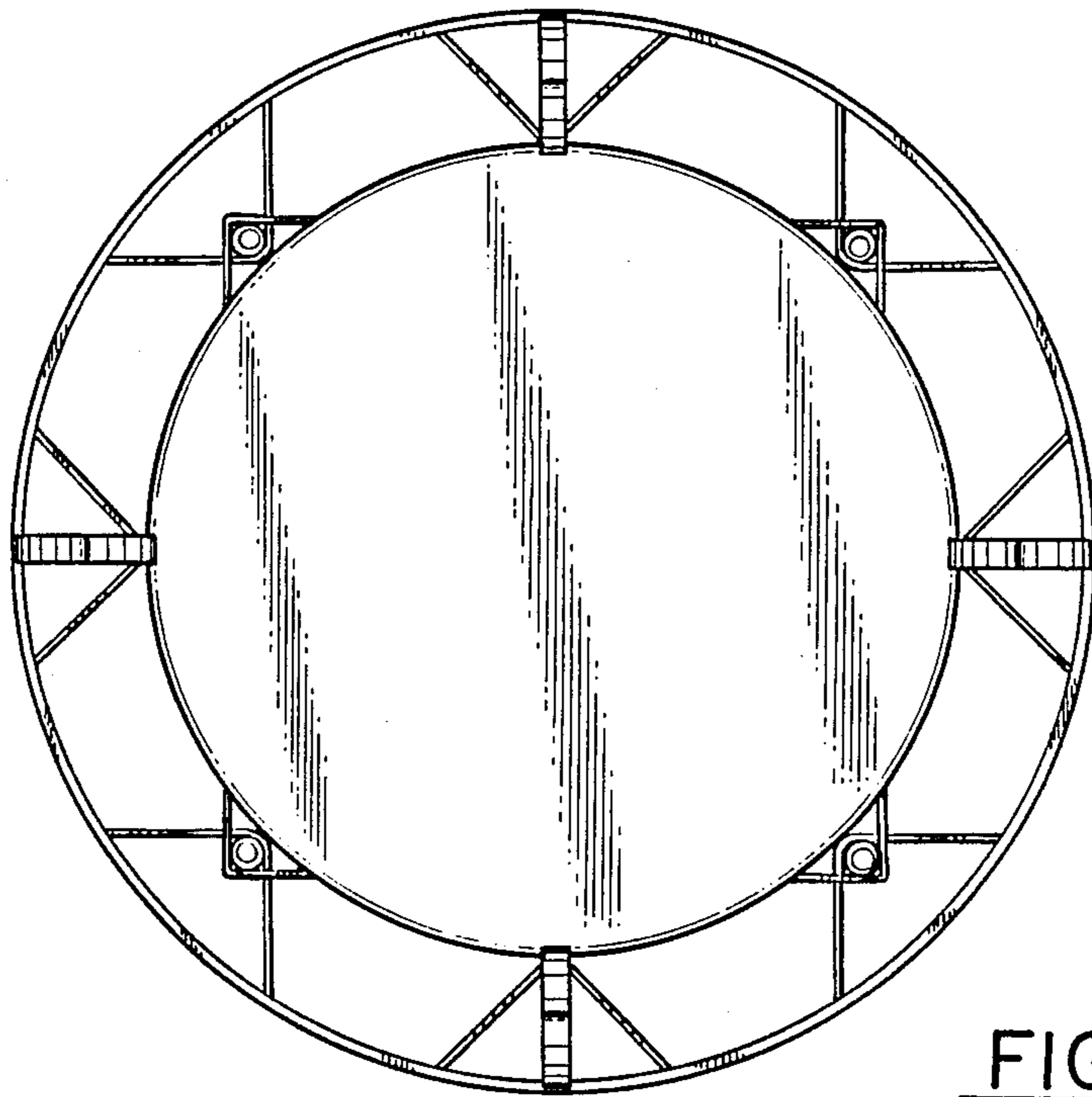

FIG. 4

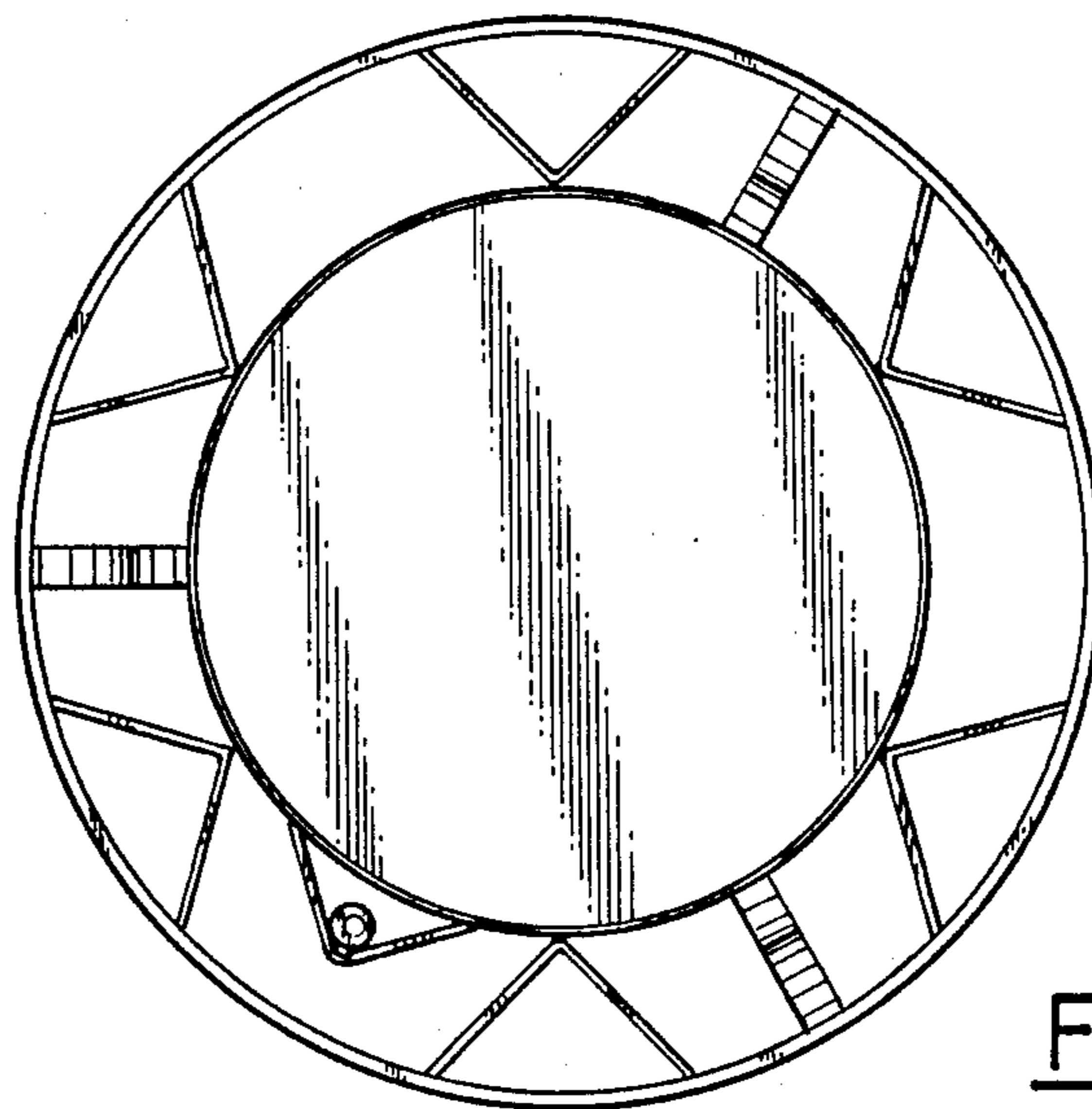

FIG. 8

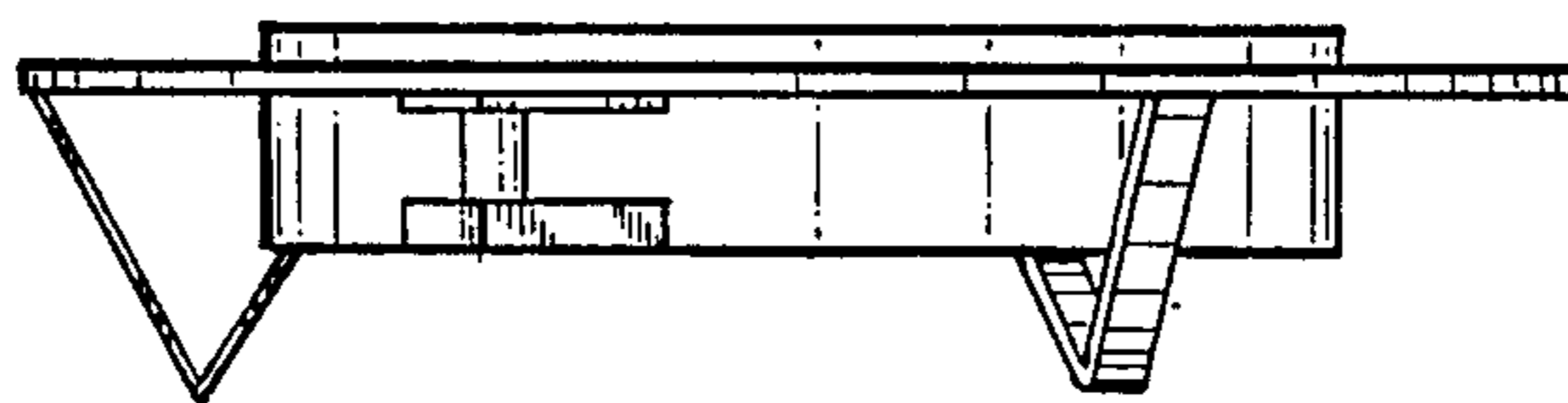

FIG. 9

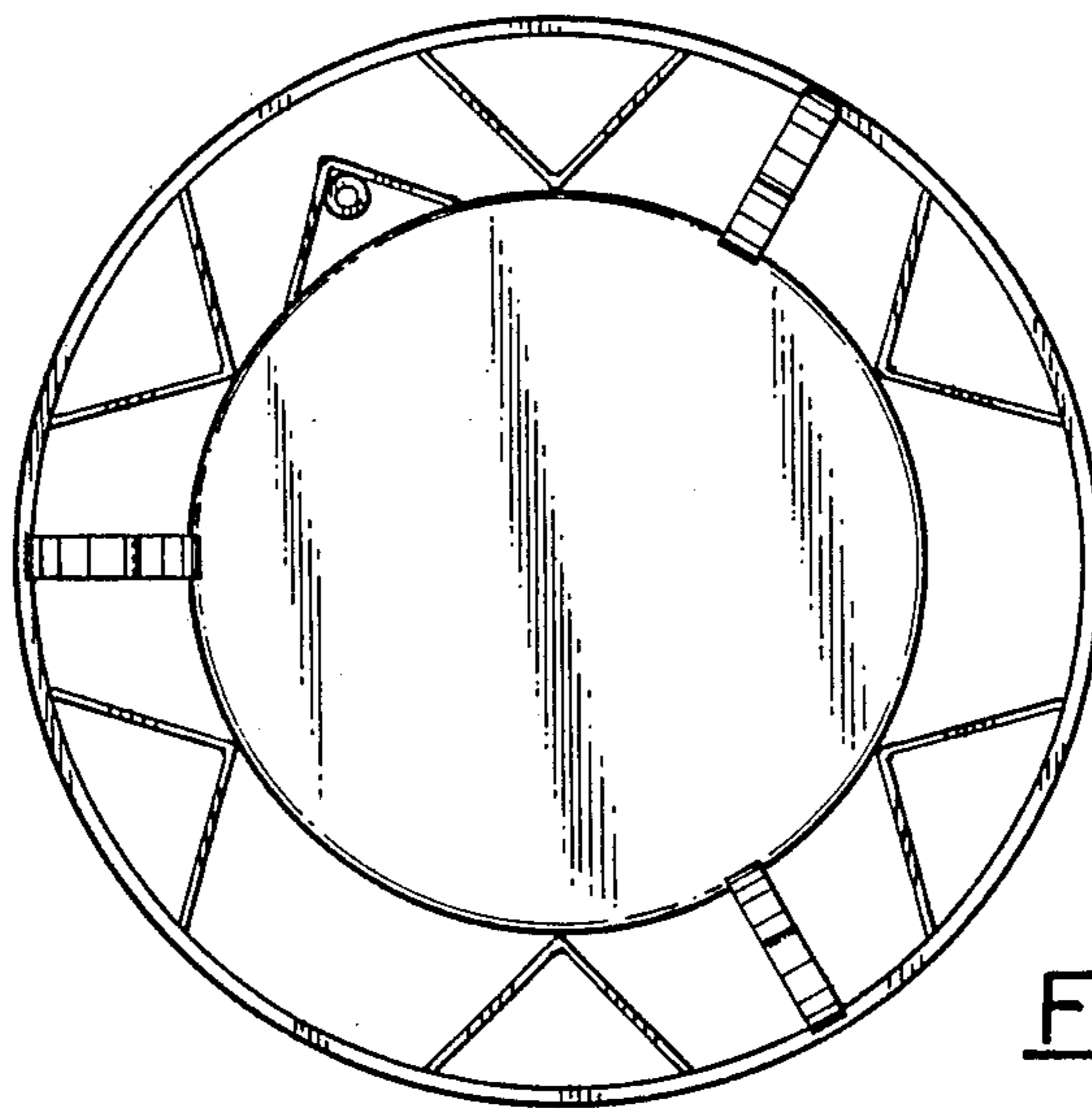

FIG. 10