

[54] **HINGE FOR REFRIGERATOR DOOR**
 [75] **Inventor: Tetsuo Takahashi, Tokyo, Japan**
 [73] **Assignee: Takigen Manufacturing Co., Ltd., Tokyo, Japan**
 [*] **Notice: The portion of the term of this patent subsequent to Jul. 11, 2003 has been disclaimed.**
 [**] **Term: 14 Years**
 [21] **Appl. No.: 899,598**
 [22] **Filed: Aug. 25, 1986**
 [52] **U.S. Cl. D8/329**
 [58] **Field of Search D8/323, 327, 329; 16/221, 247, 309, 312, 387**

D. 173,025 9/1954 Fritz D8/329
 2,208,310 7/1940 Leonard 16/312

OTHER PUBLICATIONS

Sweet's Architectural Catalog File; 1978; 11.23b/NO; p. 5; Cam-Lift Hinge.

Primary Examiner—B. J. Bullock
Attorney, Agent, or Firm—Martin Smolowitz

[57] **CLAIM**

The ornamental design for a hinge for refrigerator door, as shown.

DESCRIPTION

FIG. 1 is a front view of a hinge for refrigerator door showing my new design;
 FIG. 2 is a rear view thereof;
 FIG. 3 is a left side view thereof;
 FIG. 4 is a right side view thereof;
 FIG. 5 is a top view thereof;
 FIG. 6 is a bottom view thereof;
 FIG. 7 is a sectional view taken in the direction of the arrows on line 7—7 of FIG. 1.

- [56] **References Cited**
U.S. PATENT DOCUMENTS
 D. 80,617 3/1930 Graff D8/329
 D. 111,157 9/1938 Schrader D8/329
 D. 154,132 6/1949 Lounsbury D8/327
 D. 161,650 1/1951 Scovill D8/329

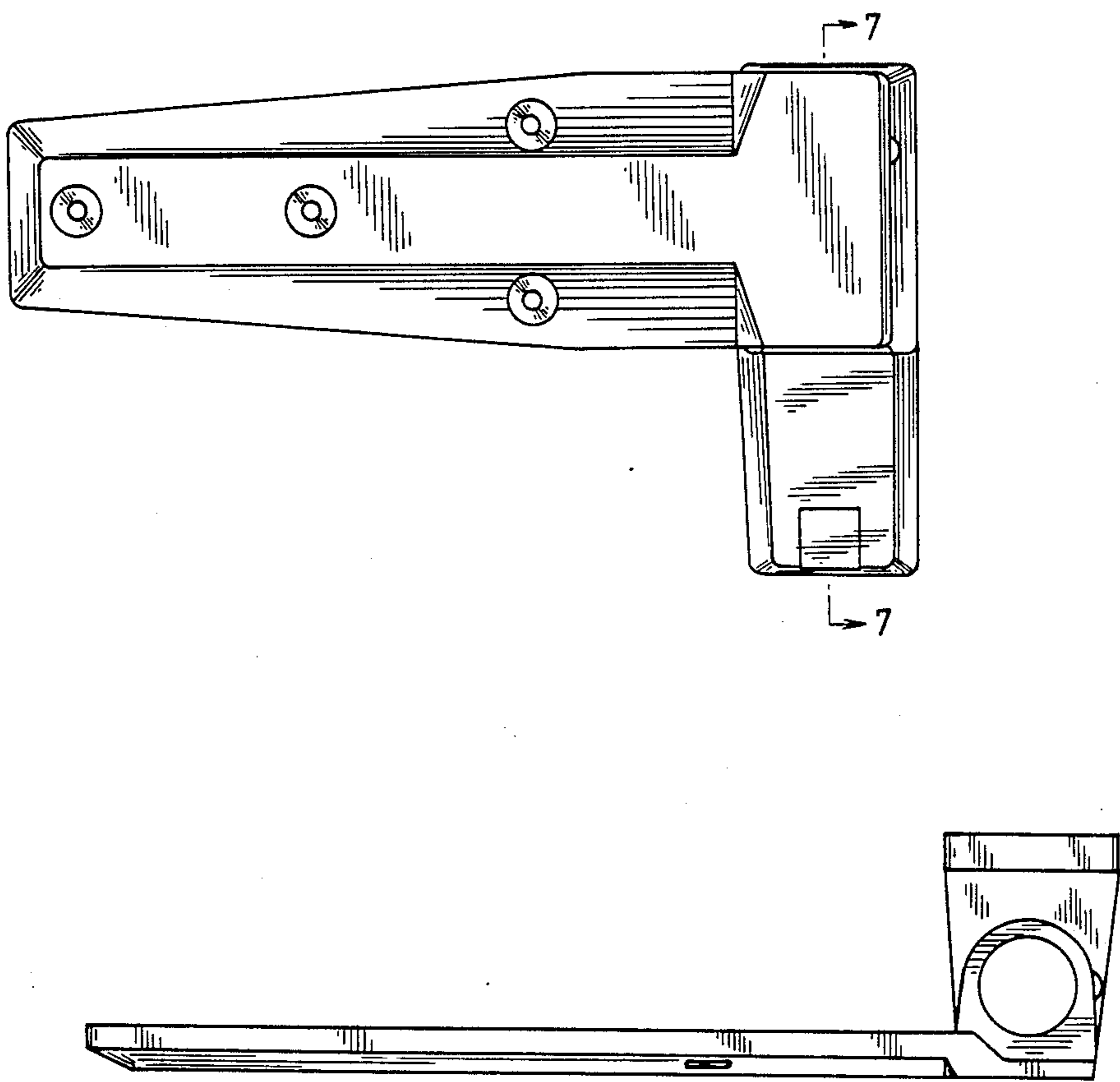

FIG. 1

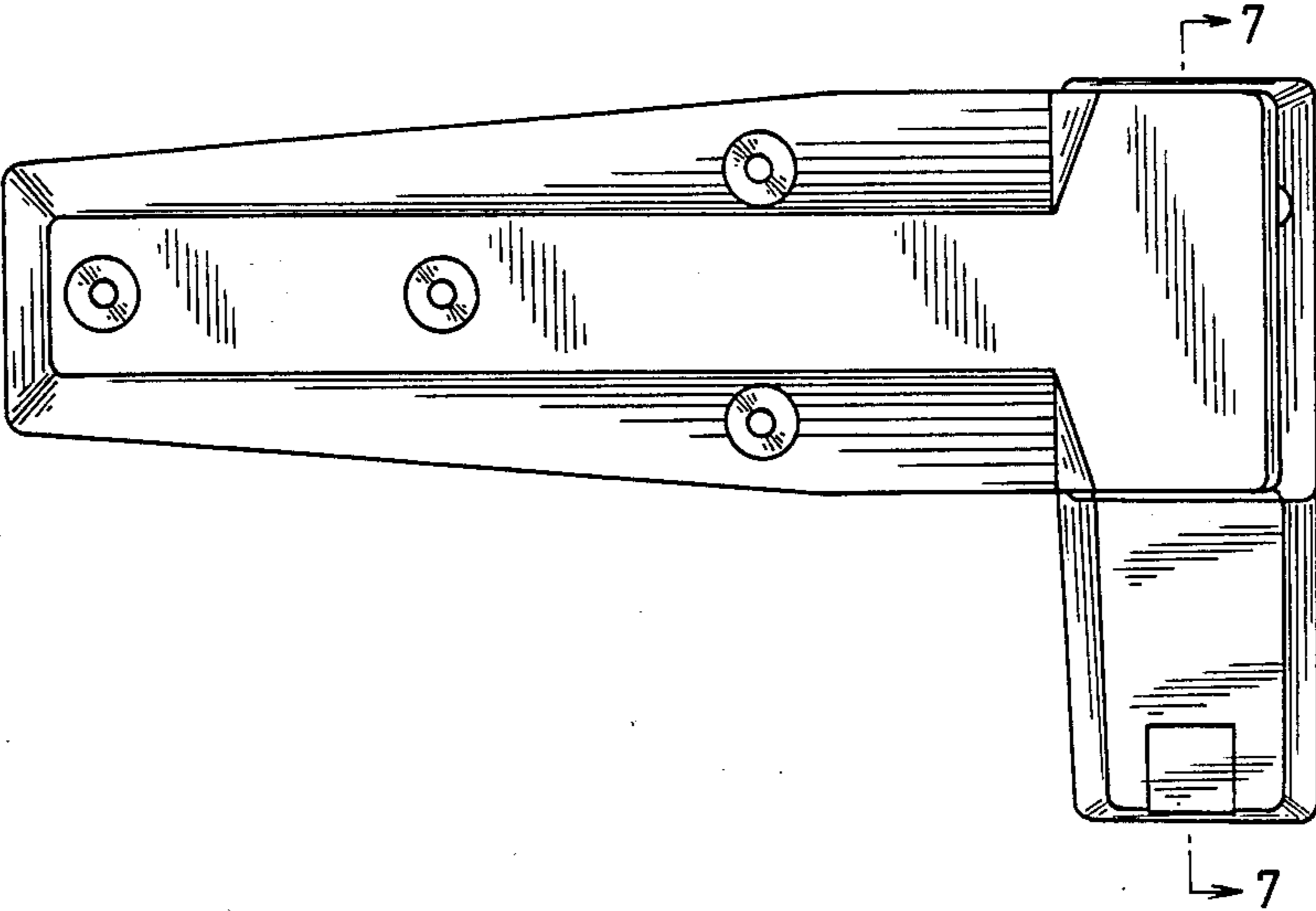

FIG. 2

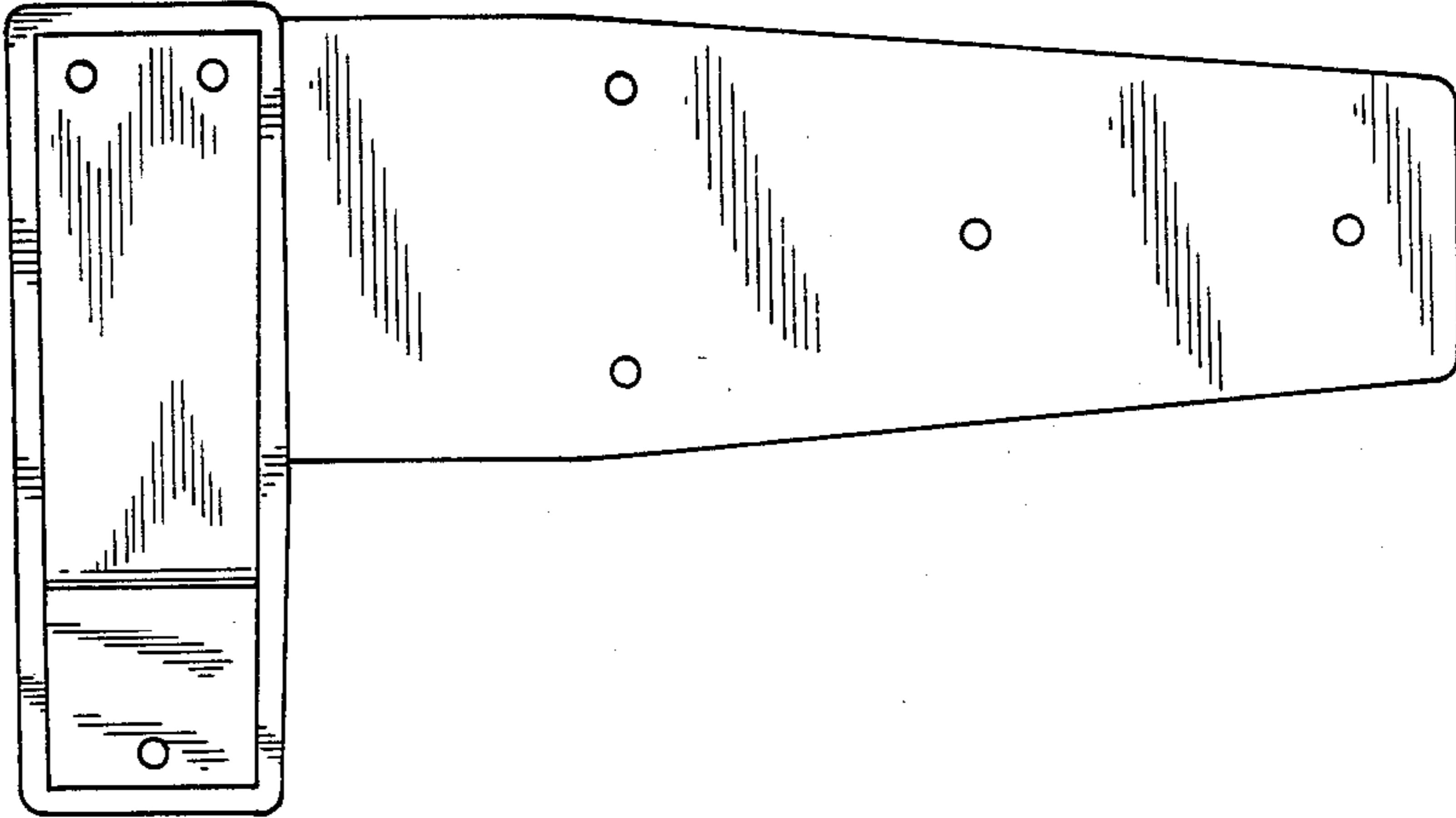

FIG. 5

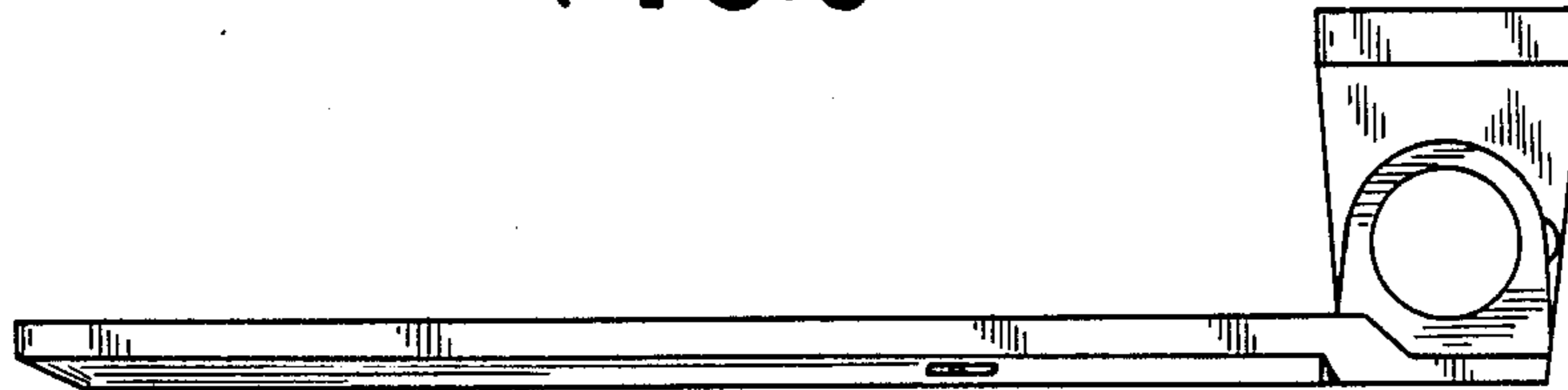

FIG. 6

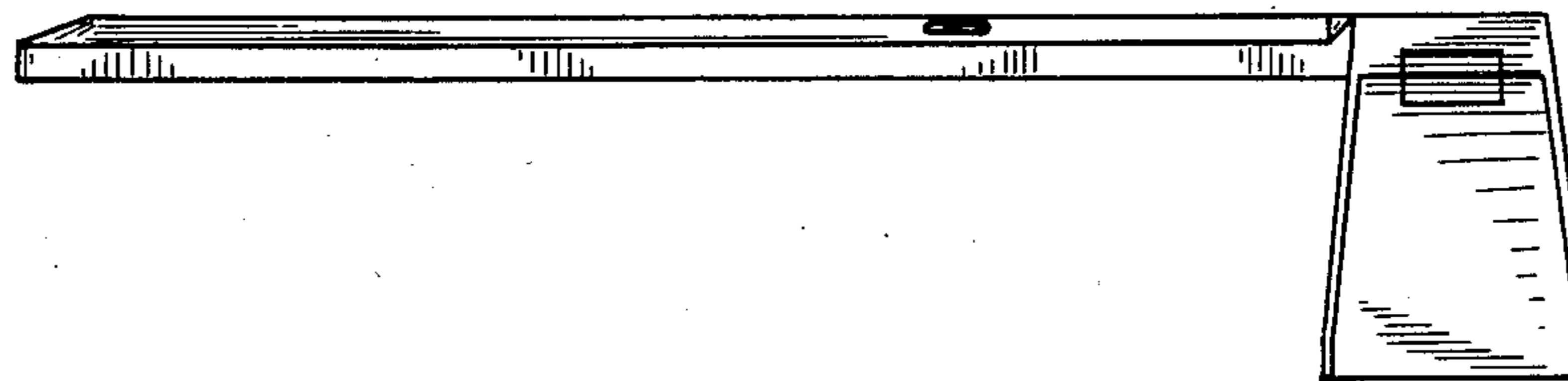

FIG. 3

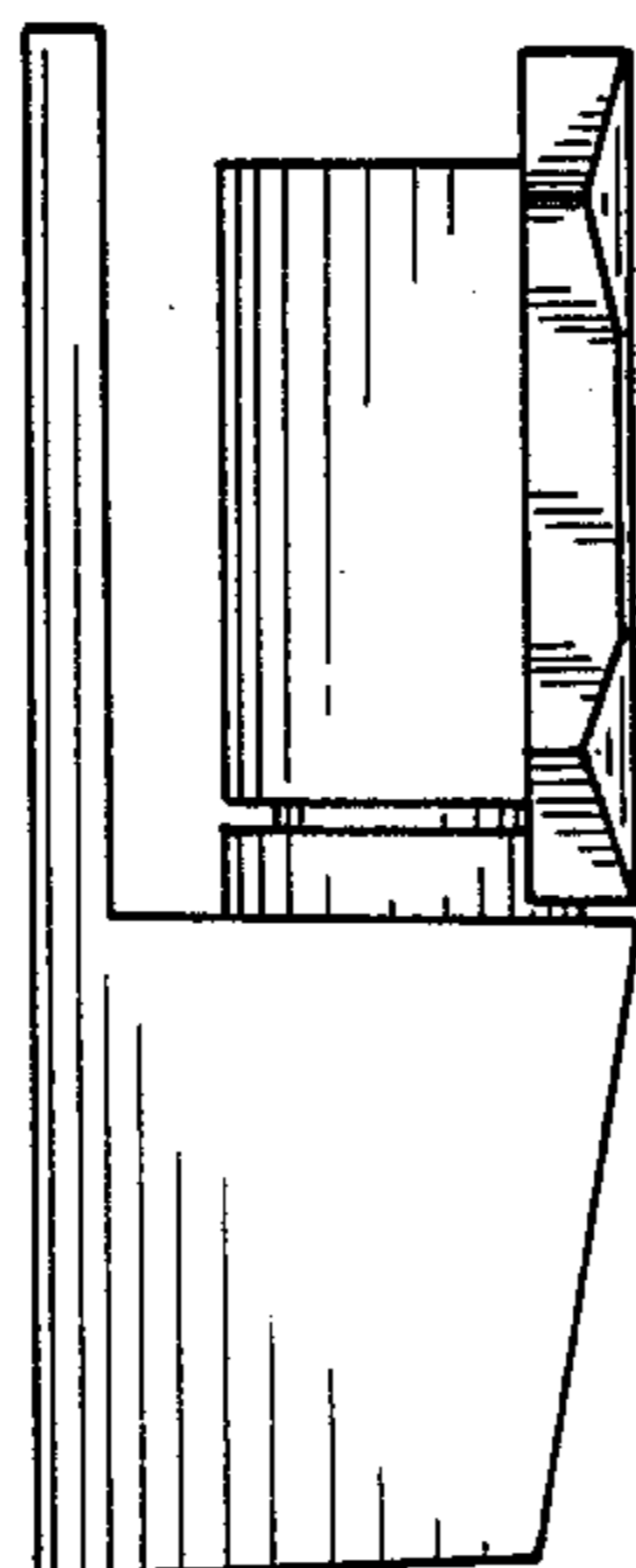

FIG. 4

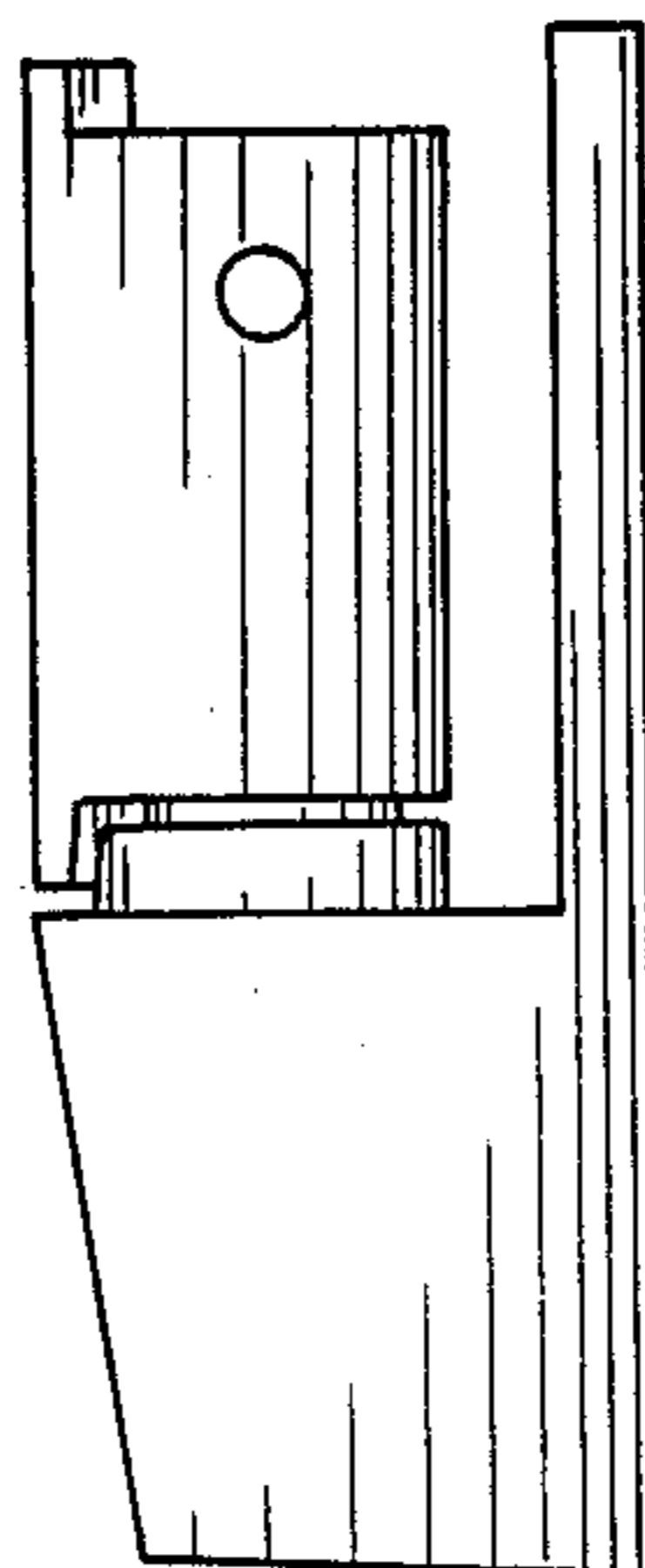

FIG. 7

