

[54] COMBINED HEARING AID BATTERY CARRIER, TESTER AND KEY RING

[76] Inventor: Egon F. Halasz, 2331 Ronde Vista Dr., Los Angeles, Calif. 90027

[**] Term: 14 Years

[21] Appl. No.: 806,625

[22] Filed: Dec. 9, 1985

[52] U.S. Cl. D3/62

[58] Field of Search D3/62, 61, 63-64; 70/456 R; D10/77

[56] References Cited

U.S. PATENT DOCUMENTS

- D. 214,088 5/1969 Bellafore D10/77
- D. 285,987 10/1986 MacDonald D3/61
- 2,611,260 9/1952 Pontin 70/456 R

Primary Examiner—Bernard Ansher

Assistant Examiner—Terry Pfeffer

Attorney, Agent, or Firm—John E. Wagner

[57] CLAIM

The ornamental design for a combined hearing aid bat-

tery carrier, tester and key ring, as shown and described.

DESCRIPTION

FIG. 1 is a front perspective view of a combined hearing aid battery carrier, tester and key ring showing my new design;

FIG. 2 is a front elevational view thereof;

FIG. 3 is a rear elevational view thereof;

FIG. 4 is an end elevational view thereof;

FIG. 5 is an elevational view of the opposite end thereof;

FIG. 6 is a side elevational view thereof;

FIG. 7 is an elevational view of the opposite side thereof;

FIG. 8 is a front elevational view thereof in an open condition;

FIG. 9 is a rear elevational view in an opened condition;

FIG. 10 is a right end side elevational view thereof in an open condition;

FIG. 11 is a left end elevational view thereof;

FIG. 12 is a side elevational view in an opened condition; and

FIG. 13 is the opposite side elevational view thereof.

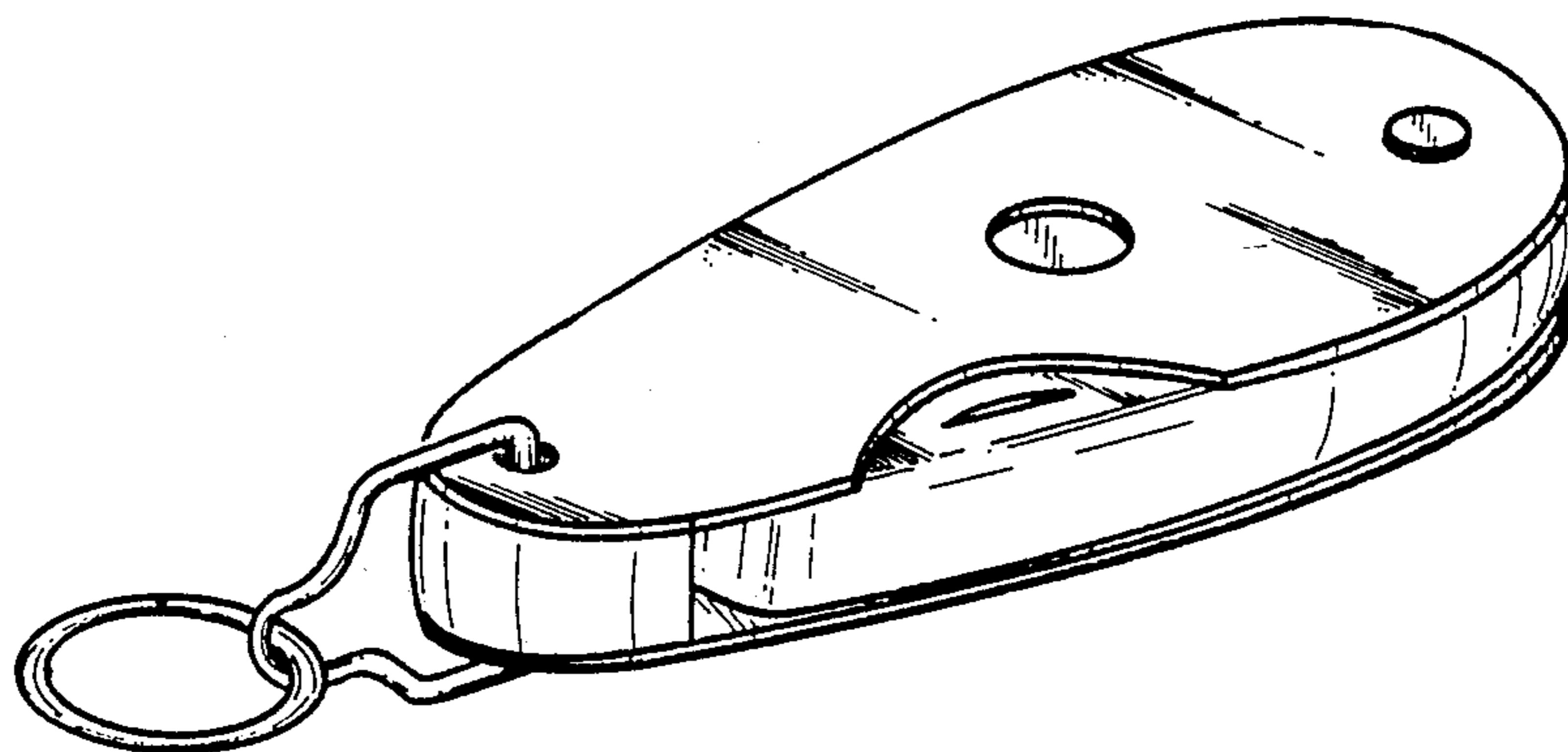

Fig. 1

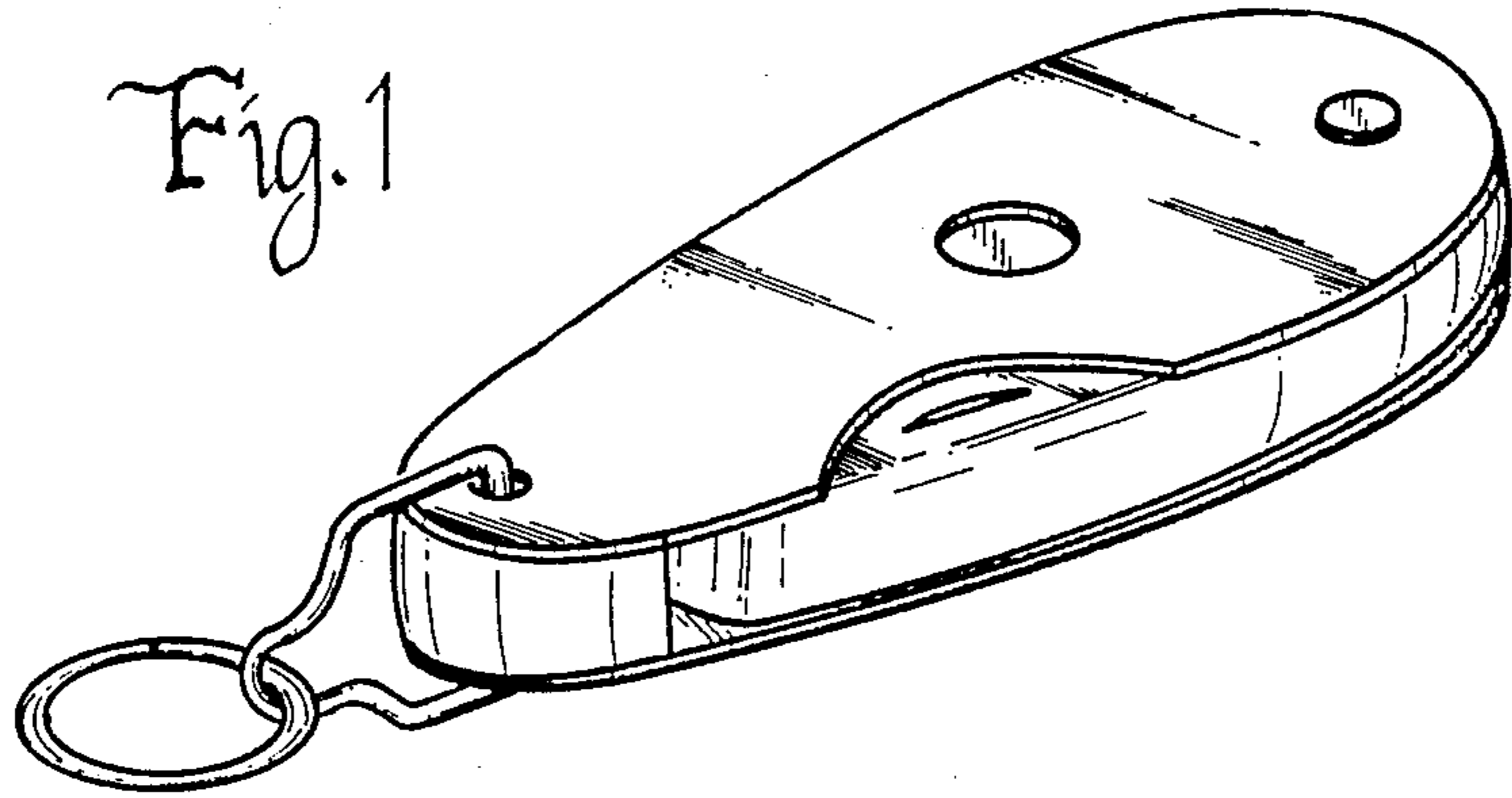

Fig. 2

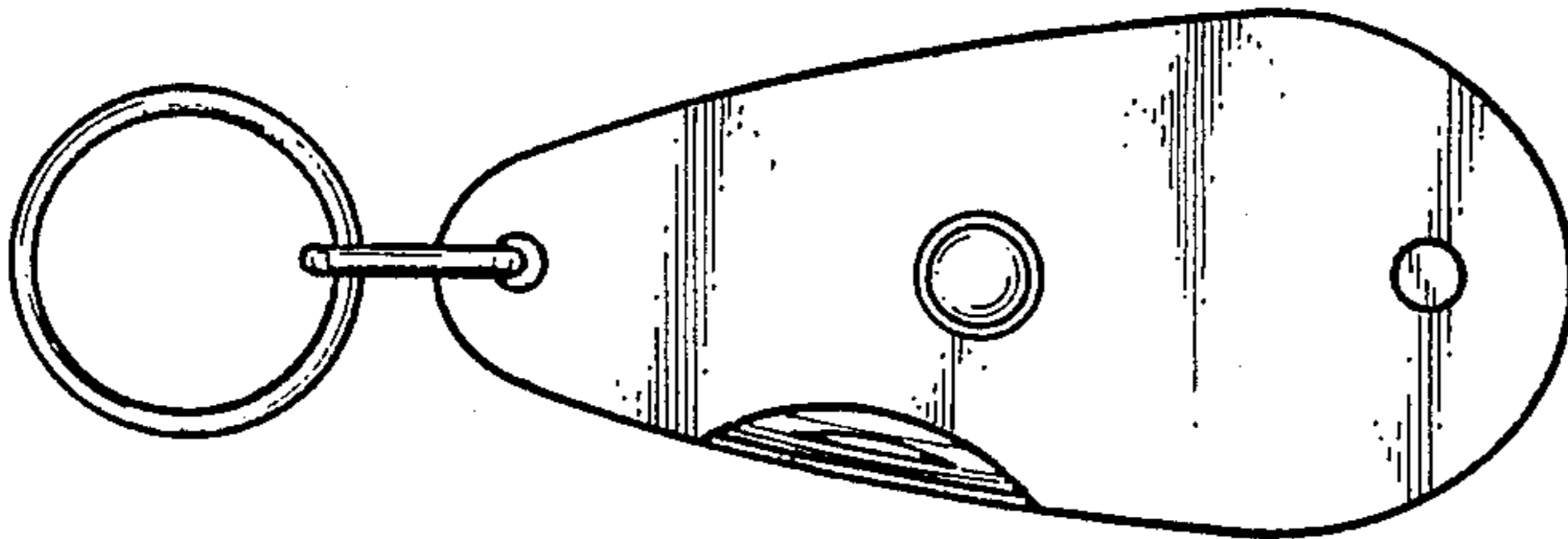

Fig. 3

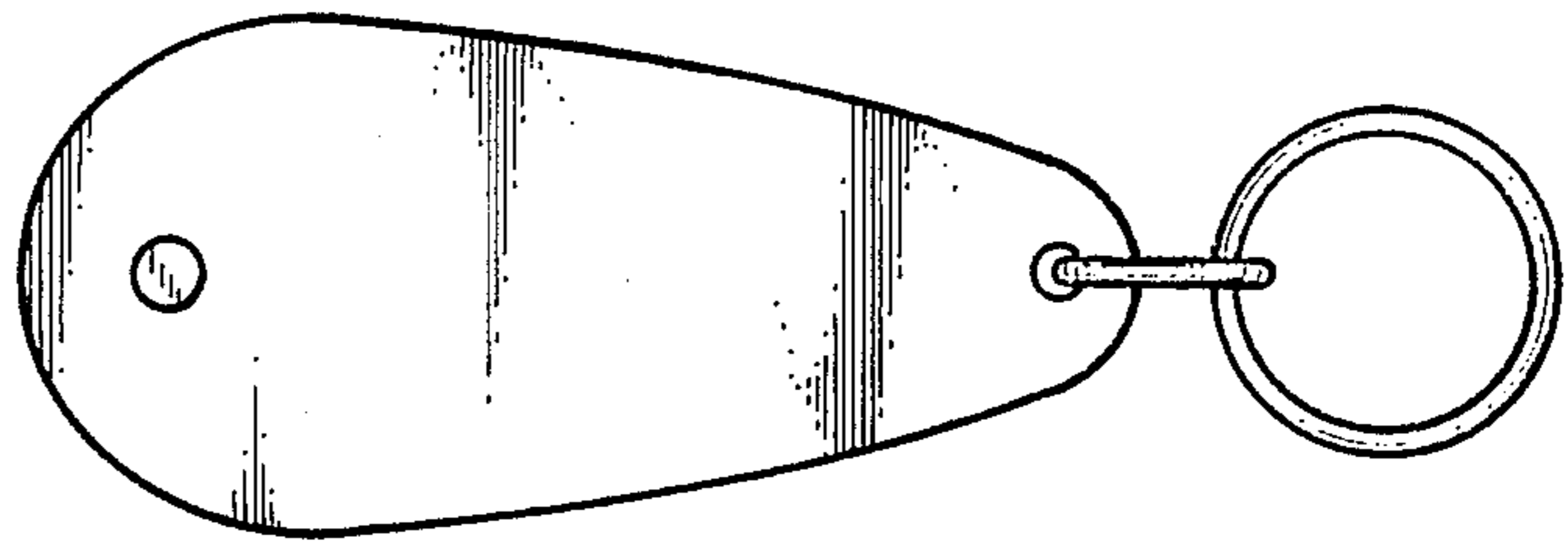

Fig. 6



Fig. 4

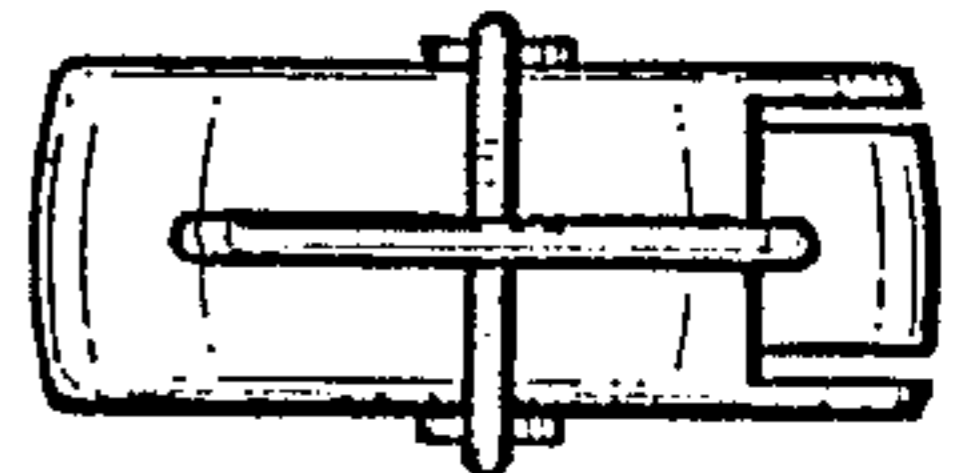

Fig. 7

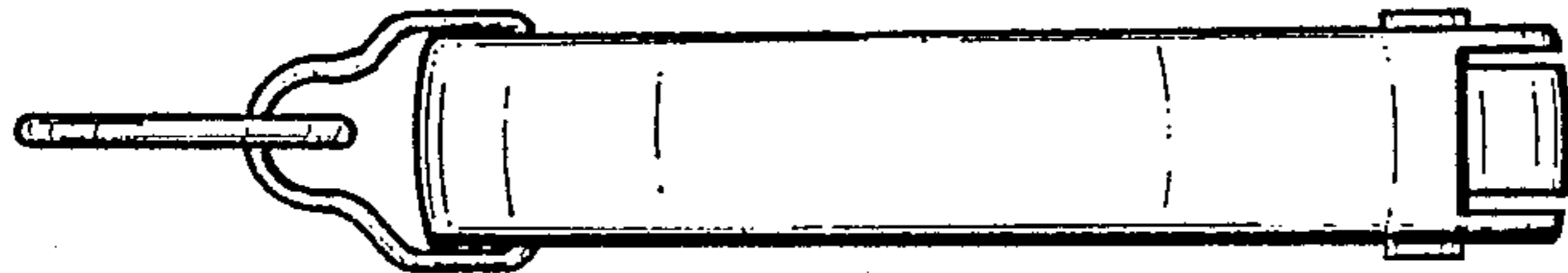

Fig. 5

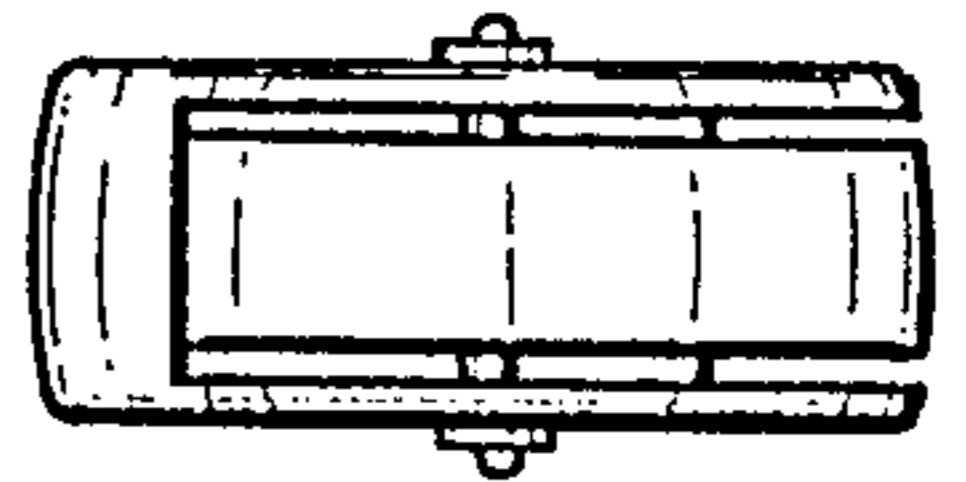

Fig. 8

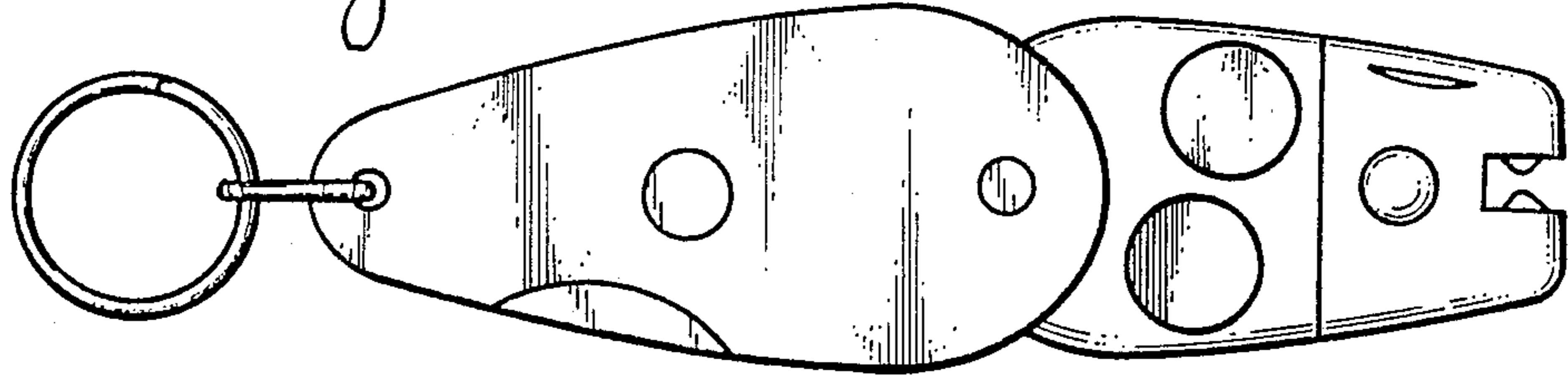

Fig. 9

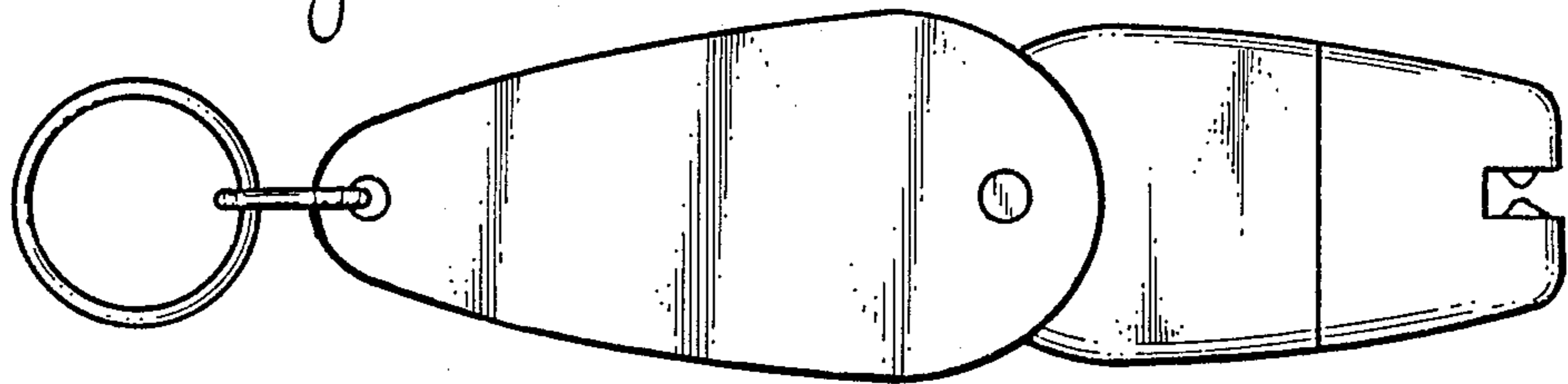

Fig. 11

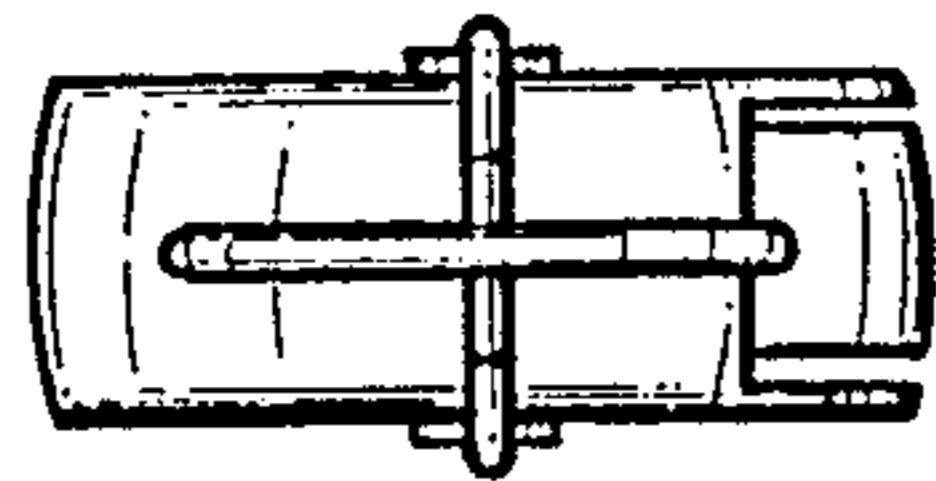

Fig. 10

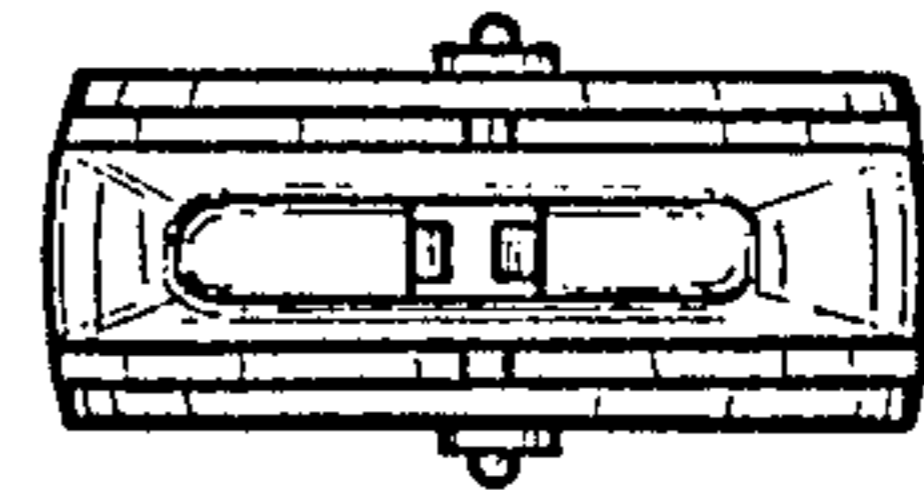

Fig. 12

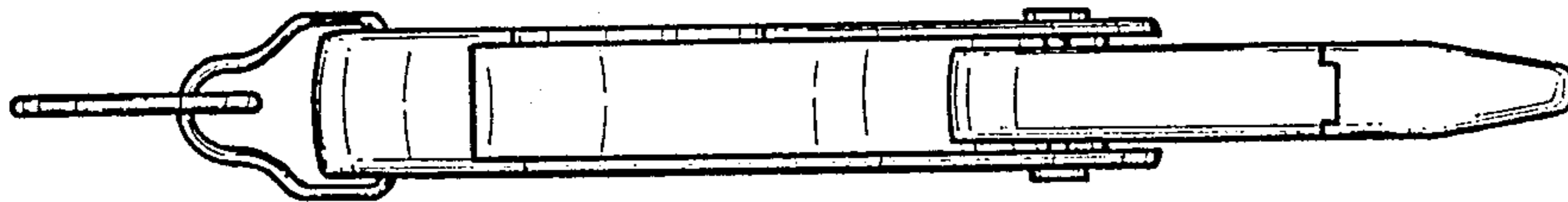
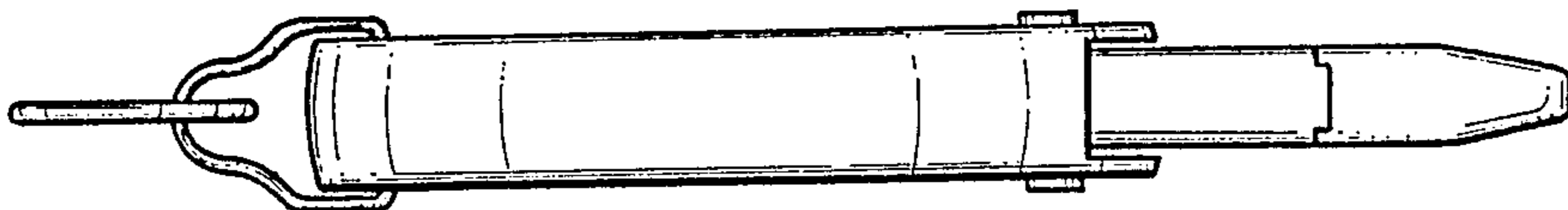

Fig. 13



UNITED STATES PATENT AND TRADEMARK OFFICE
CERTIFICATE OF CORRECTION

PATENT NO. : Des. 302,074
DATED : July 11, 1989
INVENTOR(S) : Egon F. Halasz

It is certified that error appears in the above-identified patent and that said Letters Patent is hereby corrected as shown below:

On the title page :

The address of the inventor is changed to:

2331 Ronda Vista Dr.
Los Angeles, CA 90027

**Signed and Sealed this
Twenty-second Day of May, 1990**

Attest:

Attesting Officer

HARRY F. MANBECK, JR.

Commissioner of Patents and Trademarks