

United States Patent [19]

Williams, Jr.

[11] Patent Number: **Des. 302,016**

[45] Date of Patent: **** Jul. 4, 1989**

[54] **COVER FOR A TELEPHONE HANDSET**

[76] Inventor: **Alphonso F. Williams, Jr., 100-15F
Erskine Pl., Bronx, N.Y. 10475**

[**] Term: **14 Years**

[21] Appl. No.: **117,139**

[22] Filed: **Nov. 5, 1987**

[52] U.S. Cl. **D14/250; D14/209**

[58] Field of Search **D14/59, 67; 379/423,
379/452; D24/49**

[56] **References Cited**

U.S. PATENT DOCUMENTS

D. 45,347	3/1914	Mundt	D14/67
D. 109,316	4/1938	Eighmey	D14/67
D. 151,809	11/1948	Dreyfus	D14/67 X
D. 209,909	1/1968	Price	D14/59
D. 210,953	5/1968	Youngberg	D14/59
D. 211,355	6/1968	Farnham et al.	D14/59
D. 214,322	6/1969	Valasquez	D14/59
D. 217,059	3/1970	Todeschini	D14/59
D. 233,633	11/1974	Burkard	D24/49 X
D. 239,058	3/1976	Gaylord, Jr.	D24/49
1,340,661	5/1920	Lobl	D14/67 X
1,578,165	3/1926	Mullen	379/452
2,313,383	3/1943	Kolodny	379/452

3,397,696	8/1968	Richard	D24/49 X
4,570,038	2/1986	Tinelli	379/452
4,633,044	12/1986	Nakajima	379/433
4,736,418	4/1988	Steadman	379/433

FOREIGN PATENT DOCUMENTS

2528676	1/1977	Fed. Rep. of Germany	379/452
2572607	10/1984	France	379/452

OTHER PUBLICATIONS

1979 Catalog of Figi's Inc. at pp. 48, 49; showing of Fabric Caps on Preserves & Honey.

Primary Examiner—Horace B. Fay, Jr.

Attorney, Agent, or Firm—Rodman & Rodman

[57] **CLAIM**

The ornamental design for a cover for a telephone handset, substantially as shown and described.

DESCRIPTION

FIG. 1 is a right side perspective side of a cover for a telephone handset showing my new design; FIG. 2 is a left side elevational view thereof, the right side elevational view being a mirror image; FIGS. 3 and 4 are respectively top and bottom plan views thereof; and, FIG. 5 is an end view thereof, the opposite end being a mirror image.

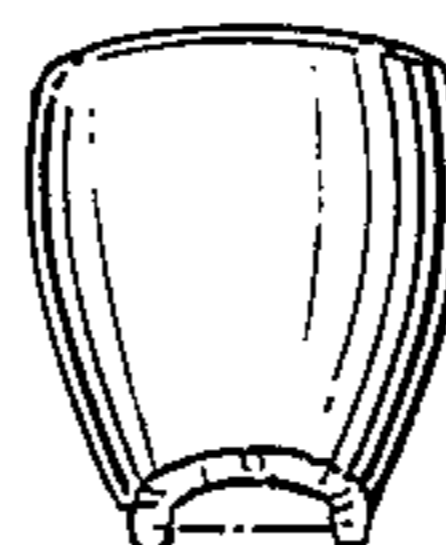
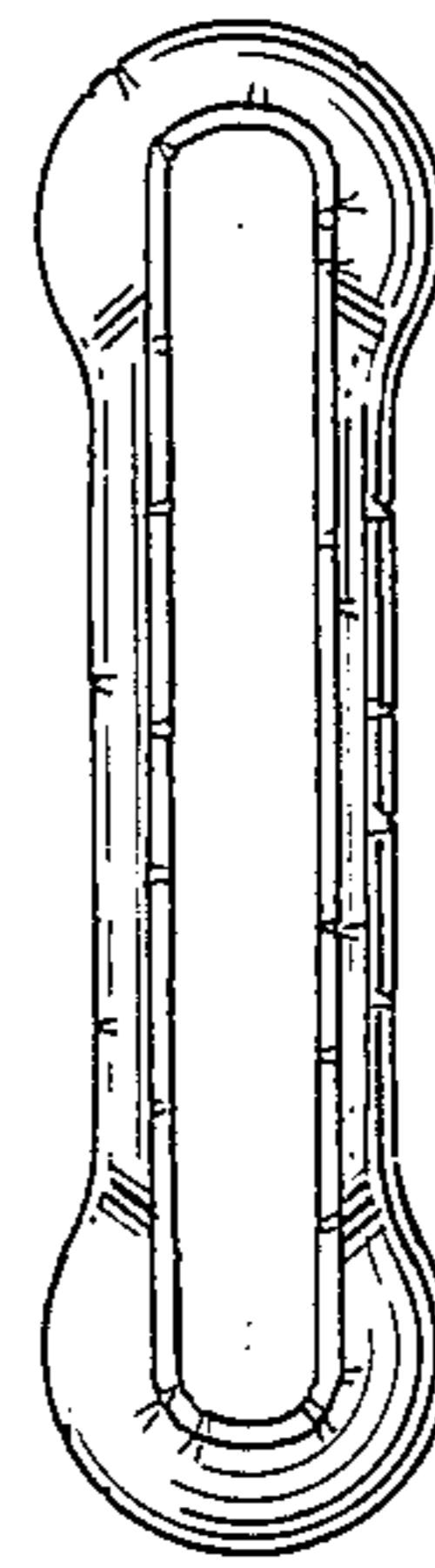
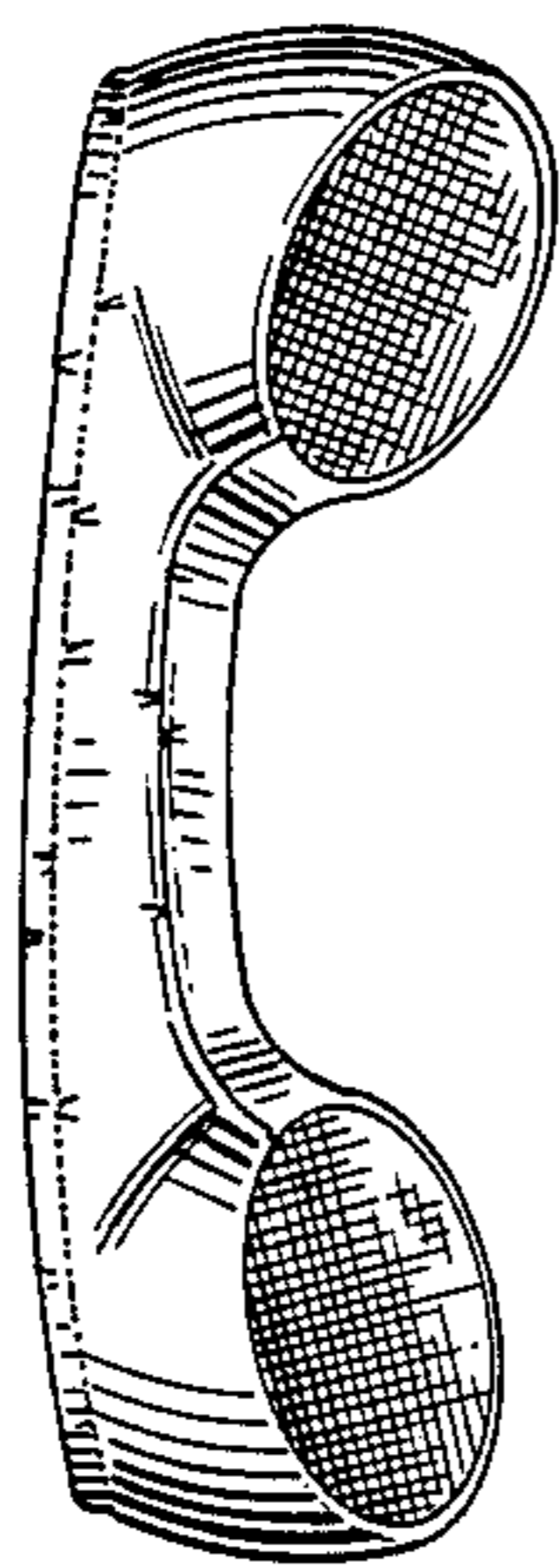

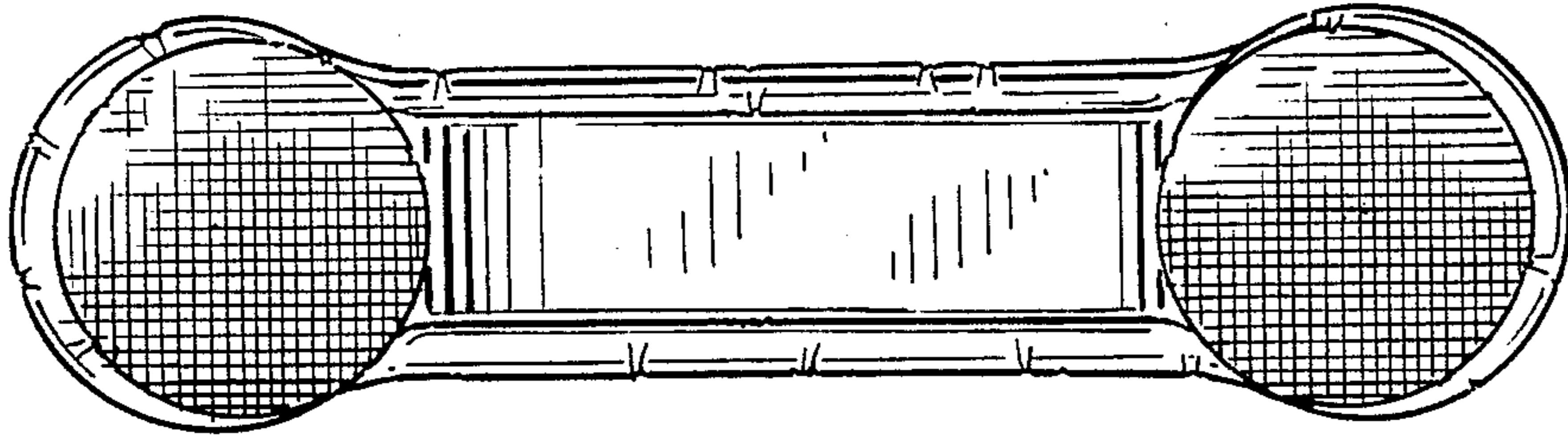

Fig. 4.

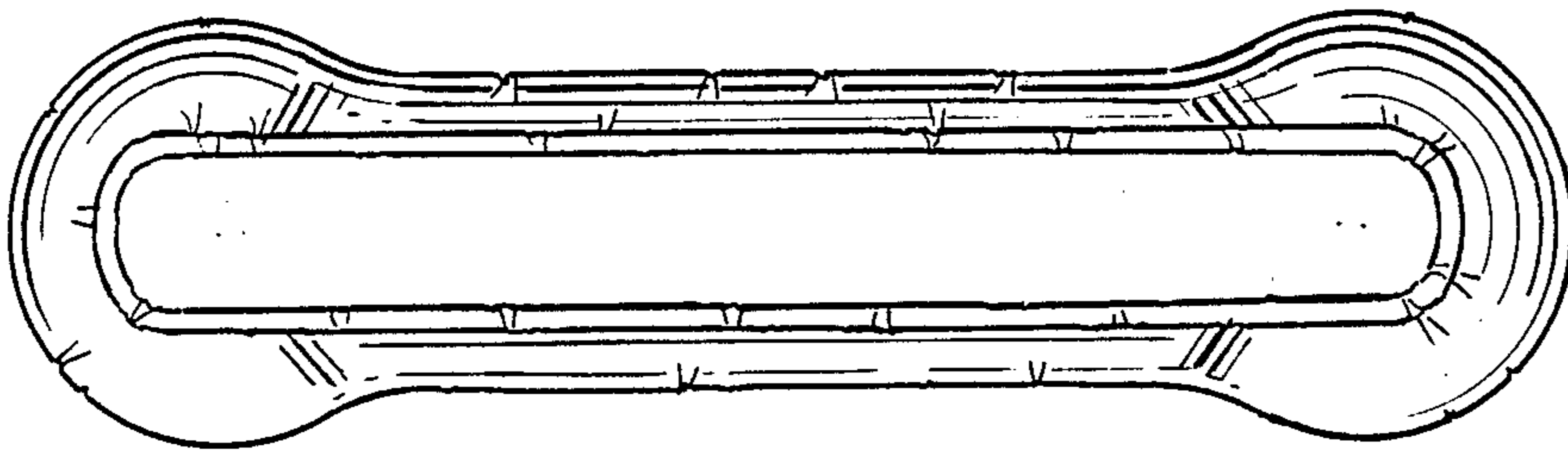

Fig. 3.

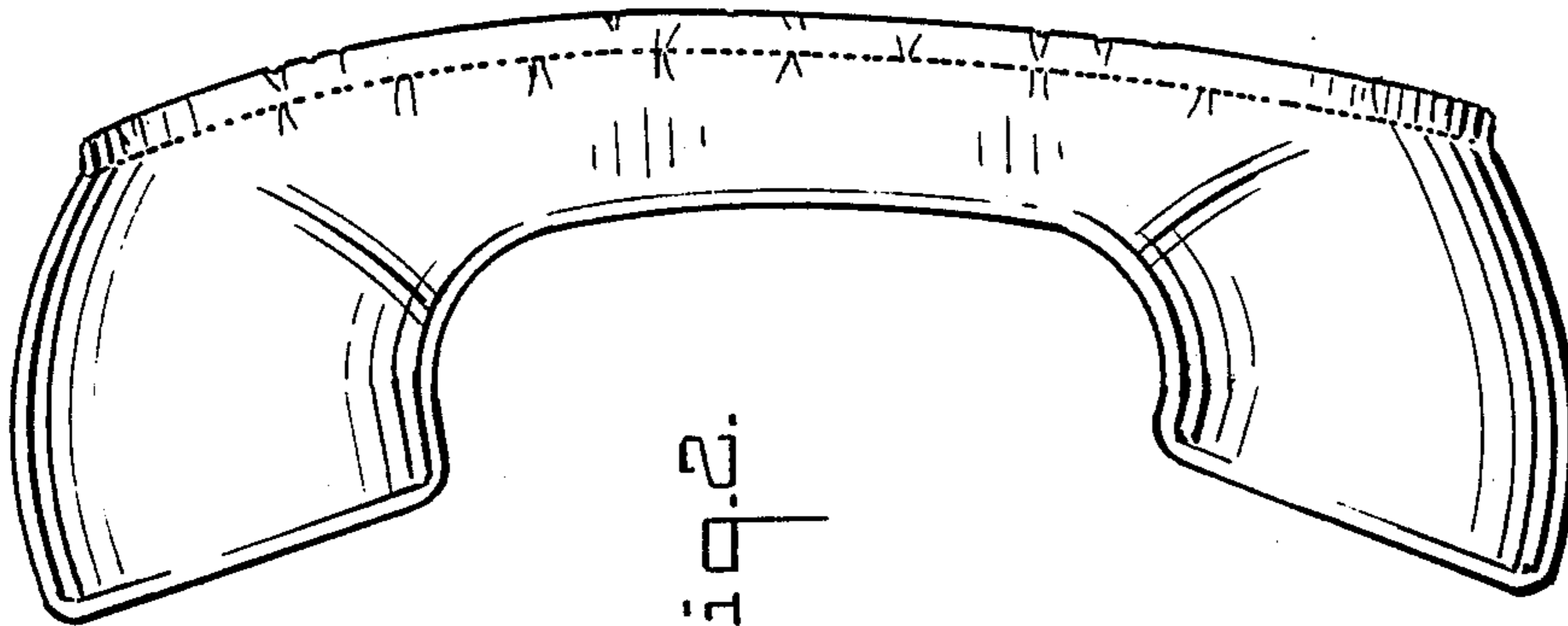

Fig. 2.

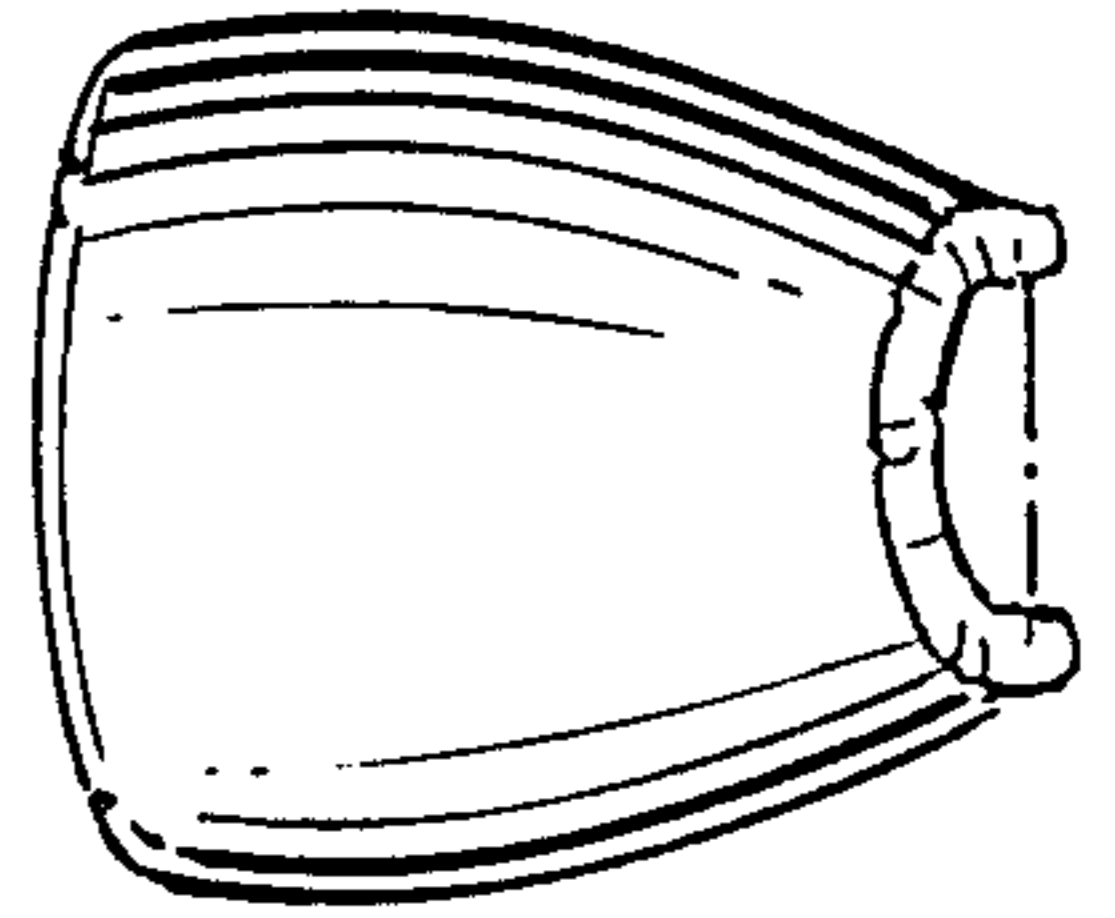

Fig. 5.

D17

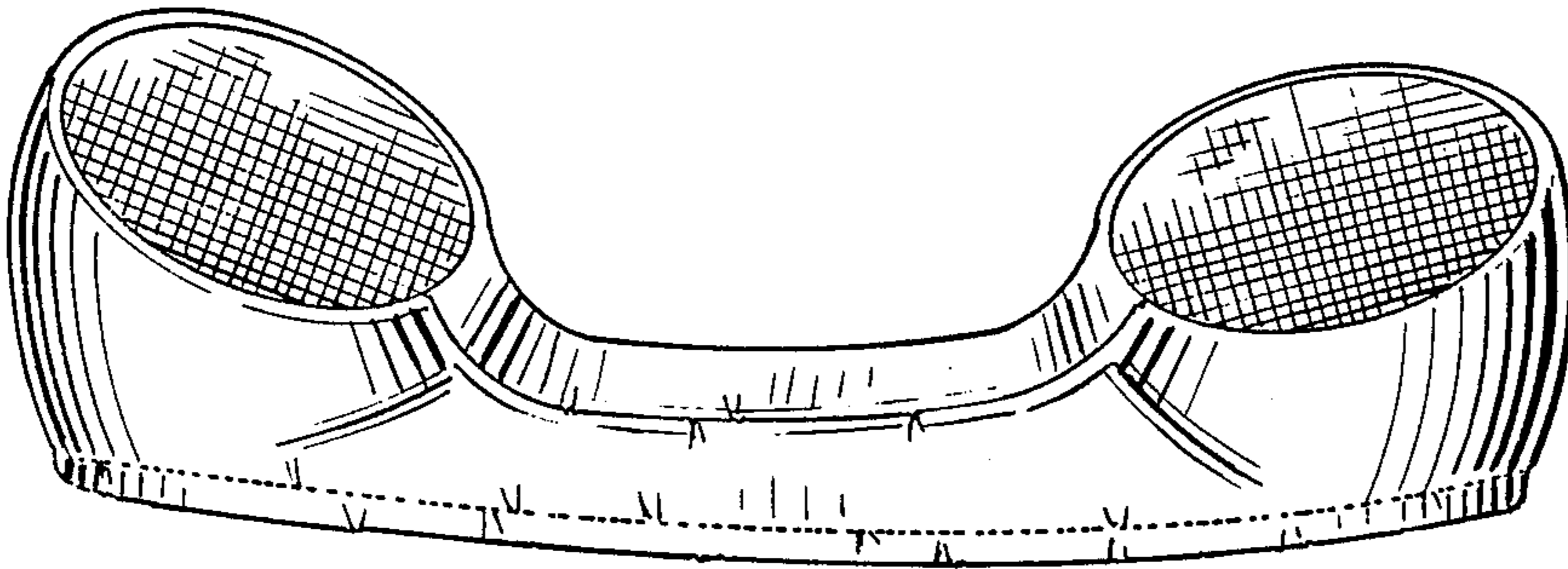

Fig. 1.

D14

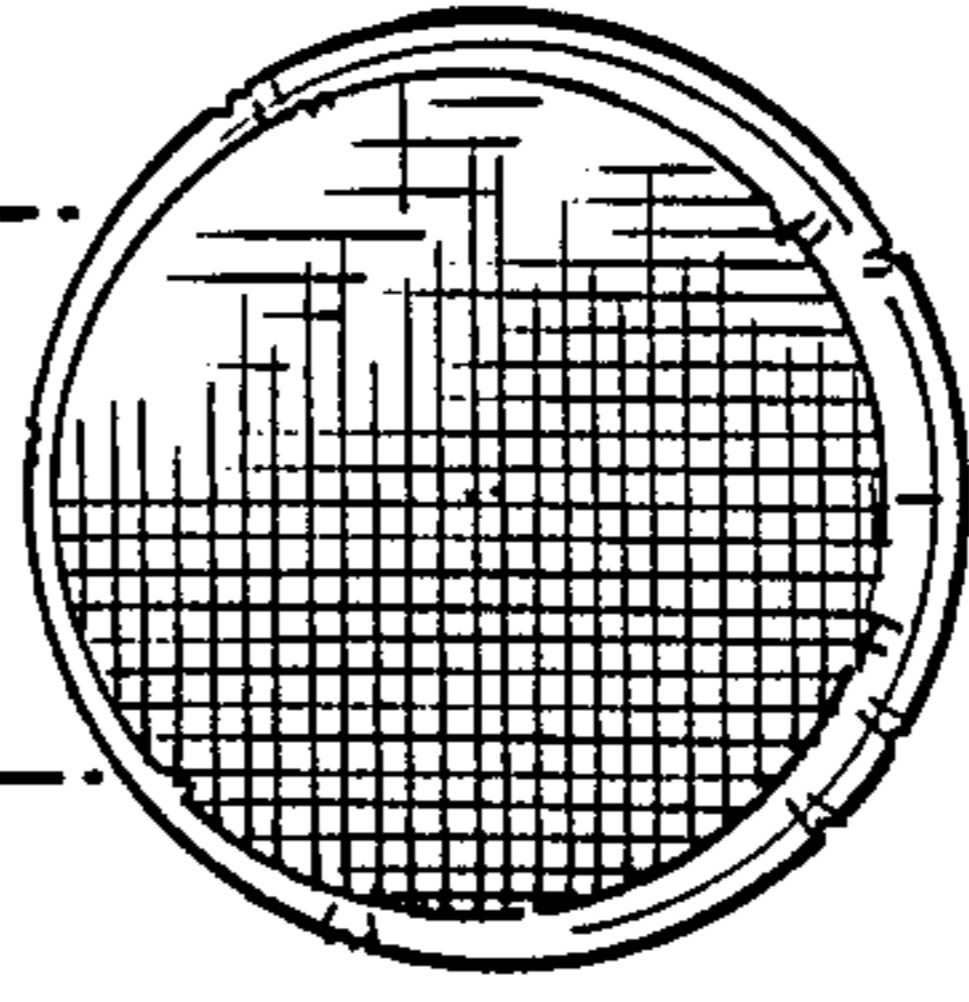
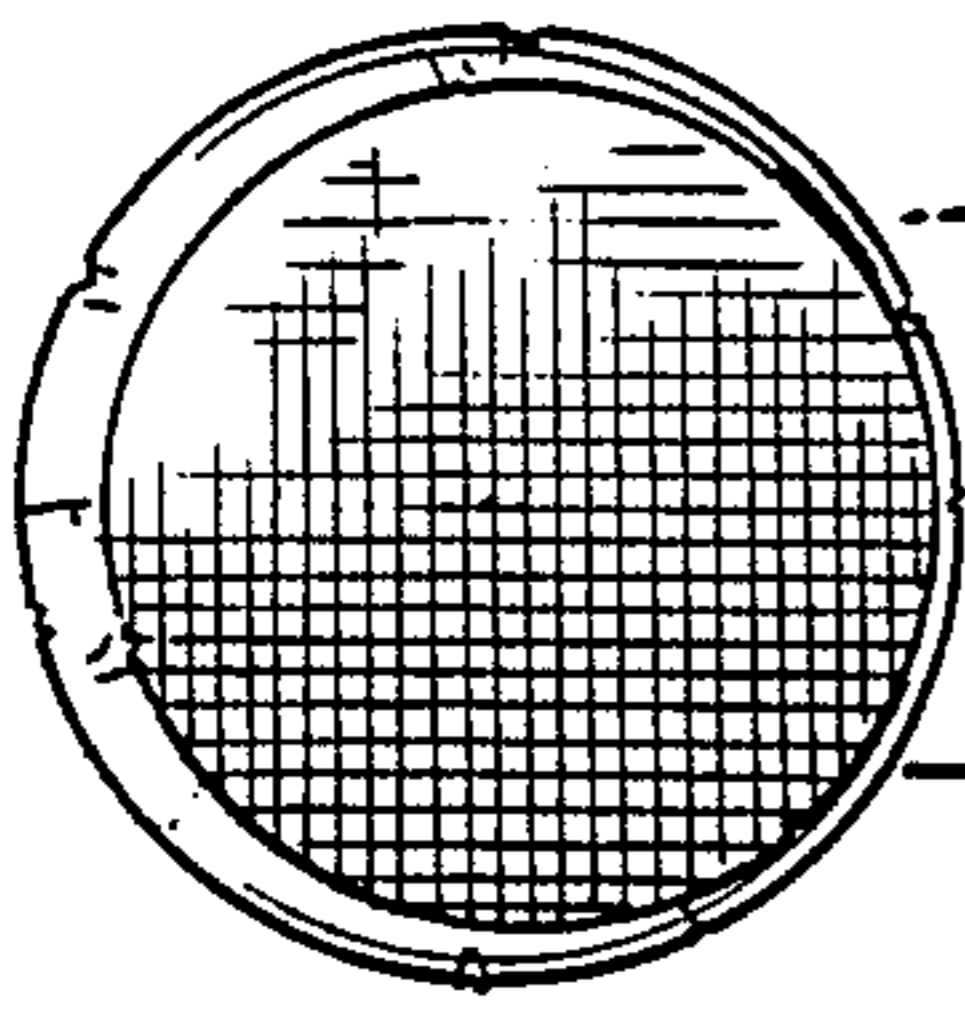

Fig. 9.

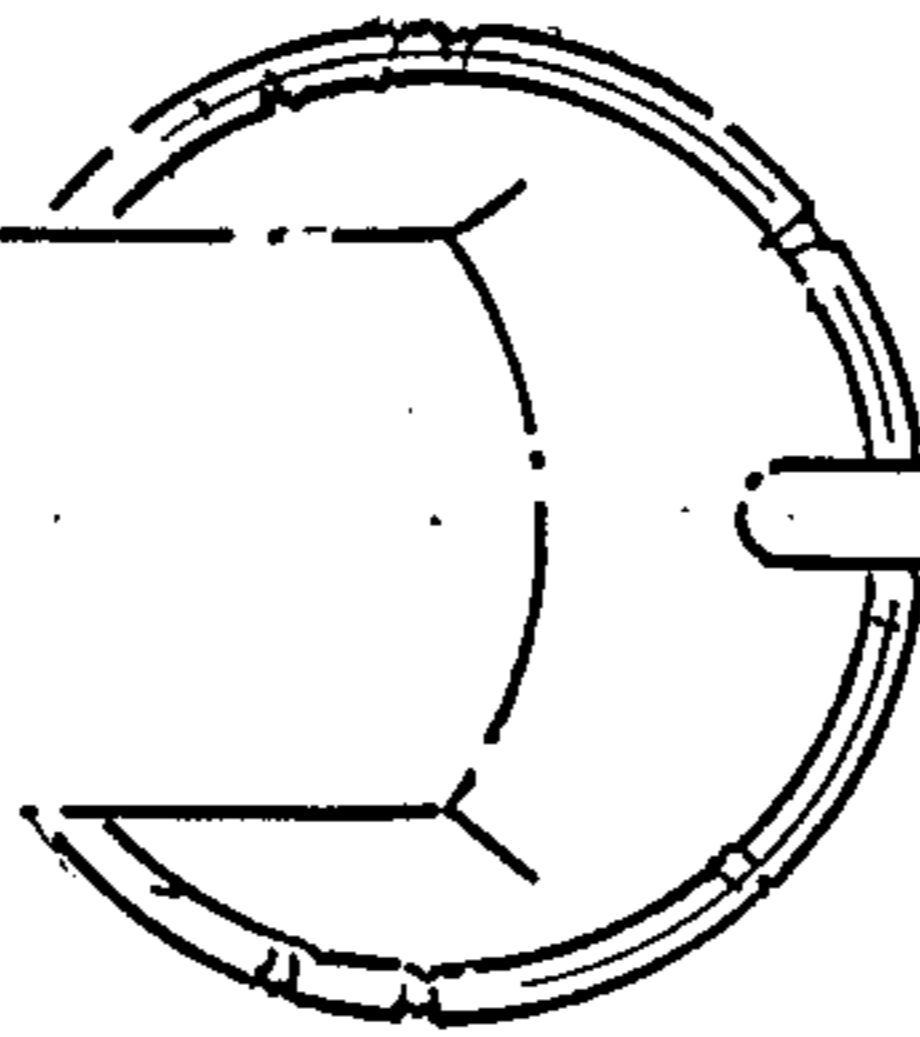
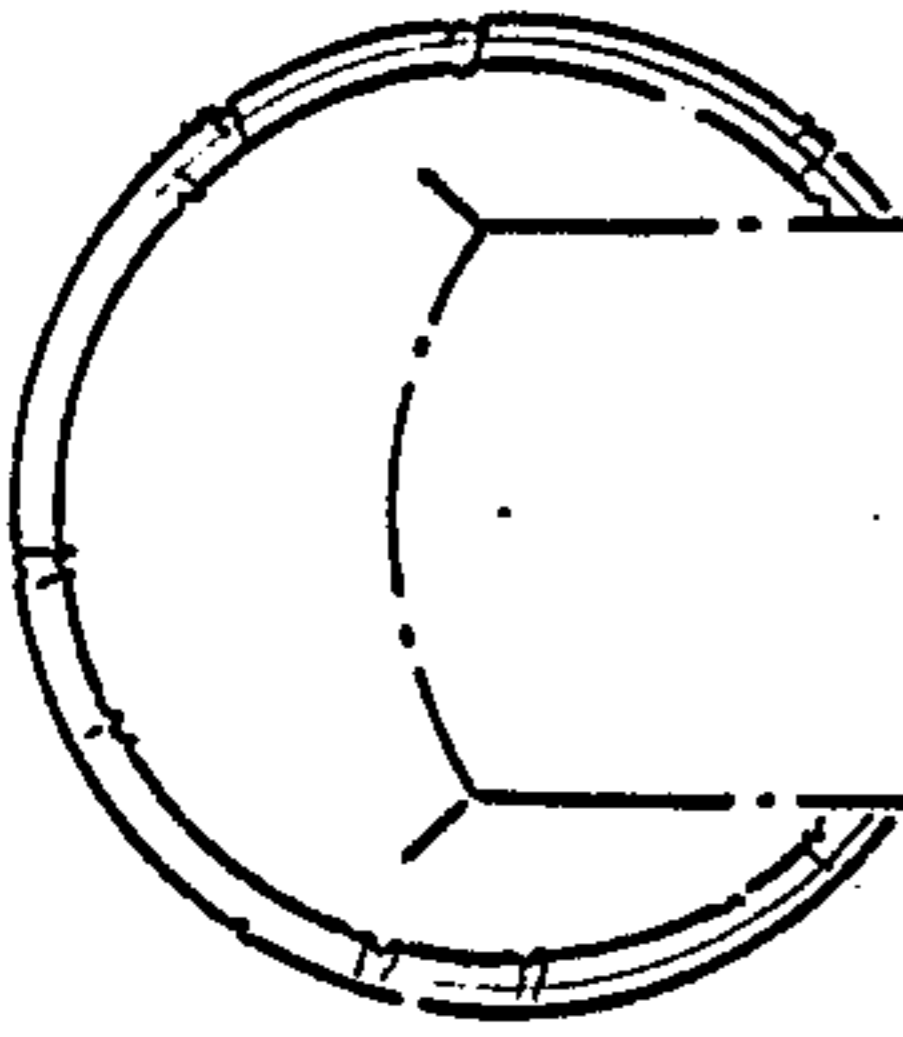

Fig. 8.

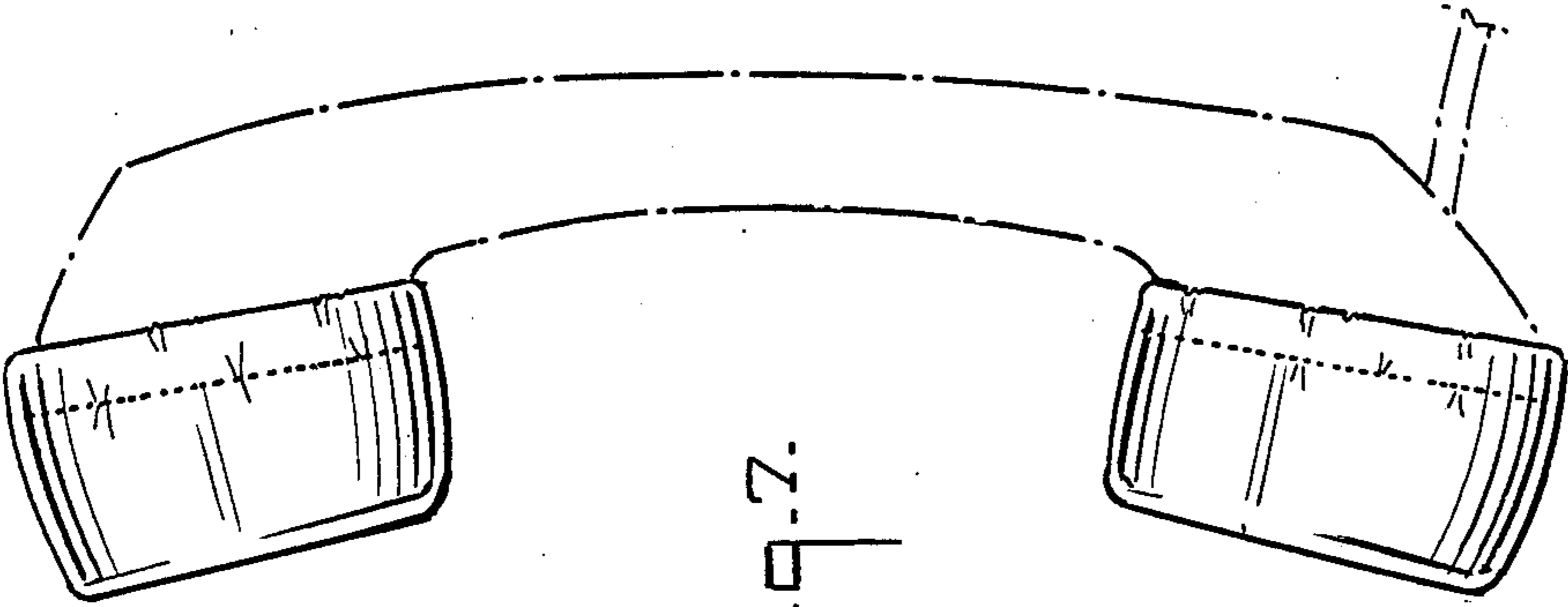

Fig. 7.

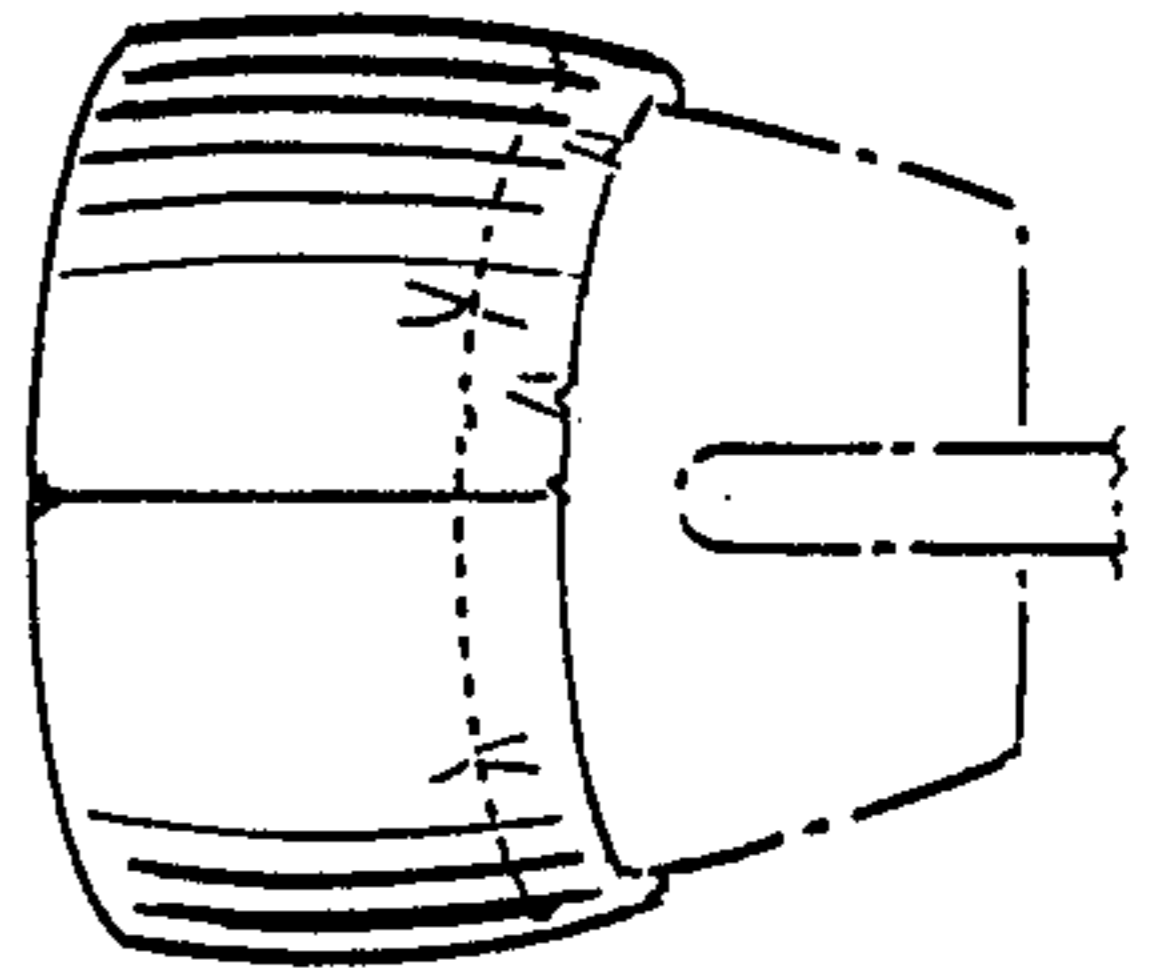

Fig. 10.

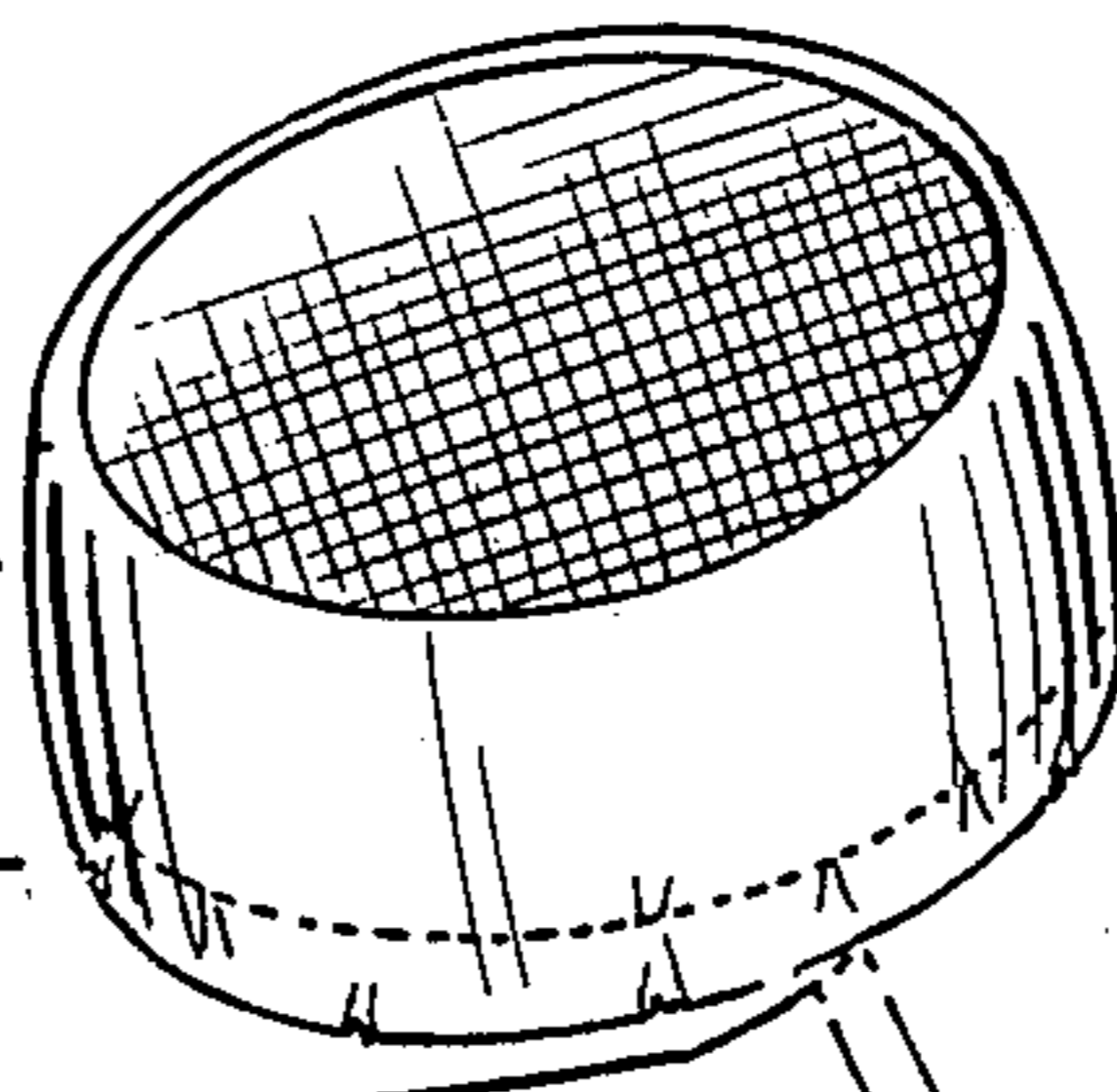
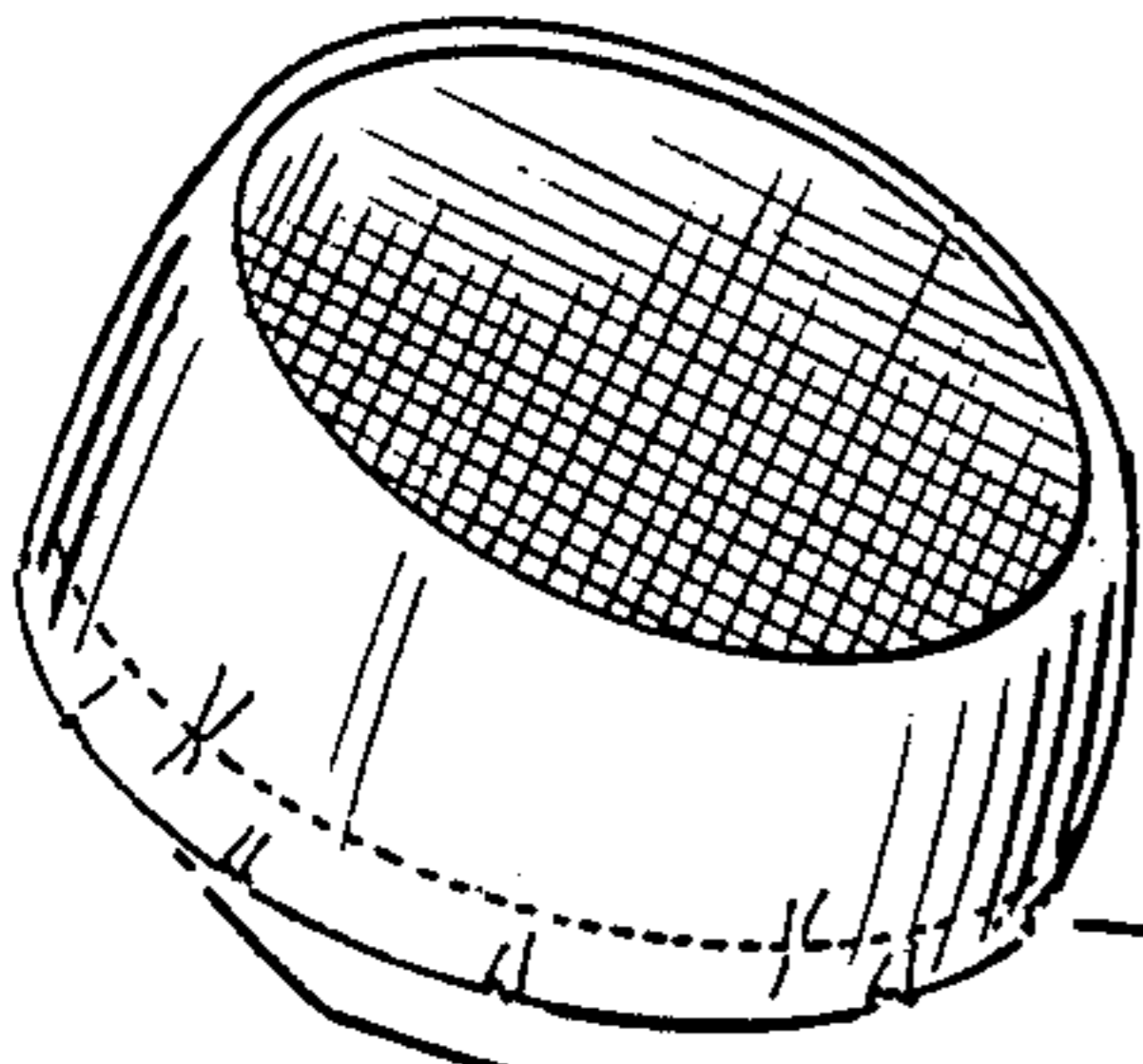

Fig. 6.