

[54] **DENTAL ROUTER**

[75] **Inventor: Bernard Weissman, New York, N.Y.**

[73] **Assignee: IPCO Corporation, White Plains, N.Y.**

[**] **Term: 14 Years**

[21] **Appl. No.: 14,648**

[22] **Filed: Feb. 13, 1987**

[52] **U.S. Cl. D24/10; D24/4; D15/124**

[58] **Field of Search D24/4-5, D24/10, 16; D8/61; 433/25, 49-51; D15/124**

[56] **References Cited**

U.S. PATENT DOCUMENTS

D. 277,287 1/1985 Baer D15/124
1,617,523 2/1927 Irish 433/51
2,414,056 1/1947 Nieman 433/51

Primary Examiner—Wallace R. Burke
Assistant Examiner—Brian N. Vinson
Attorney, Agent, or Firm—Helfgott & Karas

[57] **CLAIM**

The ornamental design for a dental router, as shown.

DESCRIPTION

FIG. 1 is a top, front and right side perspective view of a dental router showing my new design;
FIG. 2 is a top plan view thereof;
FIG. 3 is a front elevational view thereof;
FIG. 4 is a rear view thereof;
FIG. 5 is a left side elevational view thereof; and
FIG. 6 is a bottom plan view thereof.

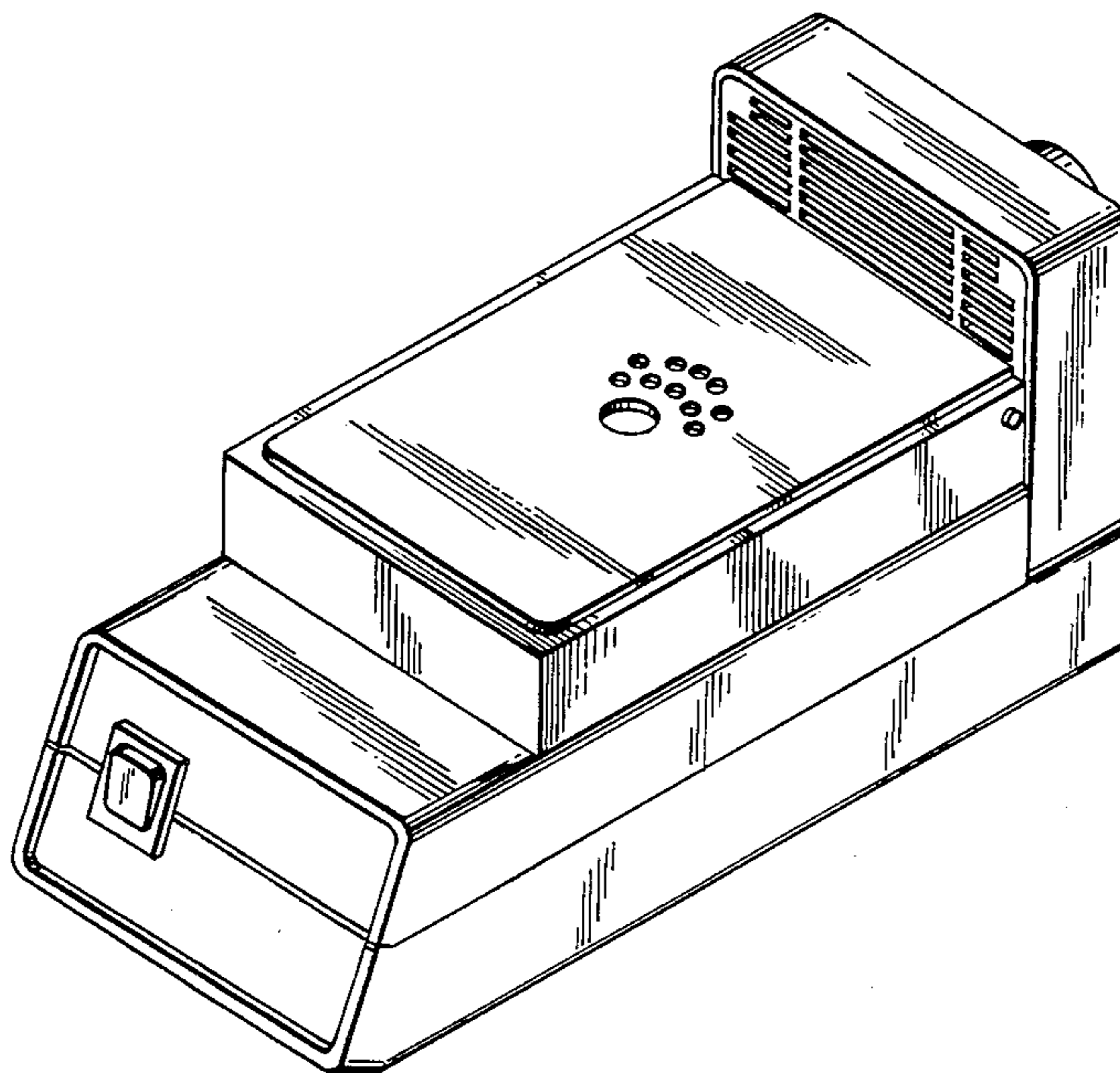

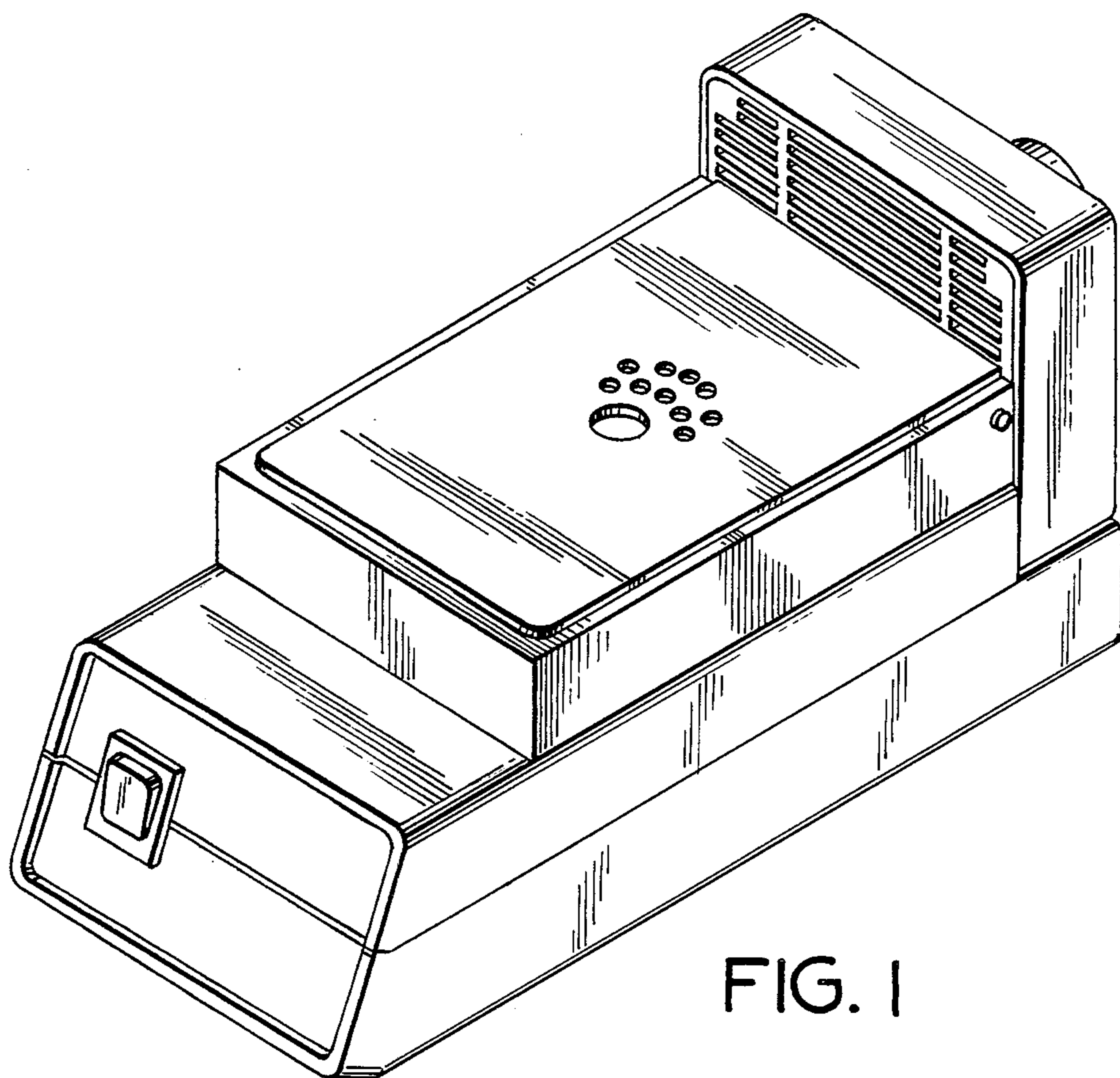

FIG. 1

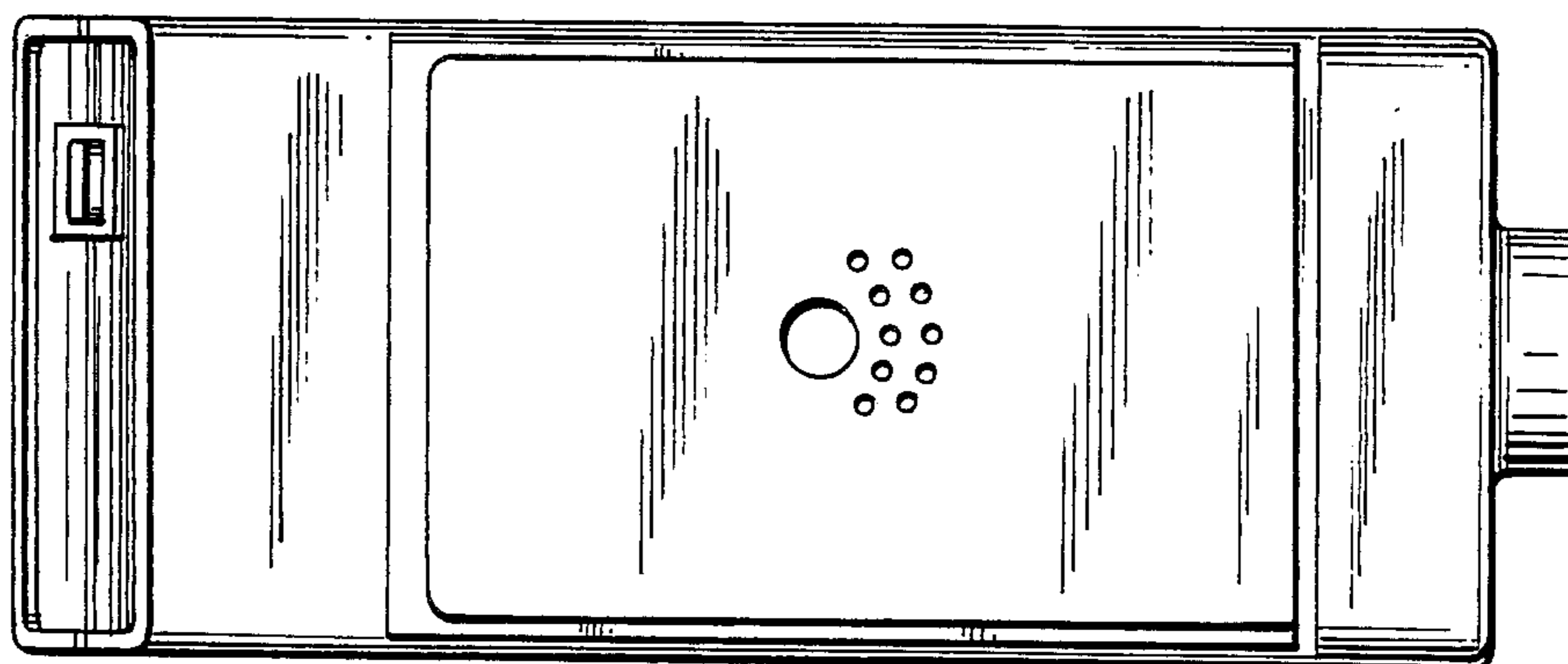

FIG. 2

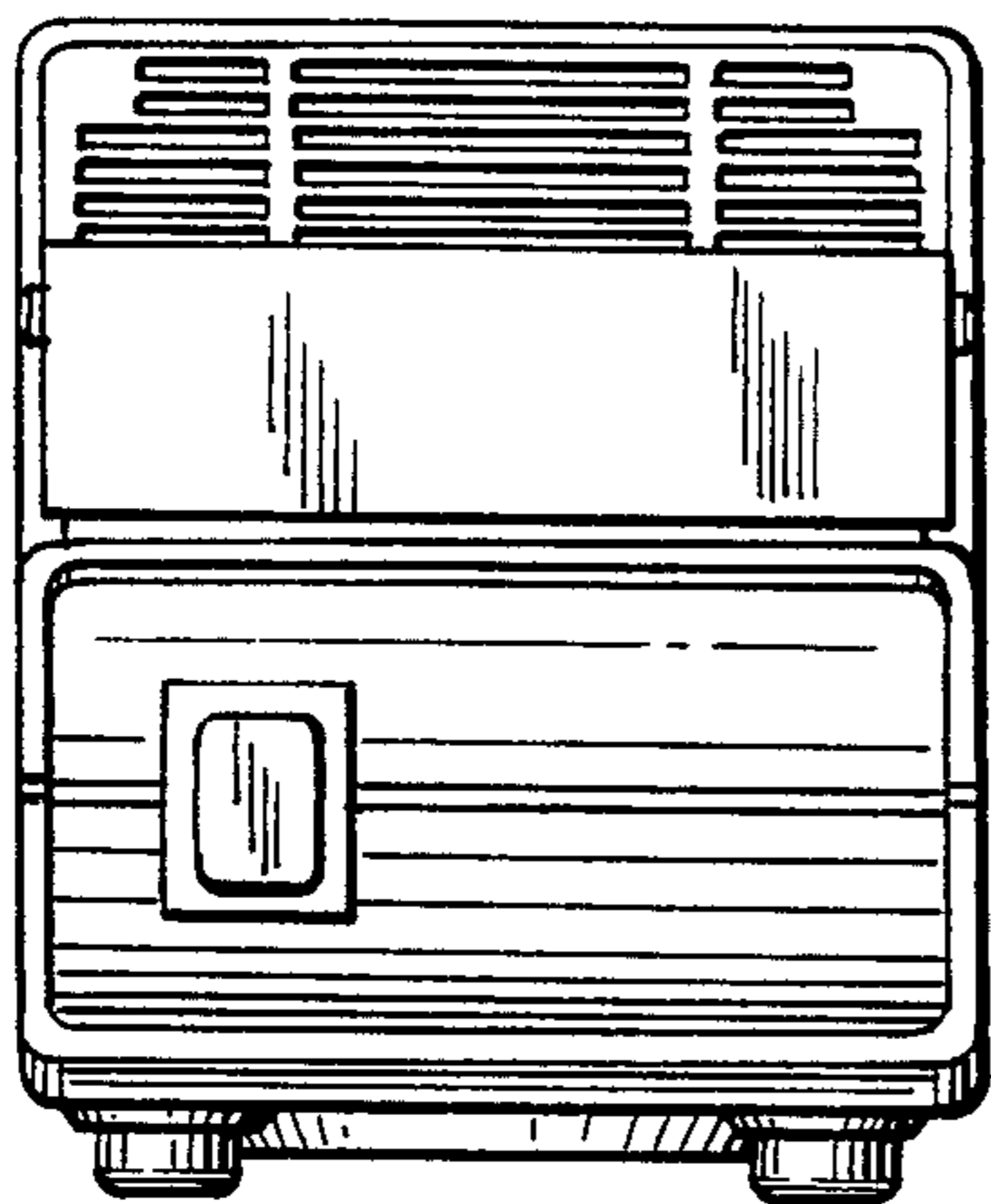

FIG. 3

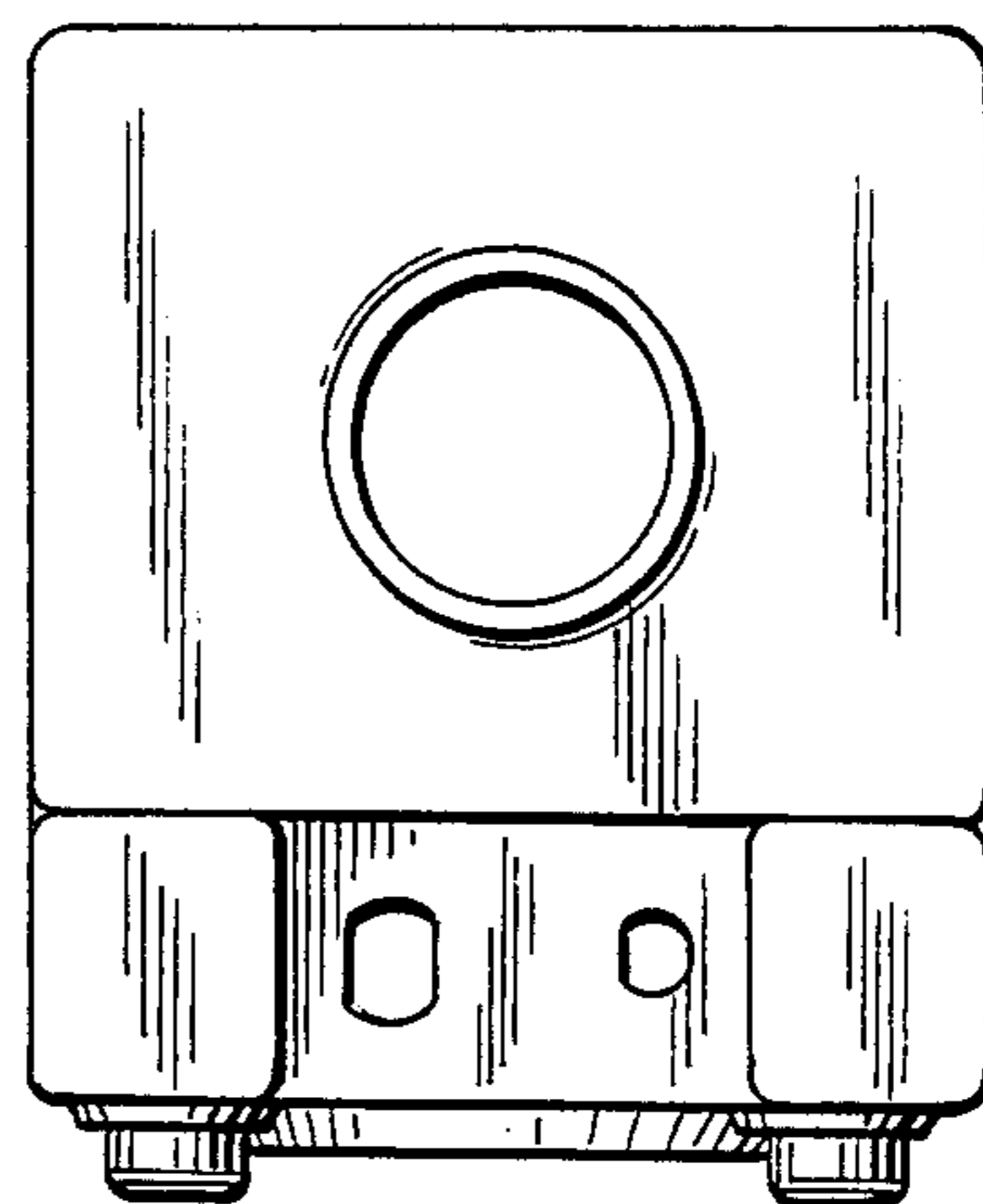

FIG. 4

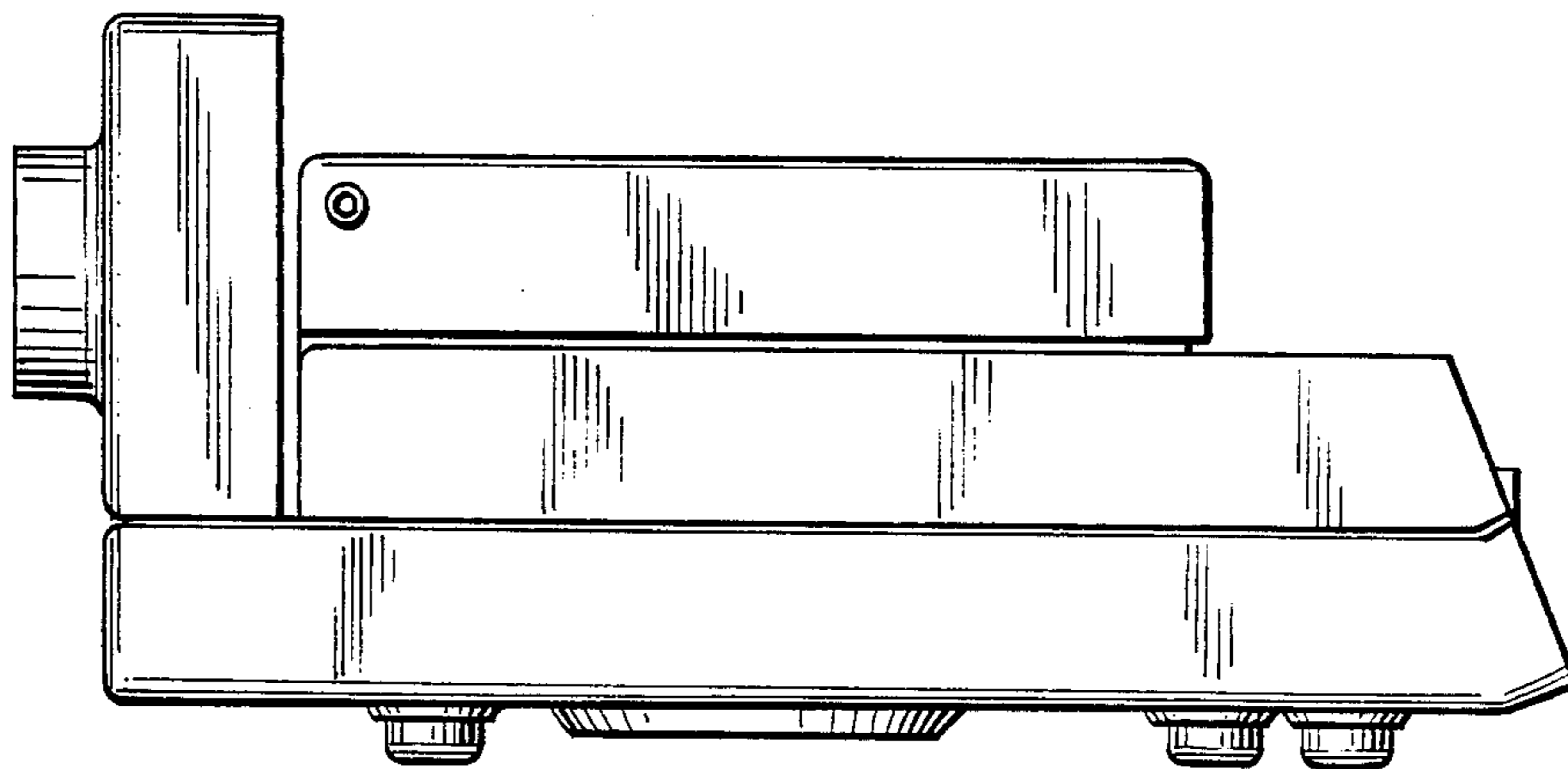

FIG. 5

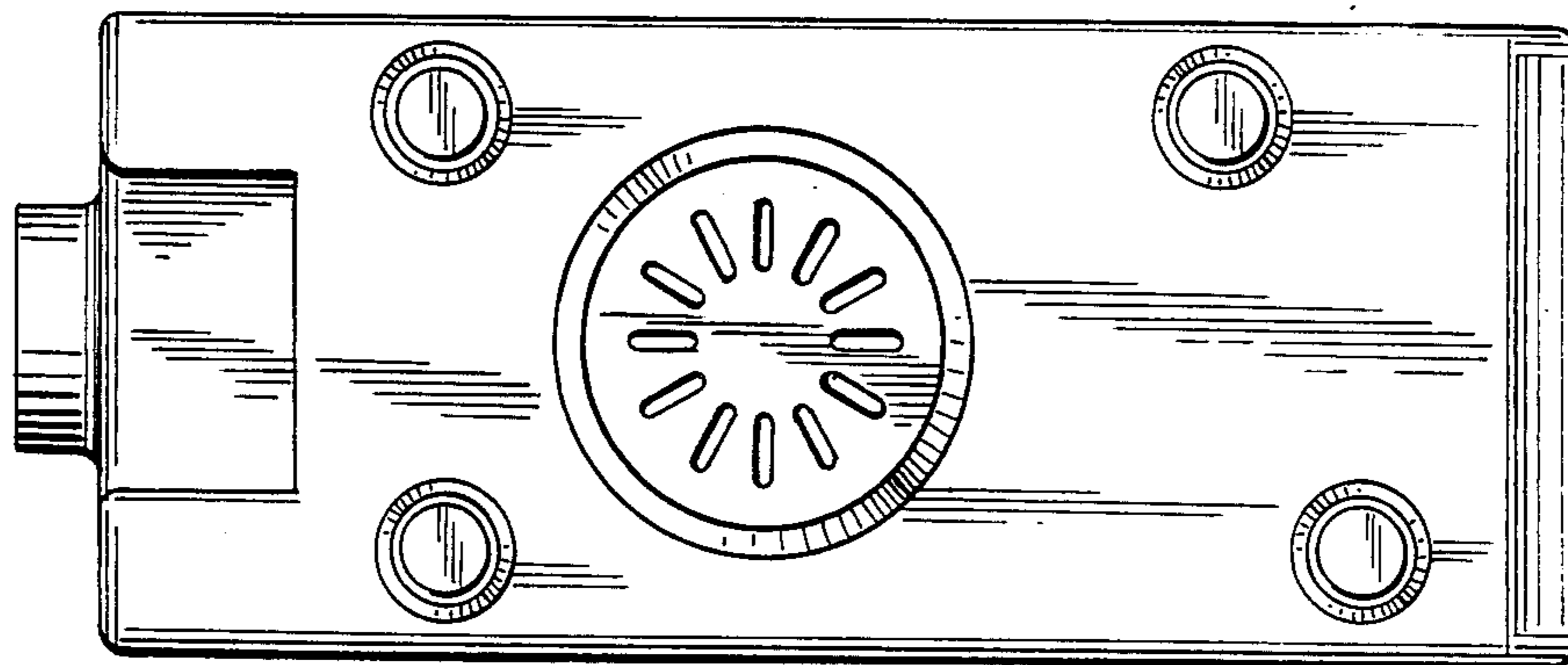

FIG. 6