

[54] COMBINED TERRARIUM AND AQUARIUM

[76] Inventor: Michael D. McKeever, 1808 Sunset Pt. Rd., Apt. K, Clearwater, Fla. 33575

[**] Term: 14 Years

[21] Appl. No.: 892,775

[22] Filed: Aug. 4, 1986

[52] U.S. Cl. D30/104; D11/145

[58] Field of Search D30/1-8; D11/145; 119/5

- 4,026,243 5/1977 Jessop, IV .
- 4,117,805 10/1978 Ward .
- 4,122,800 10/1978 Mangarell .
- 4,175,513 11/1979 Roehrick .
- 4,351,270 9/1982 Sabin .
- 4,414,919 11/1983 Hess .
- 4,528,940 7/1985 Litzburg .

Primary Examiner—James R. Largen
Attorney, Agent, or Firm—Pettis & McDonald

[57] CLAIM

The ornamental design for a combined terrarium and aquarium, as shown.

DESCRIPTION

FIG. 1 is a front elevational view of the combined terrarium and aquarium showing my new design.
 FIG. 2 is a top plan view thereof.
 FIG. 3 is a bottom plan view thereof.
 FIG. 4 is a rear elevational view thereof.
 FIG. 5 is a right side elevational view thereof.
 FIG. 6 is a left side elevational view thereof.
 FIG. 7 is a perspective view thereof.
 FIG. 8 is an enlarged cross-sectional view taken along line 8—8 of FIG. 2.

[56] References Cited

U.S. PATENT DOCUMENTS

- D. 117,704 11/1939 Zenzen D30/104
- D. 208,243 8/1967 Hayward D30/105
- D. 238,591 1/1976 De Shores et al. D30/105
- D. 244,623 6/1977 Braid D30/101
- D. 285,841 9/1986 Tigert D30/101
- D. 285,846 9/1986 Tigert D30/101
- D. 286,691 11/1986 Jones D30/105
- 2,877,051 3/1959 Cushman et al. .
- 3,699,921 10/1972 Janicek .
- 3,921,583 11/1975 De Shores 119/5

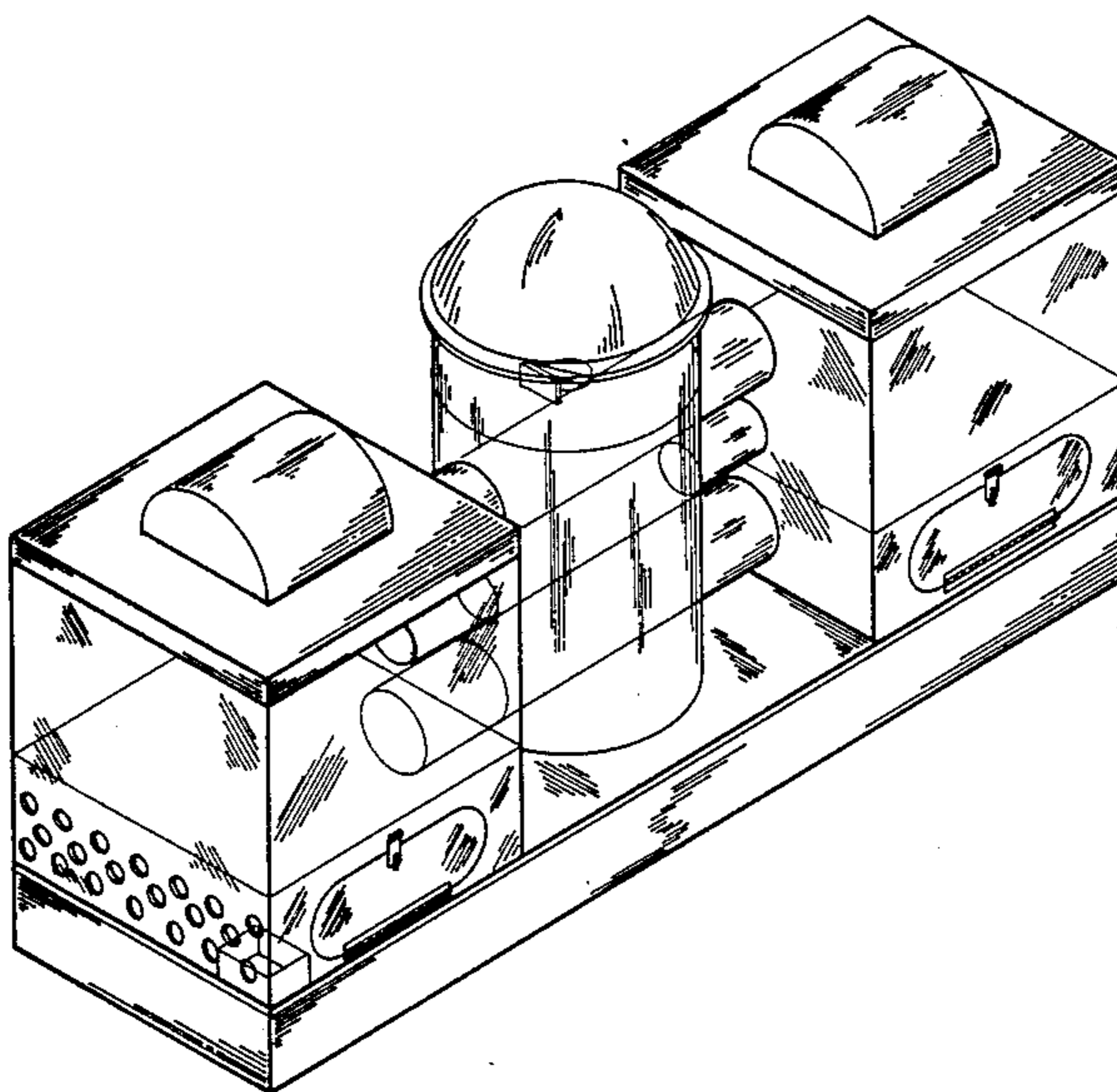

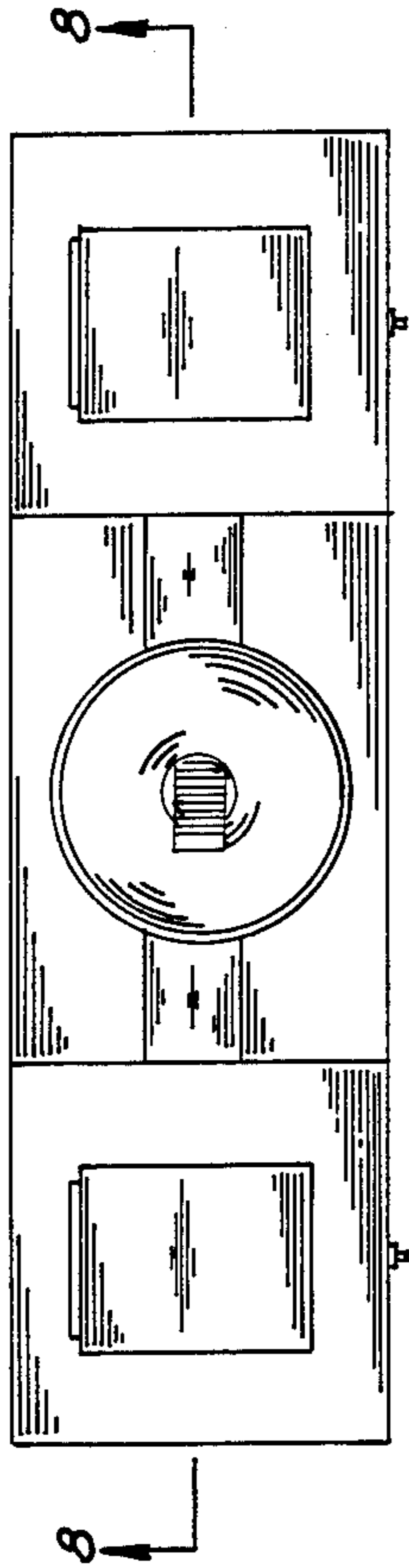

FIG. 2

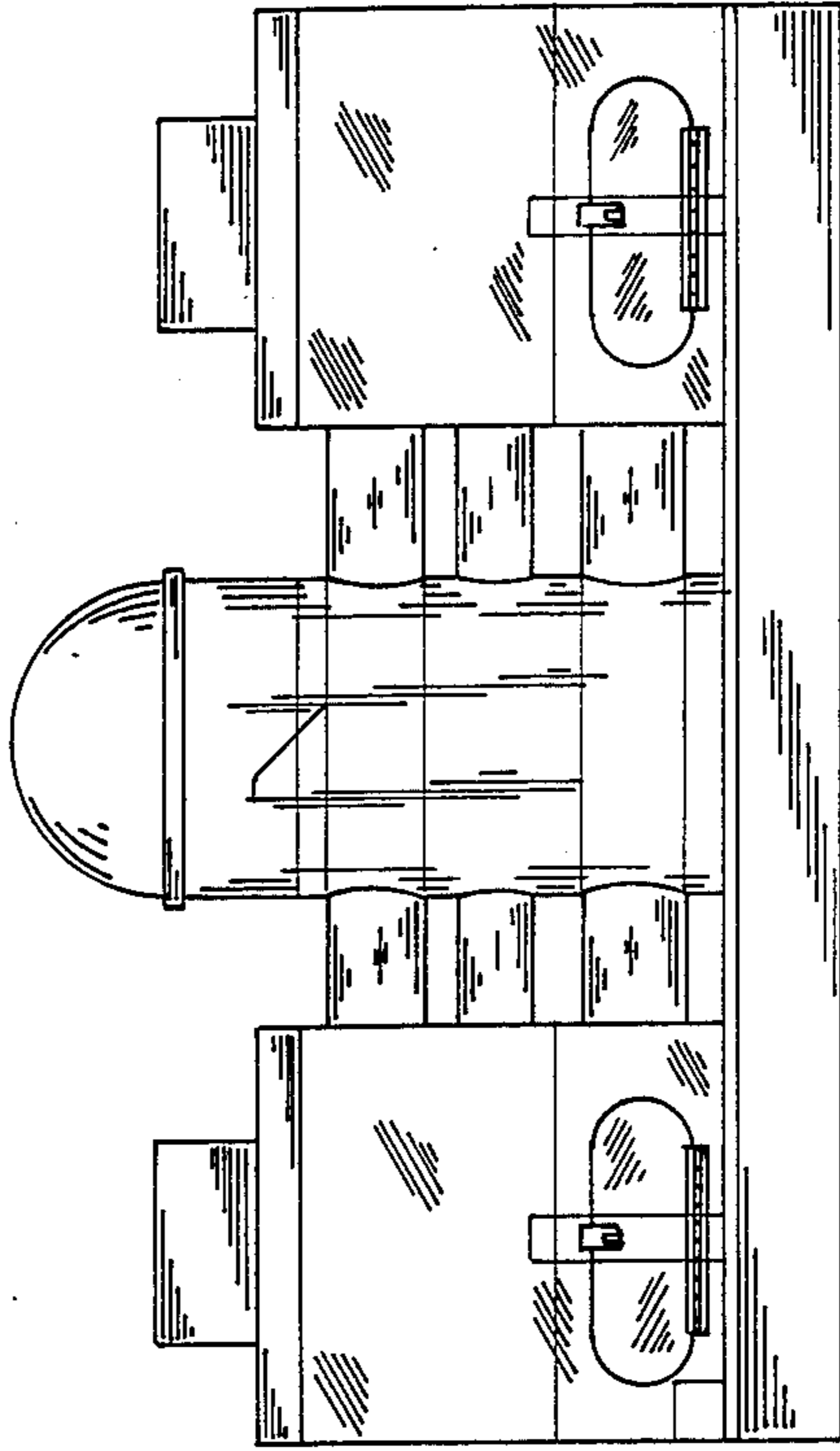

FIG. 1

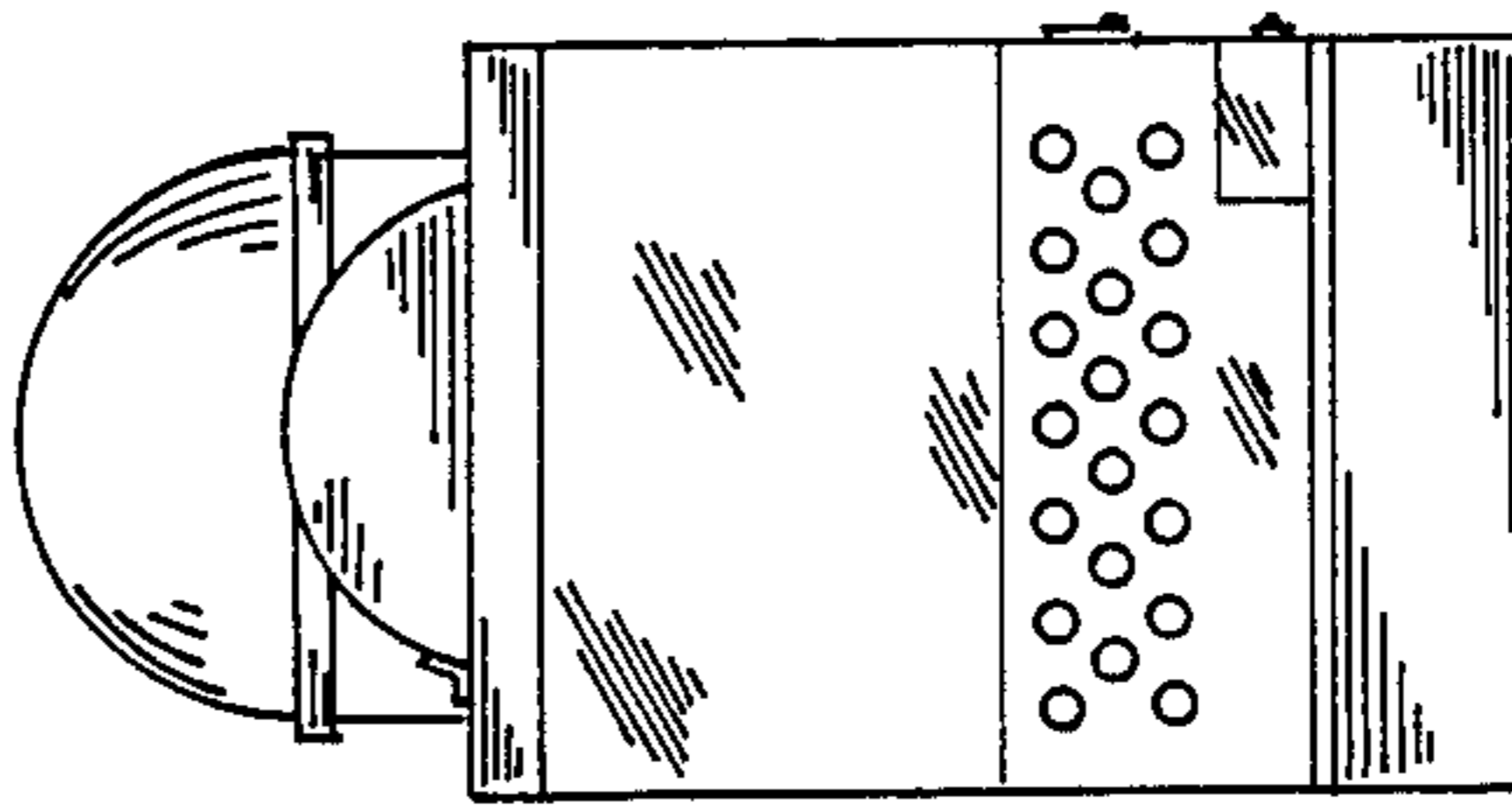

FIG. 6

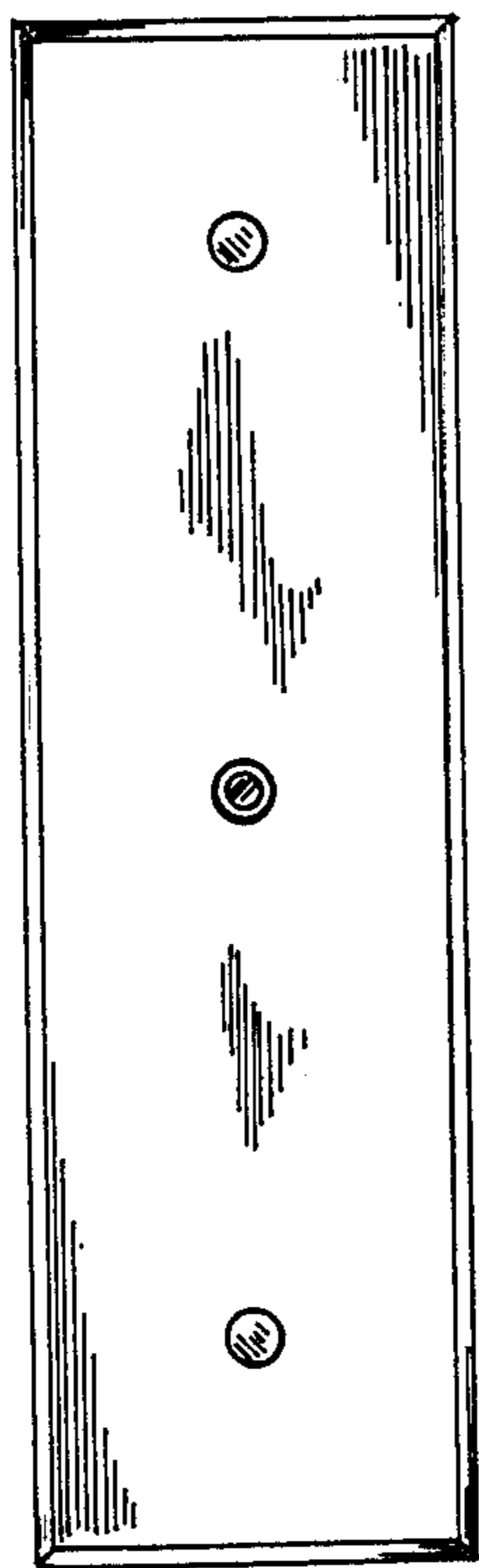

FIG. 3

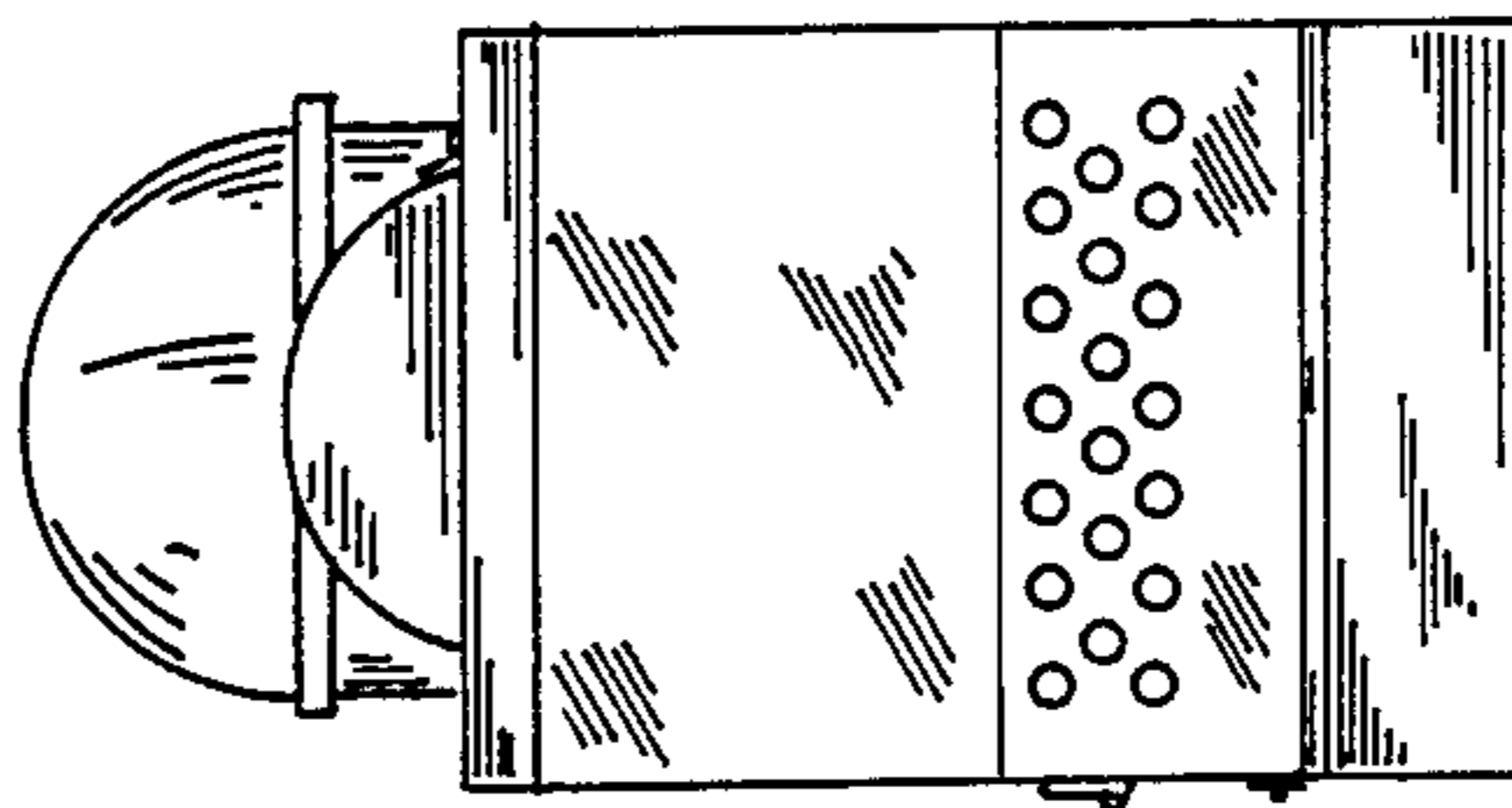

FIG. 5

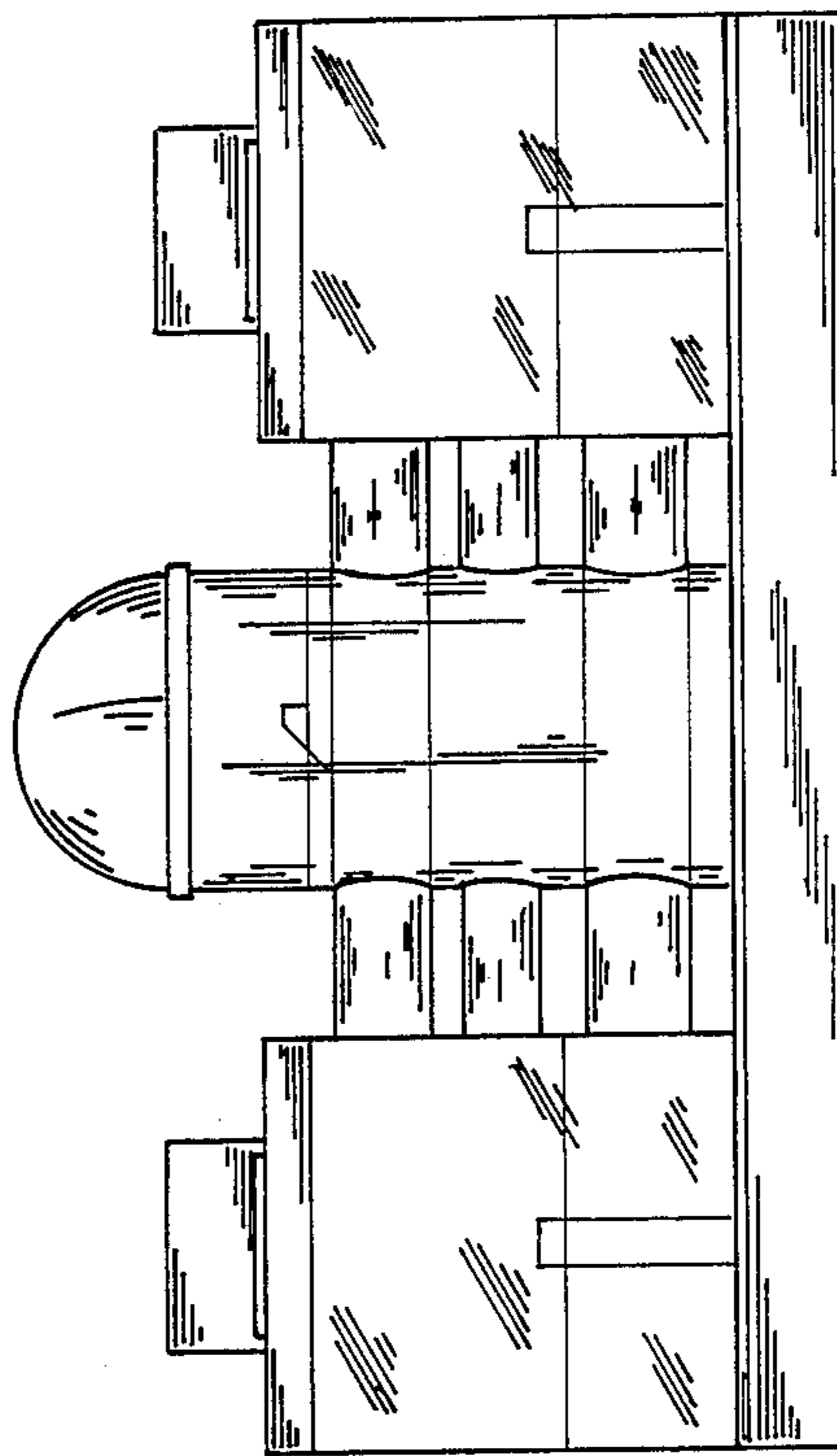

FIG. 4

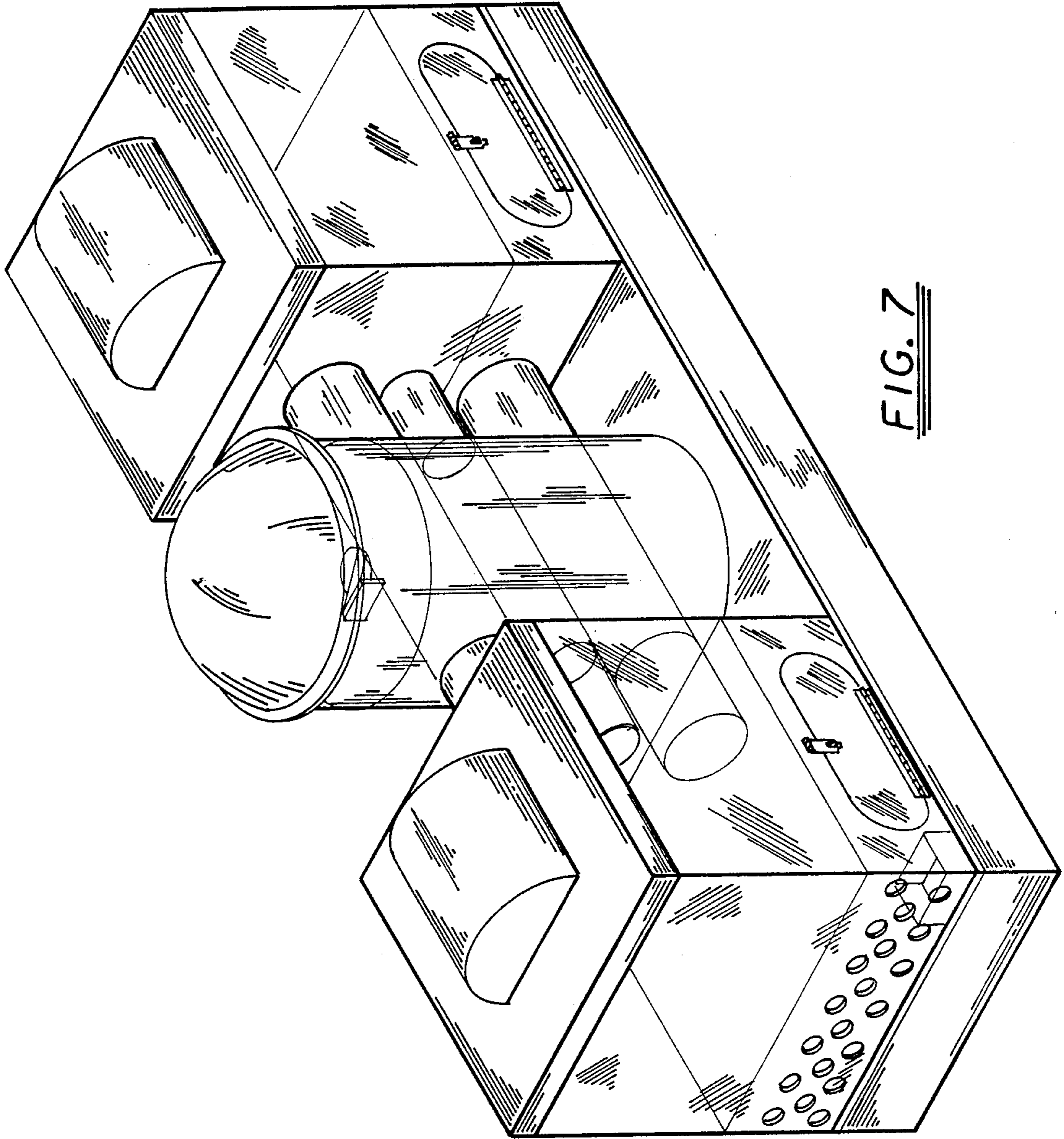

FIG. 7

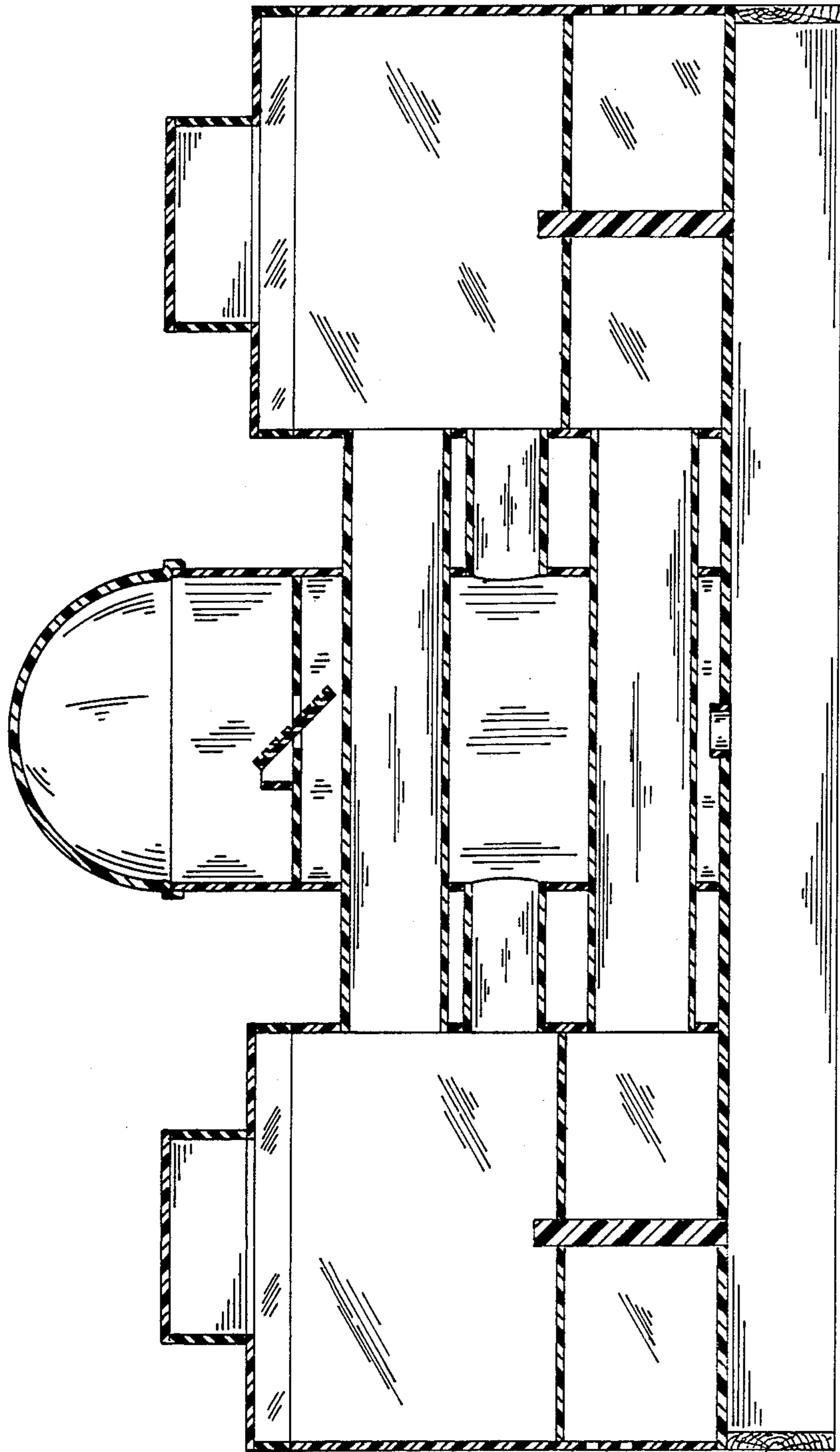

FIG. 8