

[54] DOOR GATE

[56] References Cited

[75] Inventor: Stanley M. Kujawski, East Aurora, N.Y.

U.S. PATENT DOCUMENTS

4,677,791 7/1987 Larson et al. 49/55 X
4,702,036 10/1987 Johnson 49/55

[73] Assignee: The Quaker Oats Company, Chicago, Ill.

Primary Examiner—A. Hugo Word
Attorney, Agent, or Firm—Cumpston & Shaw

[**] Term: 14 Years

[57] CLAIM

The ornamental design for a door gate, as shown and described.

[21] Appl. No.: 182,567

DESCRIPTION

[22] Filed: Apr. 18, 1988

FIG. 1 is a front elevational view of a door gate showing my new design;

[52] U.S. Cl. D25/50

FIG. 2 is a right-side elevational view thereof;

[58] Field of Search 49/50, 54, 55, 56, 57, 49/142, DIG. 2; D25/39, 50, 48; 256/23, 24, 73

FIG. 3 is a rear elevational view thereof;

FIG. 4 is a left-side elevational view thereof;

FIG. 5 is a top plan view thereof; and

FIG. 6 is a bottom plan view.

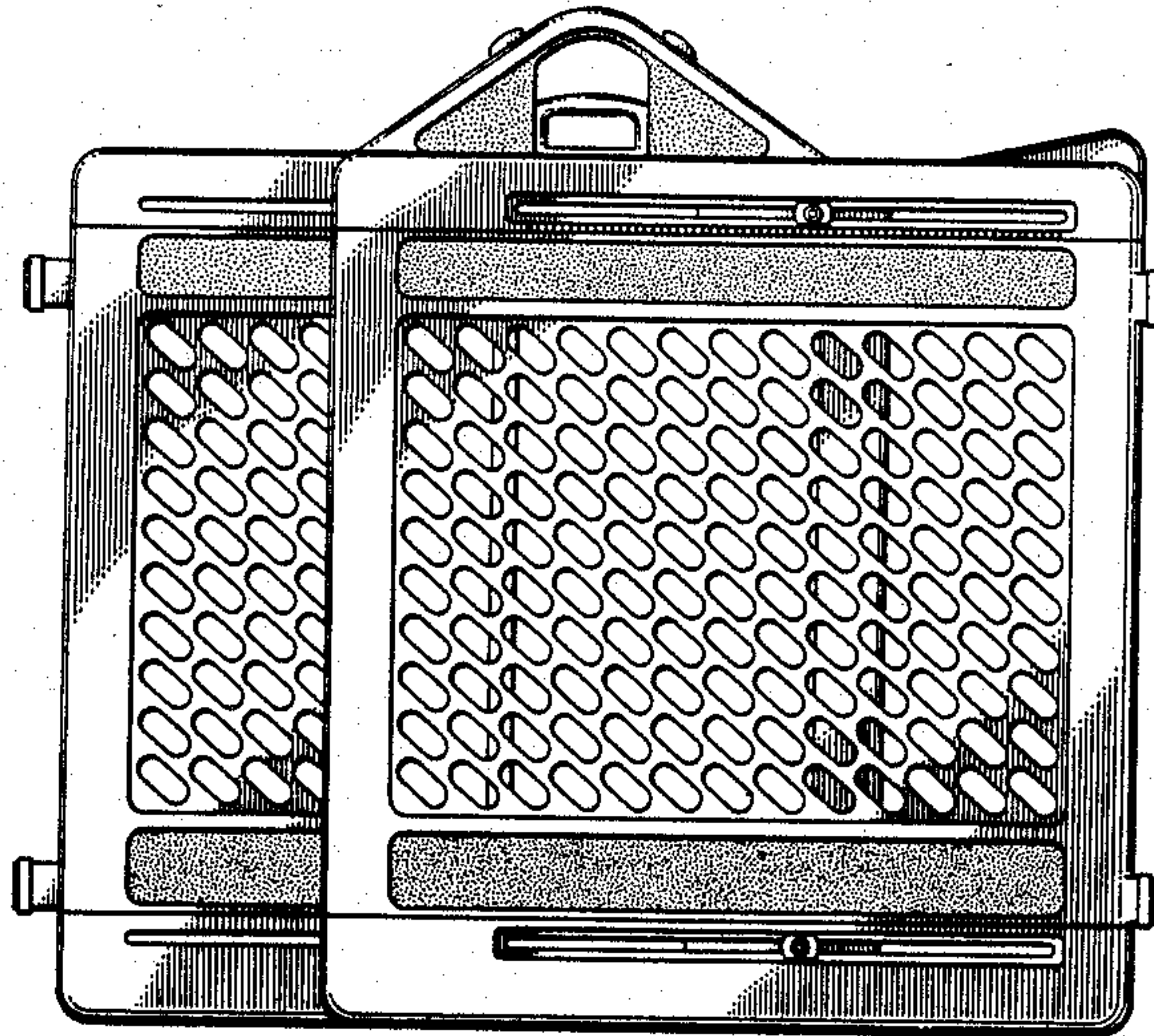

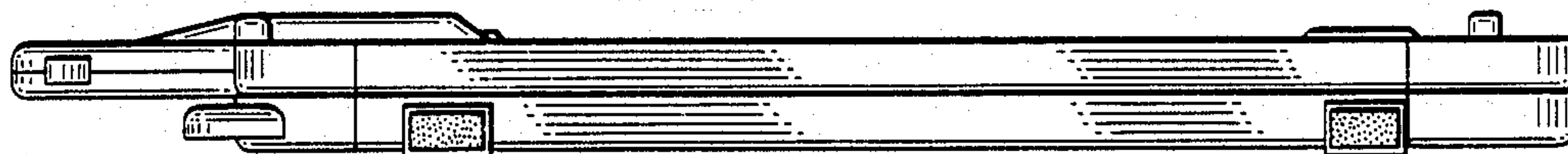

FIG. 2

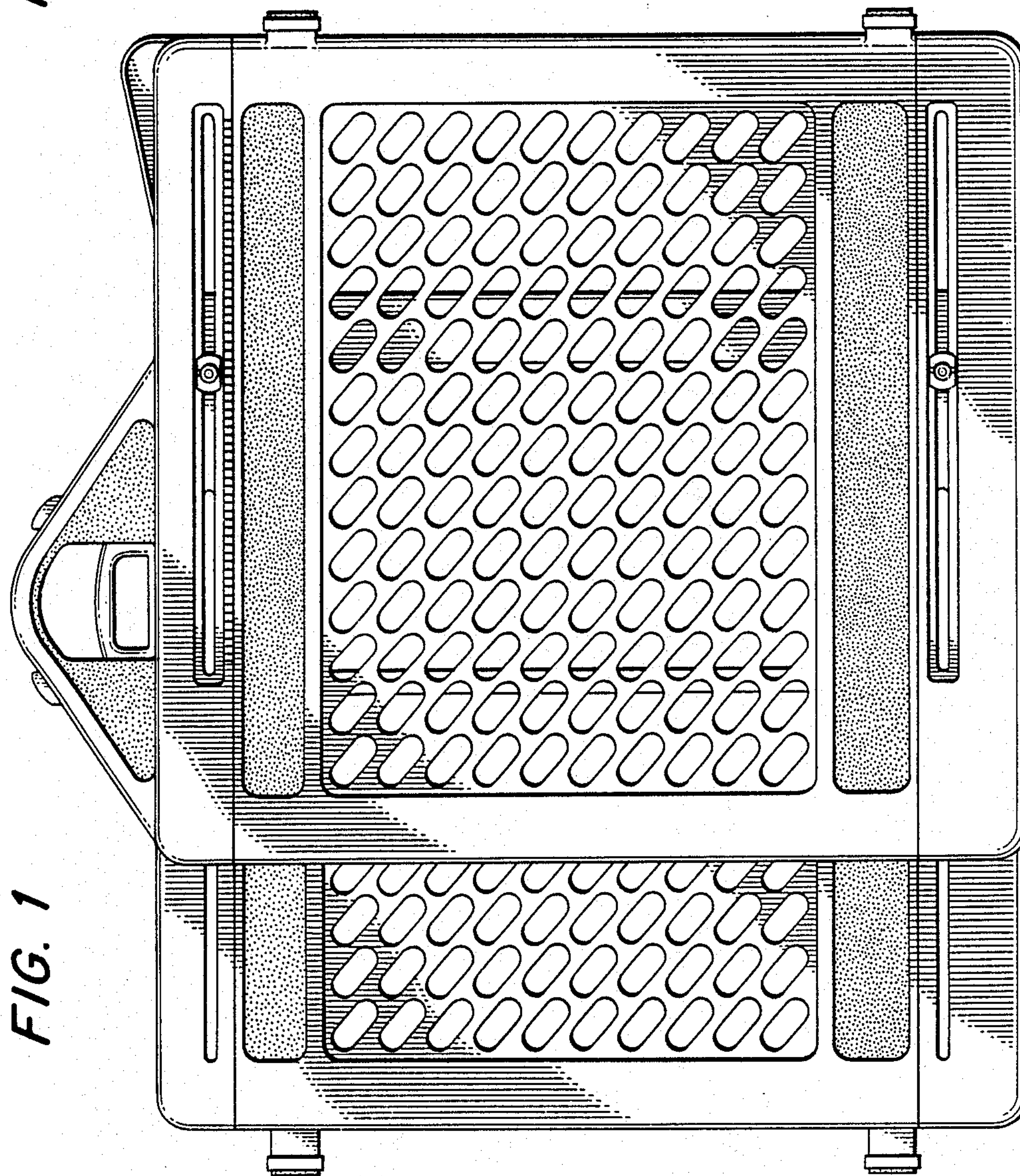

FIG. 1

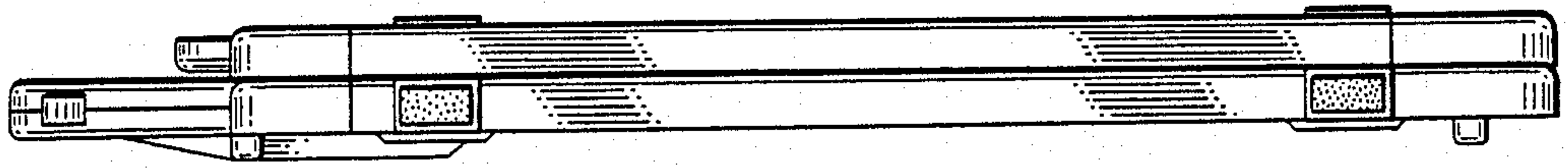

FIG. 4

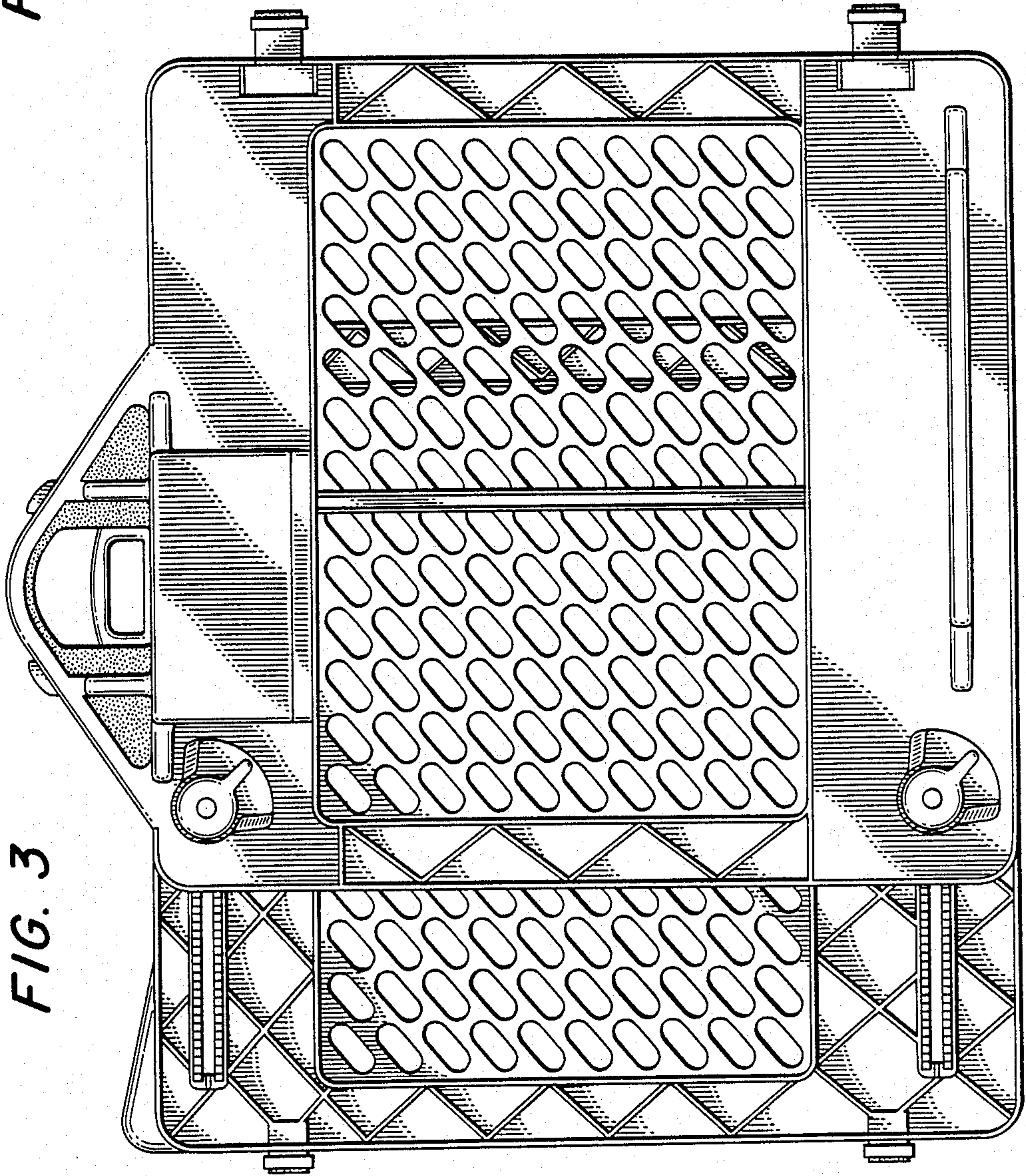

FIG. 3

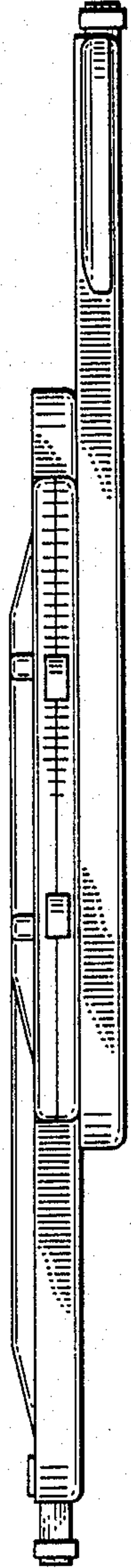

FIG. 5

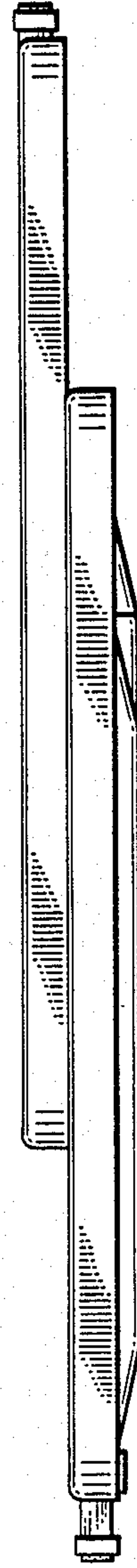

FIG. 6