

[54] ELECTRIC MASSAGER

[75] Inventors: Kazuyoshi Yonesawa, Suita; Kuniharu Ichikawa, Kyoto; Taro Mochida, Hirakata, all of Japan

[73] Assignee: Matsushita Electric Works, Ltd., Osaka, Japan

[\*\*] Term: 14 Years

[21] Appl. No.: 9,125

[22] Filed: Jan. 30, 1987

[30] Foreign Application Priority Data

Aug. 18, 1986 [JP] Japan ..... 61-32117

[52] U.S. Cl. .... D24/41; D24/40

[58] Field of Search ..... D24/41, 42, 40, 36; 128/24.1, 24.3, 24.4, 24.5, 57, 59, 60, 62 R, 67

[56] References Cited

U.S. PATENT DOCUMENTS

D. 228,473 9/1973 Koshido et al. .... D24/41  
4,632,095 12/1986 Libin ..... 128/60 X

FOREIGN PATENT DOCUMENTS

1554644 1/1969 France ..... 128/24.4

OTHER PUBLICATIONS

Best Products catalog-1986, Pollenex Power Massage, item #25, p. 205.

Primary Examiner—Wallace R. Burke  
Assistant Examiner—Stella M. Reid  
Attorney, Agent, or Firm—Burns, Doane, Swecker & Mathis

[57] CLAIM

The ornamental design for an electric massager, as shown and described.

DESCRIPTION

FIG. 1 is a front elevational view of an electric massager showing our design;  
FIG. 2 is a top plan view thereof;  
FIG. 3 is a left side elevational view thereof;  
FIG. 4 is a right side elevational view thereof;  
FIG. 5 is a bottom plan view thereof;  
FIG. 6 is a cross-sectional view taken along line VI—VI of FIG. 3.

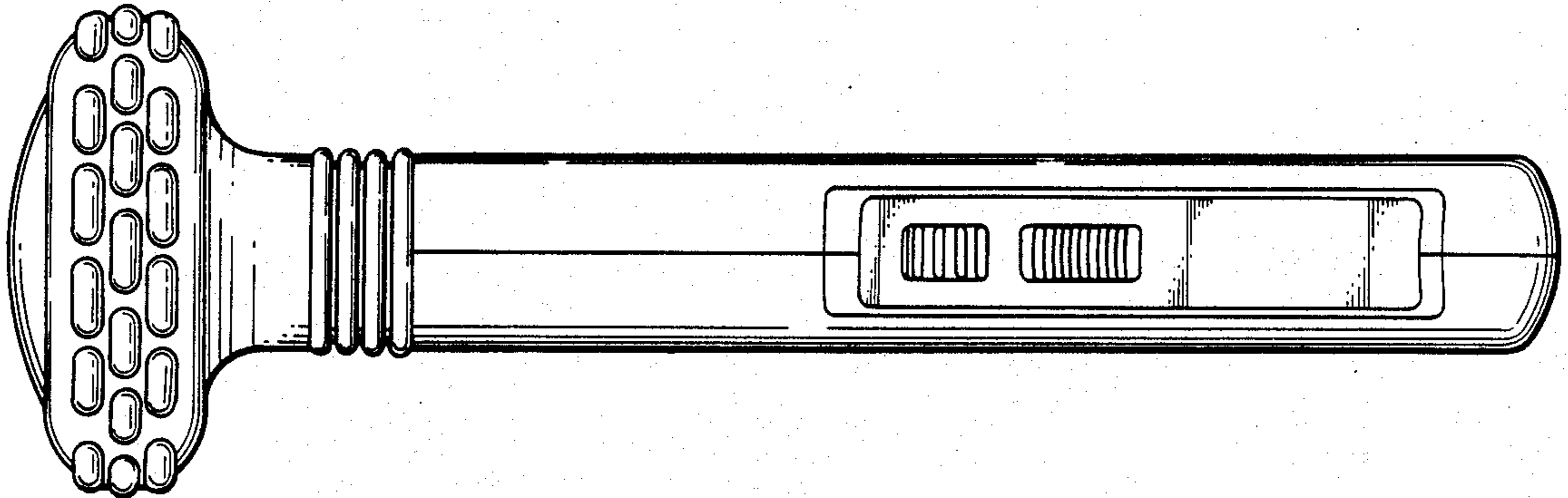
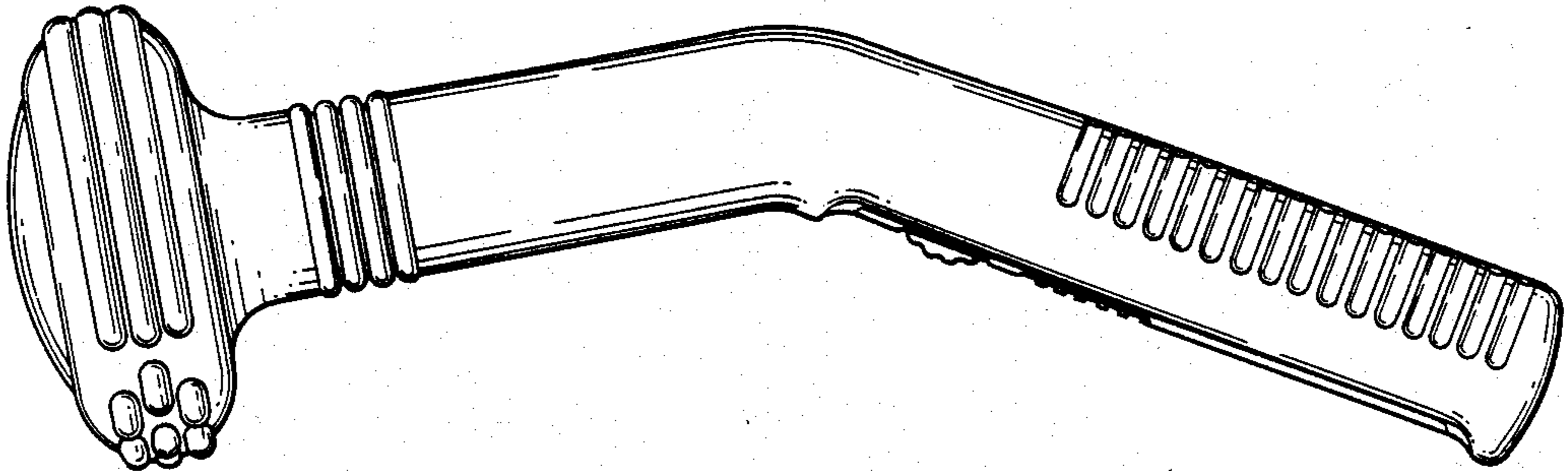

Fig. 1

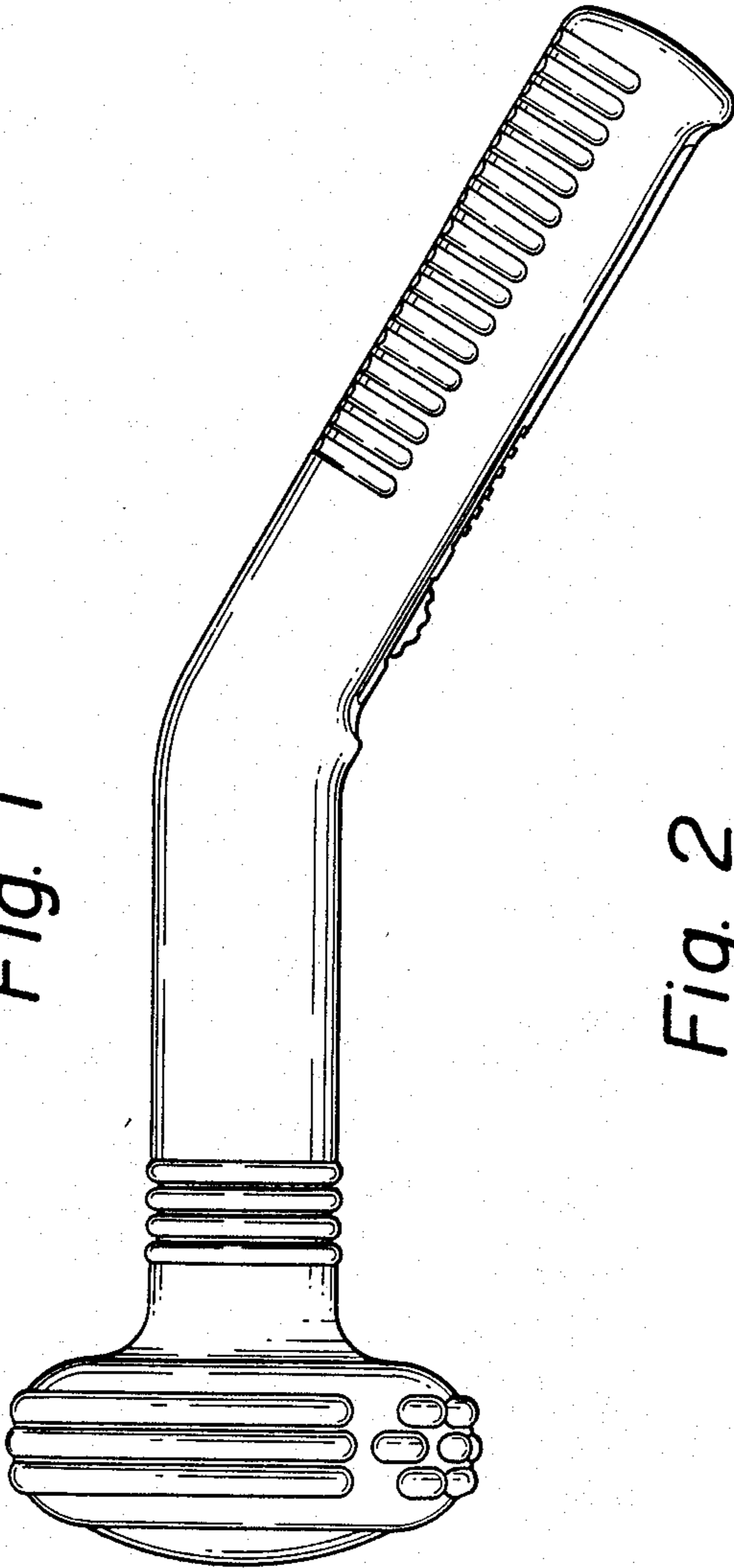

Fig. 2

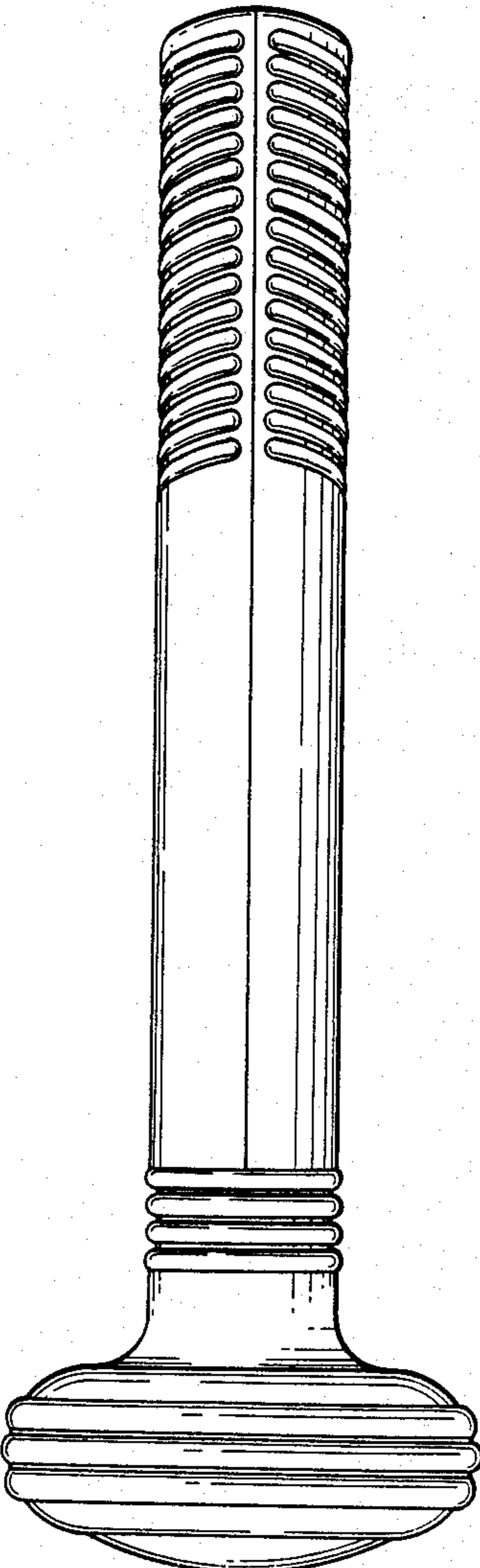

Fig. 3

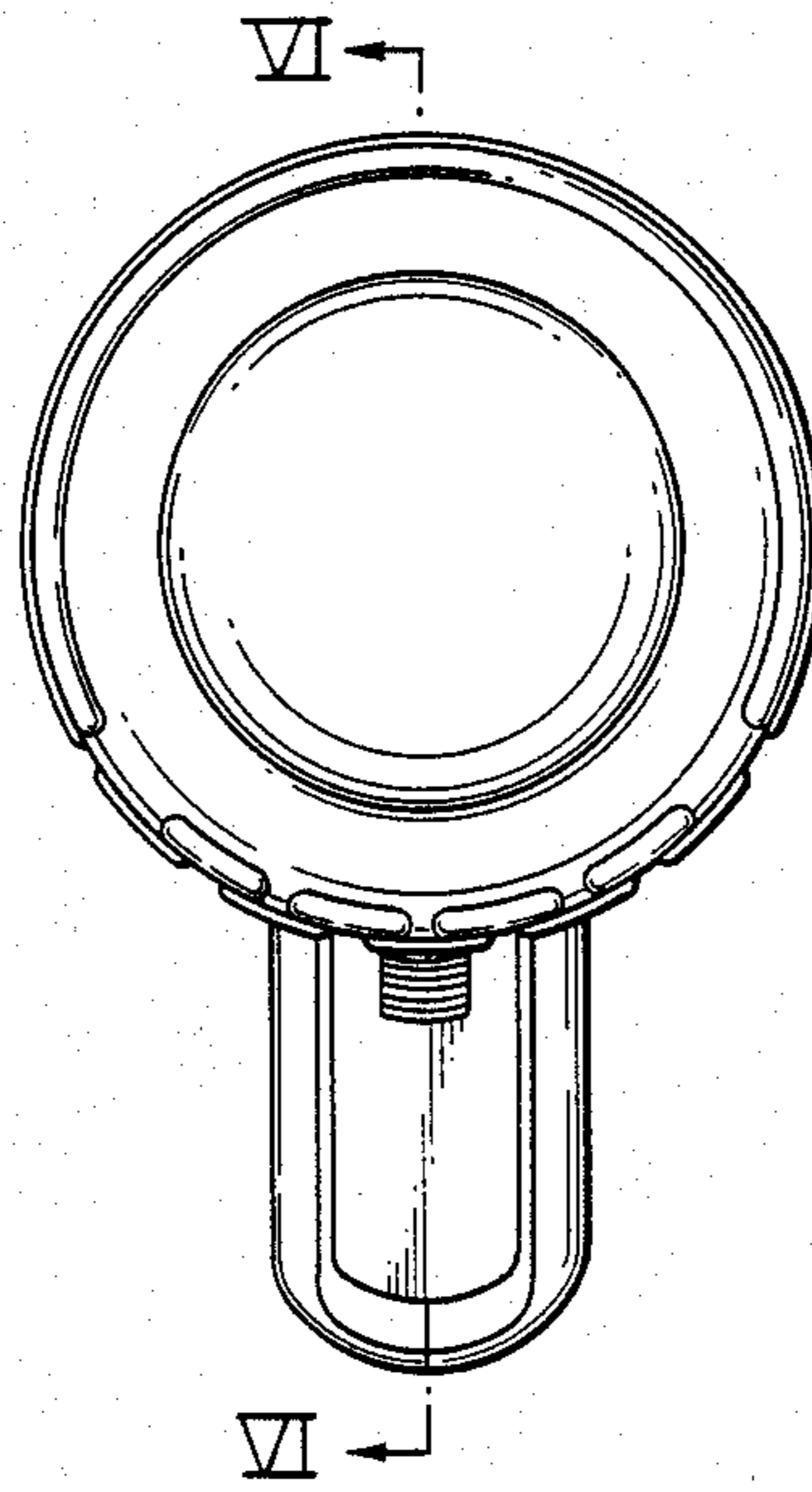

Fig. 4

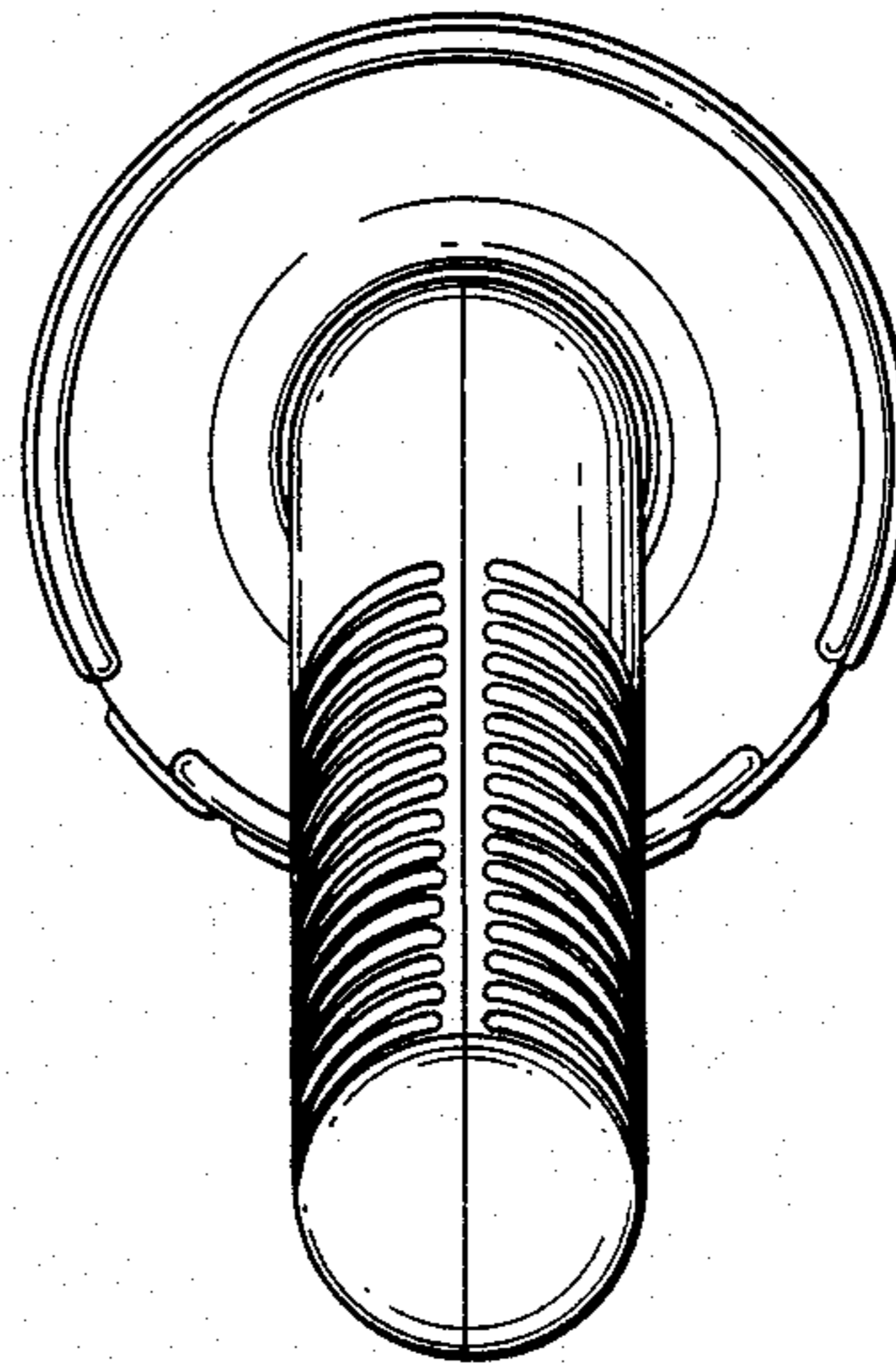

Fig. 5

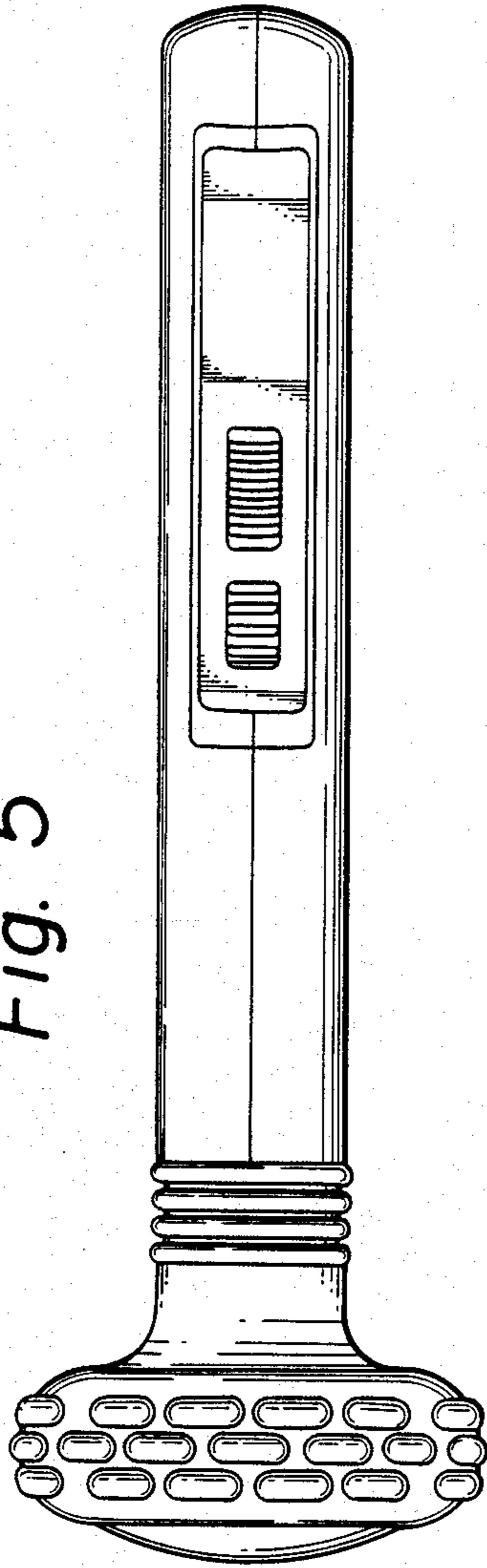

Fig. 6

