

[54] LIGHT CANDLE PACKAGE

[76] Inventor: Robert S. Kelner, 4101 NW. 132 St., Miami, Fla. 33054

[**] Term: 14 Years

[21] Appl. No.: 851,676

[22] Filed: Apr. 14, 1986

[52] U.S. Cl. D9/415

[58] Field of Search D9/414, 415, 416, 418, D9/424, 341; D26/9, 10, 13, 24, 96, 42; 206/418, 419, 420, 486, 487, 488, 601-609, 617, 45.19, 44 R, 44.11

[56] References Cited

U.S. PATENT DOCUMENTS

D. 290,584	6/1987	Lotterer	D9/415
1,449,532	3/1923	Moore	206/419
2,086,300	7/1937	Moffa	206/419
4,022,323	5/1977	Yamazaki	206/419
4,228,896	10/1980	Wu	206/420
4,304,330	12/1981	Winkler et al.	206/45.19

Primary Examiner—Bernard Ansher
Assistant Examiner—Prabhakar Deshmukh
Attorney, Agent, or Firm—John Cyril Malloy

[57] CLAIM

The ornamental design for a light candle package, as shown and described.

DESCRIPTION

FIG. 1 is a front elevation of a light candle package, showing my new design;
FIG. 2 is a left side elevation thereof; the right side elevation is similar to the left side elevation shown;
FIG. 3 is a top plan view thereof;
FIG. 4 is a rear elevation thereof;
FIG. 5 is a bottom plan view thereof;
FIG. 6 is a front elevation of a modified embodiment of a light candle package;
FIG. 7 is a rear elevation thereof;
FIG. 8 is a left side elevation thereof, the right side elevation is similar to the left side elevation shown;
FIG. 9 is a bottom plan view thereof; and
FIG. 10 is a top plan view thereof.

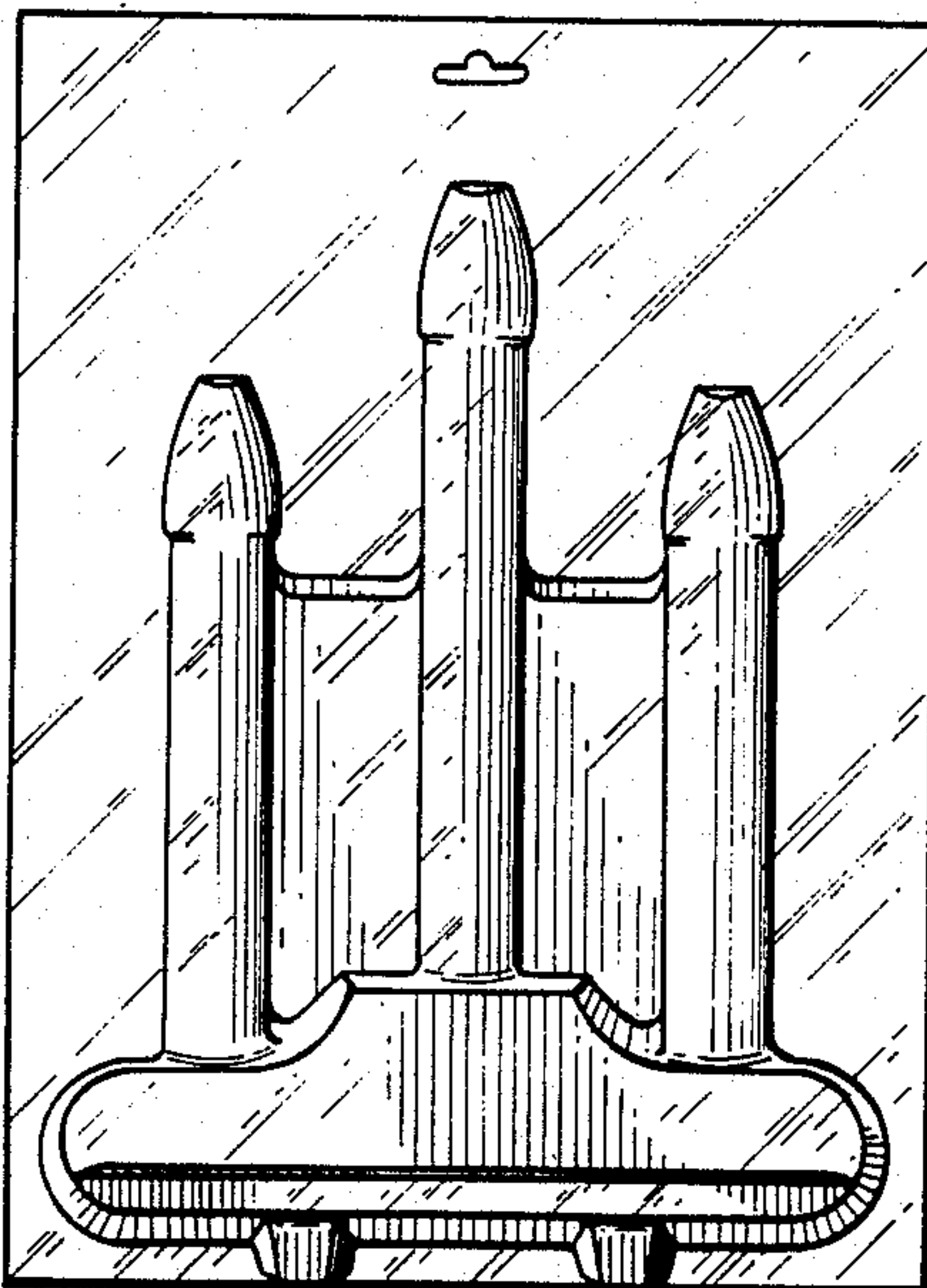

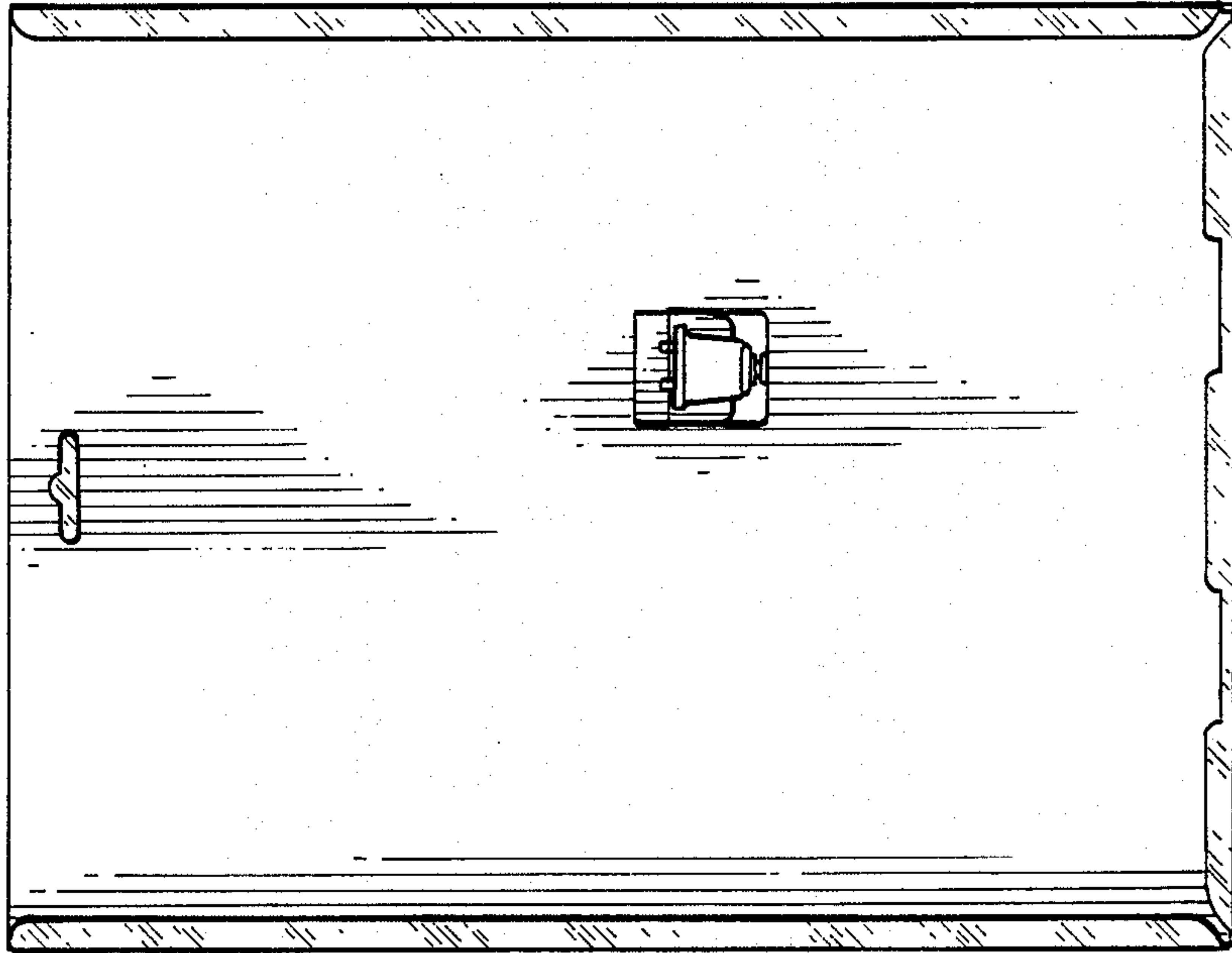

FIG. 4

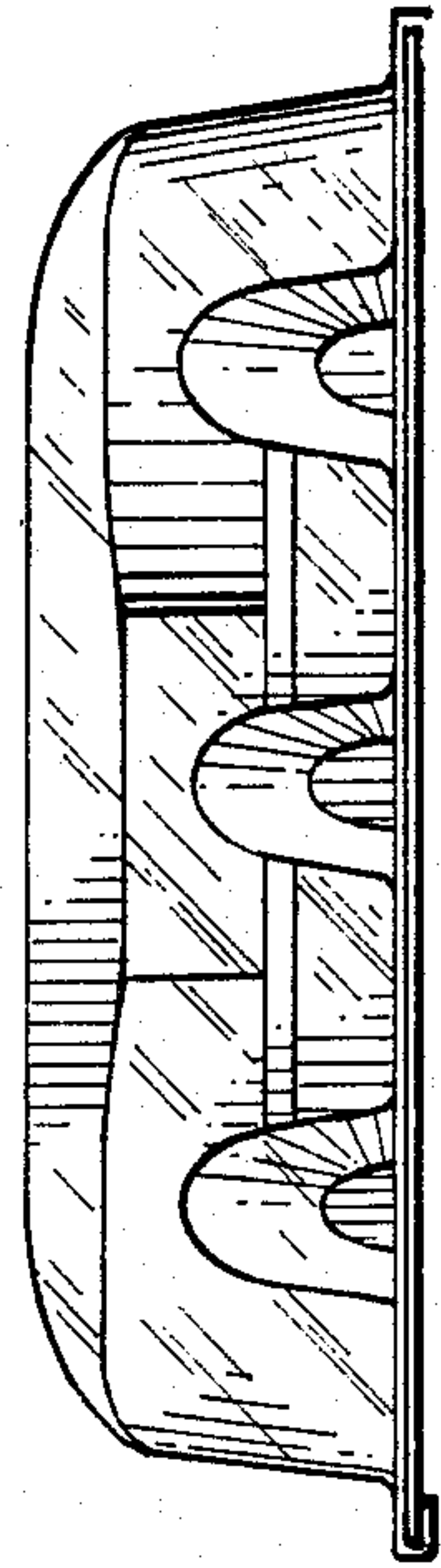

FIG. 3

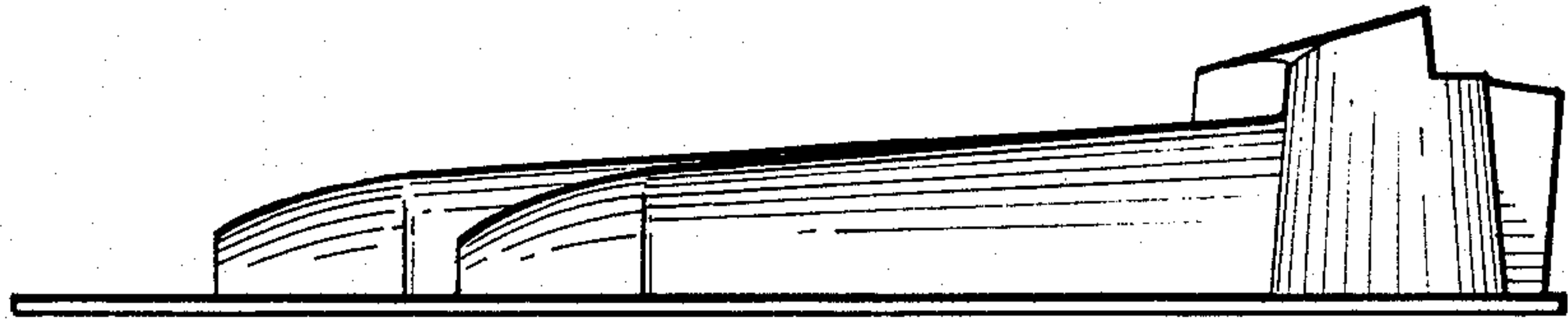

FIG. 2

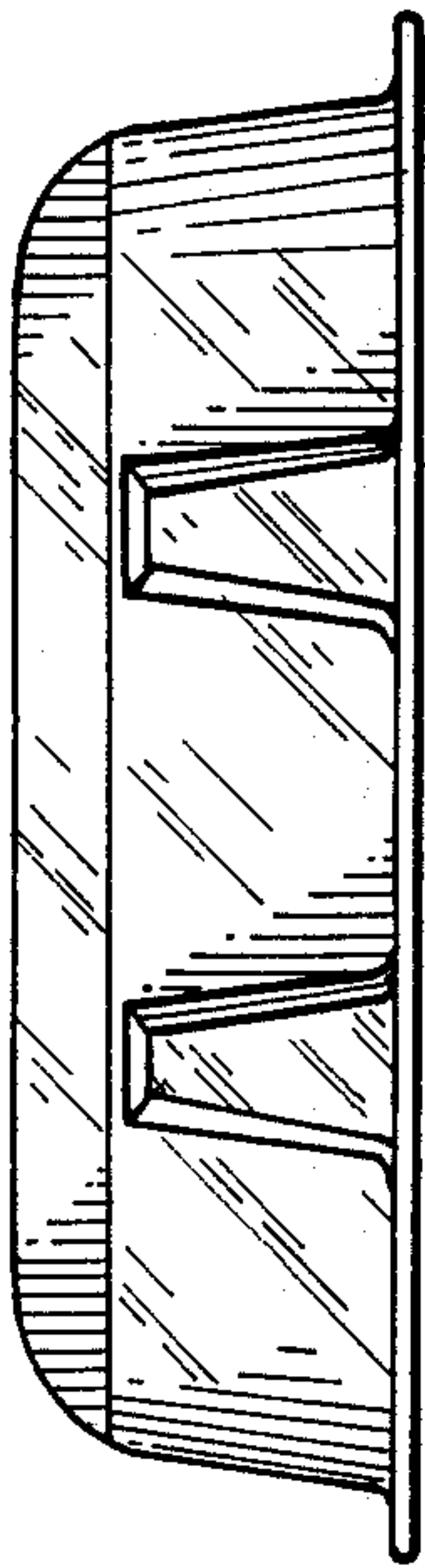

FIG. 5

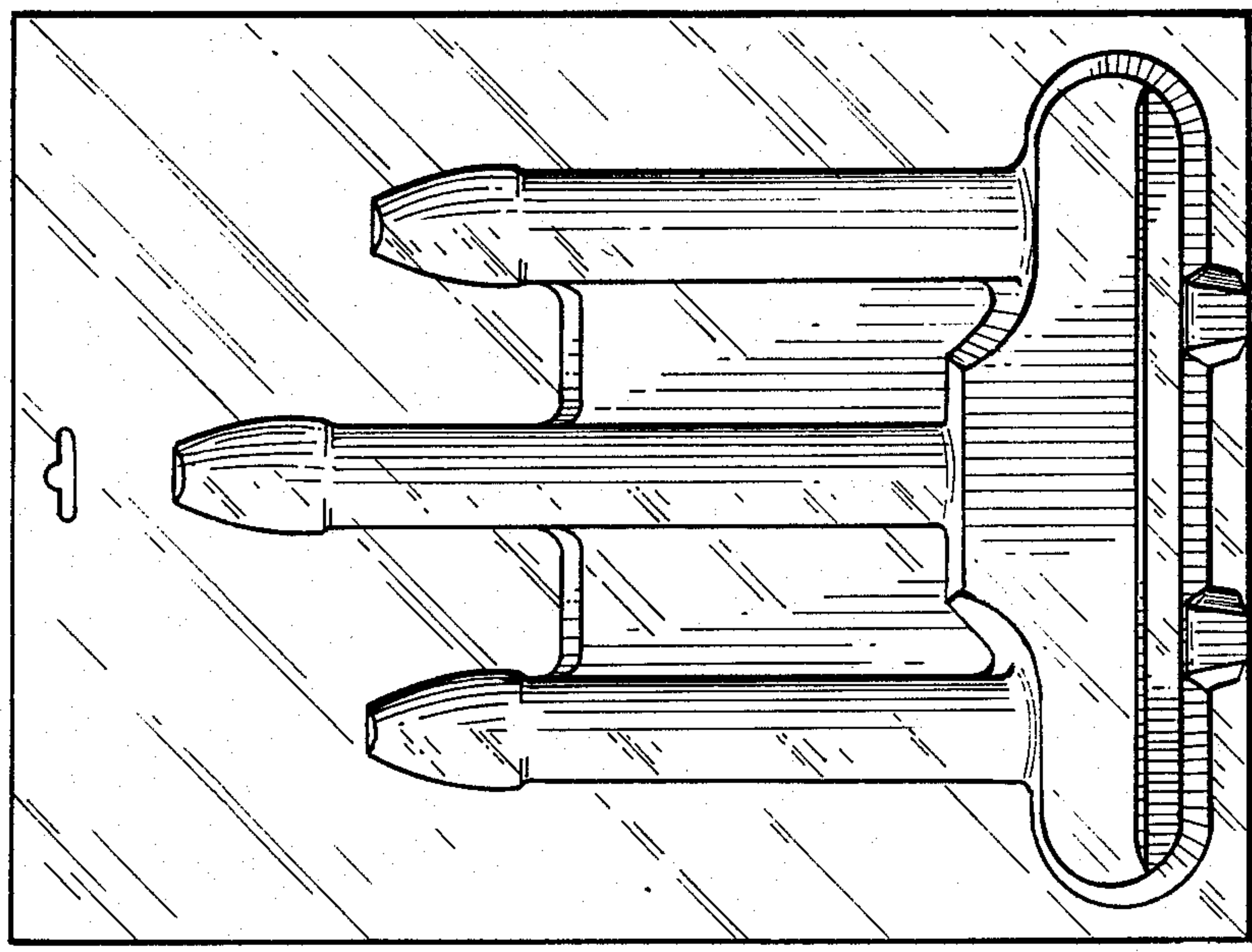

FIG. 1

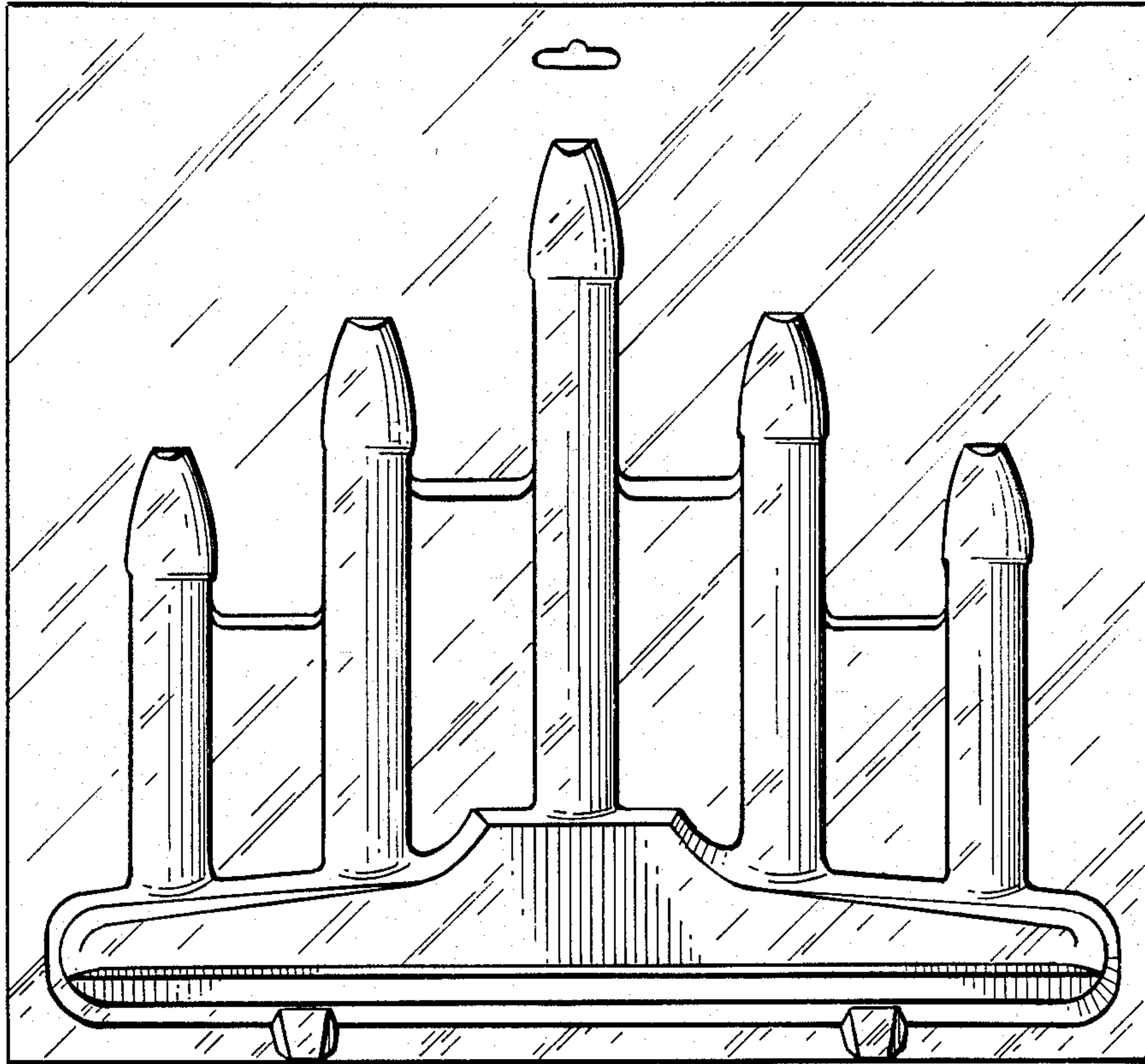

FIG. 6

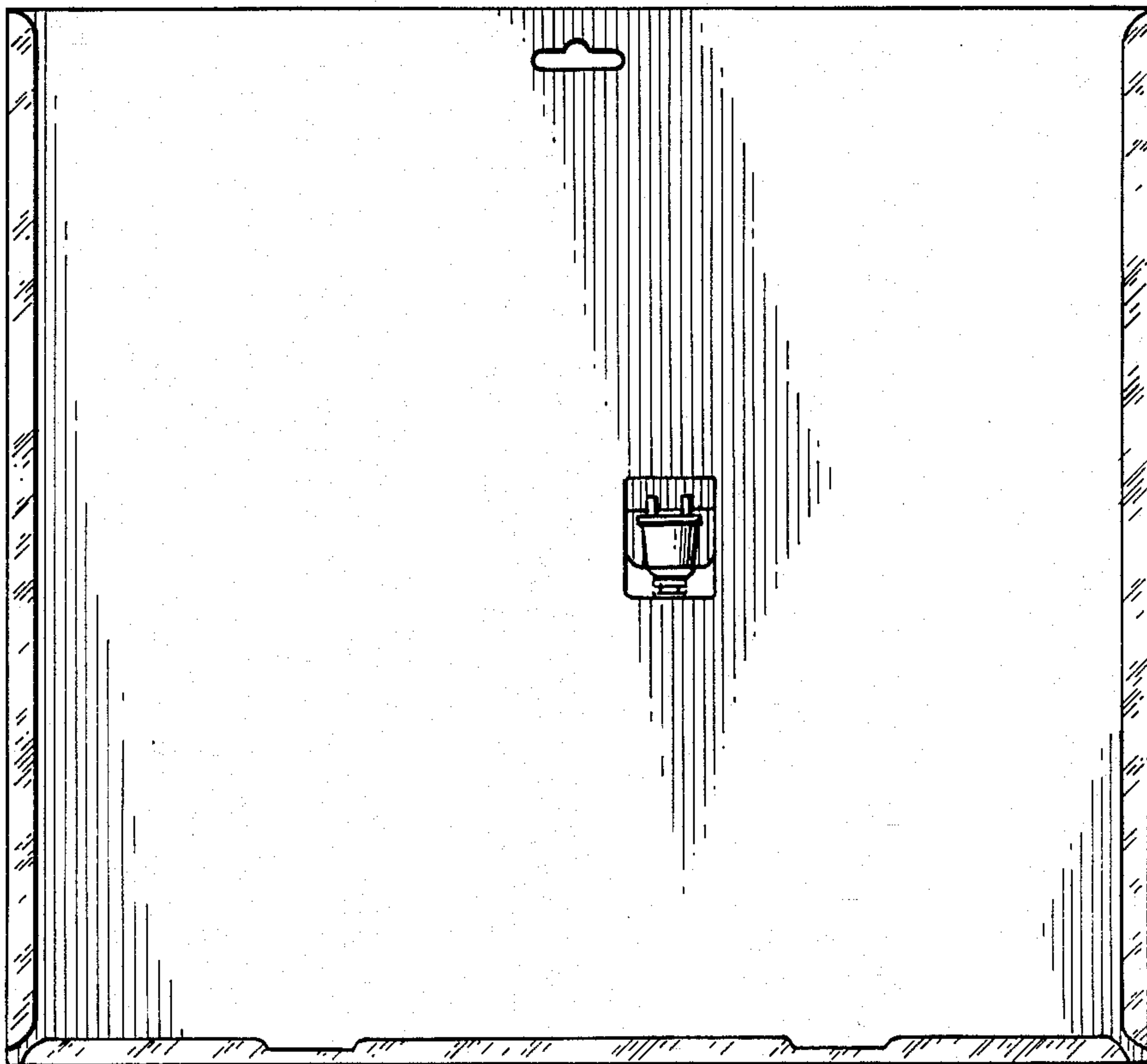

FIG. 7



FIG. 8

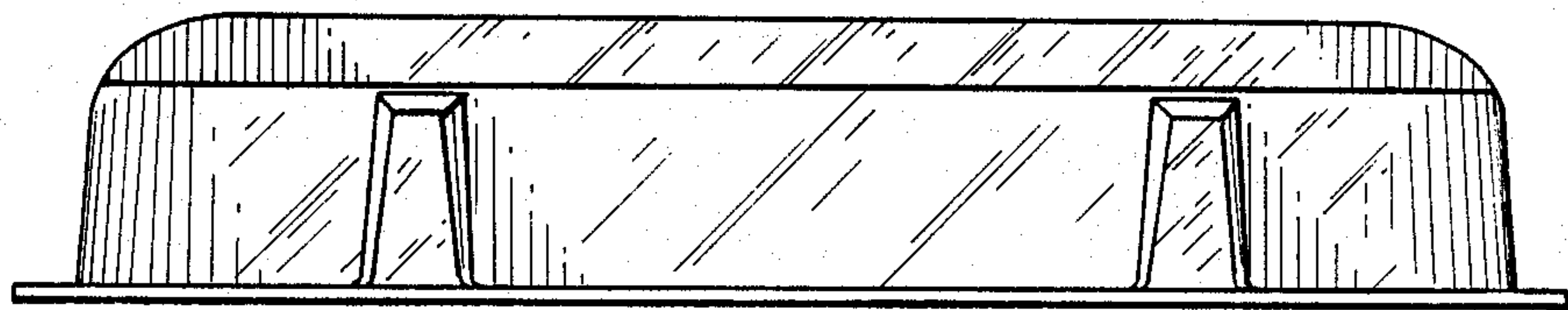

FIG. 9

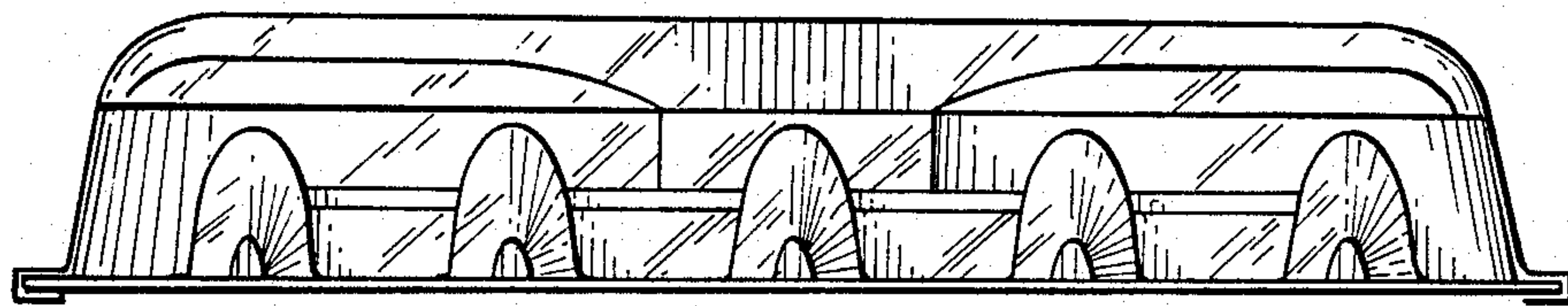

FIG. 10