

[54] COMBINATION COASTER SET,
CORKSCREW AND BOTTLE OPENER

[75] Inventor: Siegfried Hölterscheidt,
Hückelhoven, Fed. Rep. of Germany

[73] Assignee: Walter Henkels GmbH, Fed. Rep. of
Germany

[**] Term: 14 Years

[21] Appl. No.: 851,403

[22] Filed: Apr. 10, 1986

[30] Foreign Application Priority Data

Jan. 6, 1986 [DE] Fed. Rep. of Germany MR 165

[52] U.S. Cl. D7/45; D8/34

[58] Field of Search D7/45; D8/34, 40, 42-43;
81/3.09, 3.55, 3.48; 215/100.5; 220/85 H;
248/346.1

[56] References Cited

U.S. PATENT DOCUMENTS

D. 162,258 2/1951 Sturm D7/45
D. 236,576 9/1975 Press D7/45

OTHER PUBLICATIONS

Gift & Tableware Reporter, 8/76 Sec. 2, p. 16, Cork-
screw #2.

Primary Examiner—Bernard Ansher
Assistant Examiner—Terry Pfeffer
Attorney, Agent, or Firm—Diller, Ramik & Wight

[57] CLAIM

The ornamental design for a combination coaster set,
corkscrew and bottle opener, as shown and described.

DESCRIPTION

FIG. 1 is an exploded perspective view of a combina-
tion coaster set, corkscrew and bottle opener showing
my new design;

FIG. 2 is a top plan view of the coaster;

FIG. 3 is a front elevational view of the corkscrew and
bottle opener;

FIG. 4 is a front elevational view of the corkscrew and
bottle opener in a user position;

FIG. 5 is a front elevational view thereof;

FIG. 6 is a top plan view thereof;

FIG. 7 is a left-side elevational view thereof;

FIG. 8 is a right-side elevational view thereof;

FIG. 9 is a bottom plan view thereof; and

FIG. 10 is a top plan view of the corkscrew in a user
position, the bottle being shown in broken lines for
illustrative purposes only.

FIGS. 3, 4 and 5 of the claimed design are shown sepa-
rately for clarity of illustration.

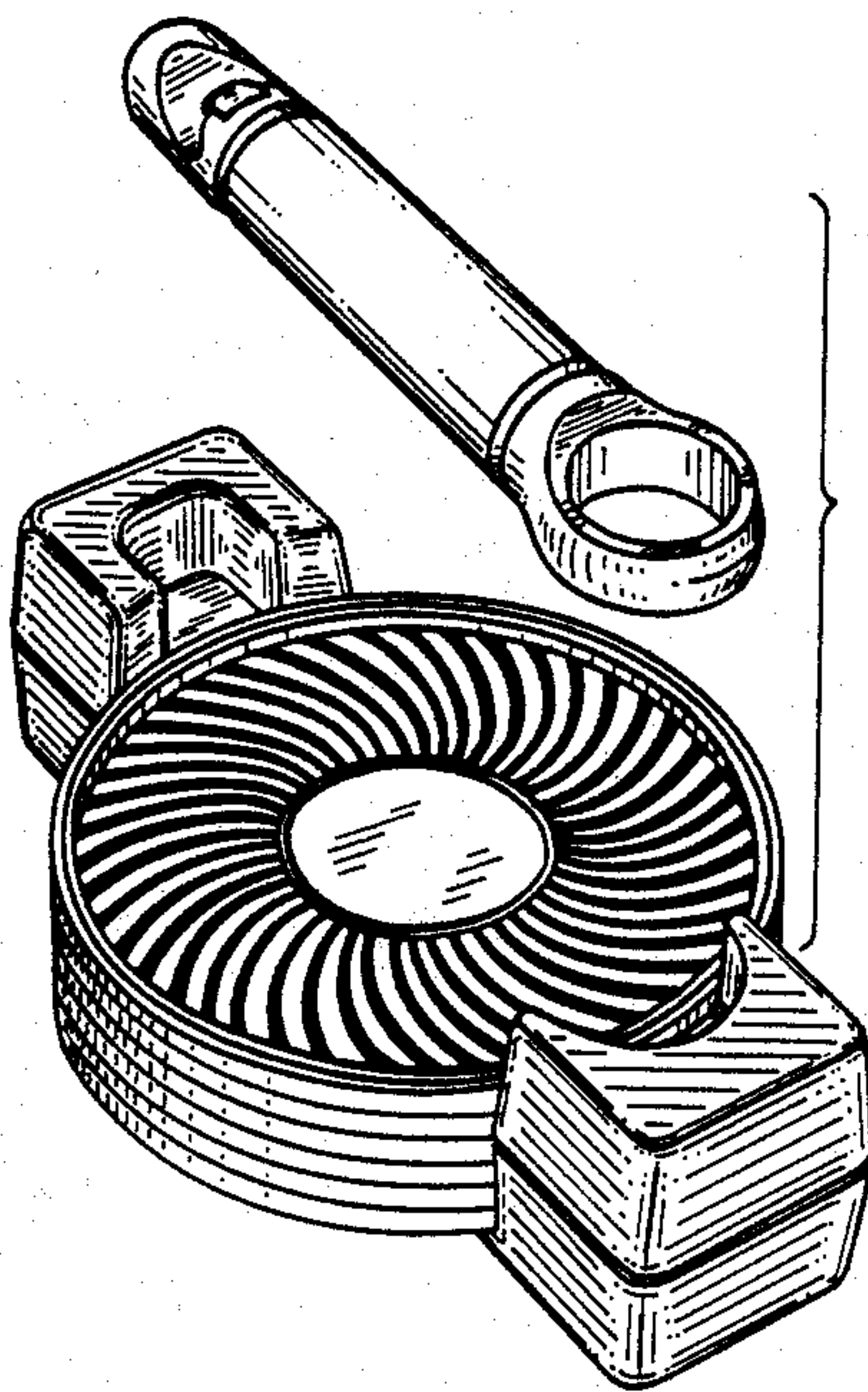

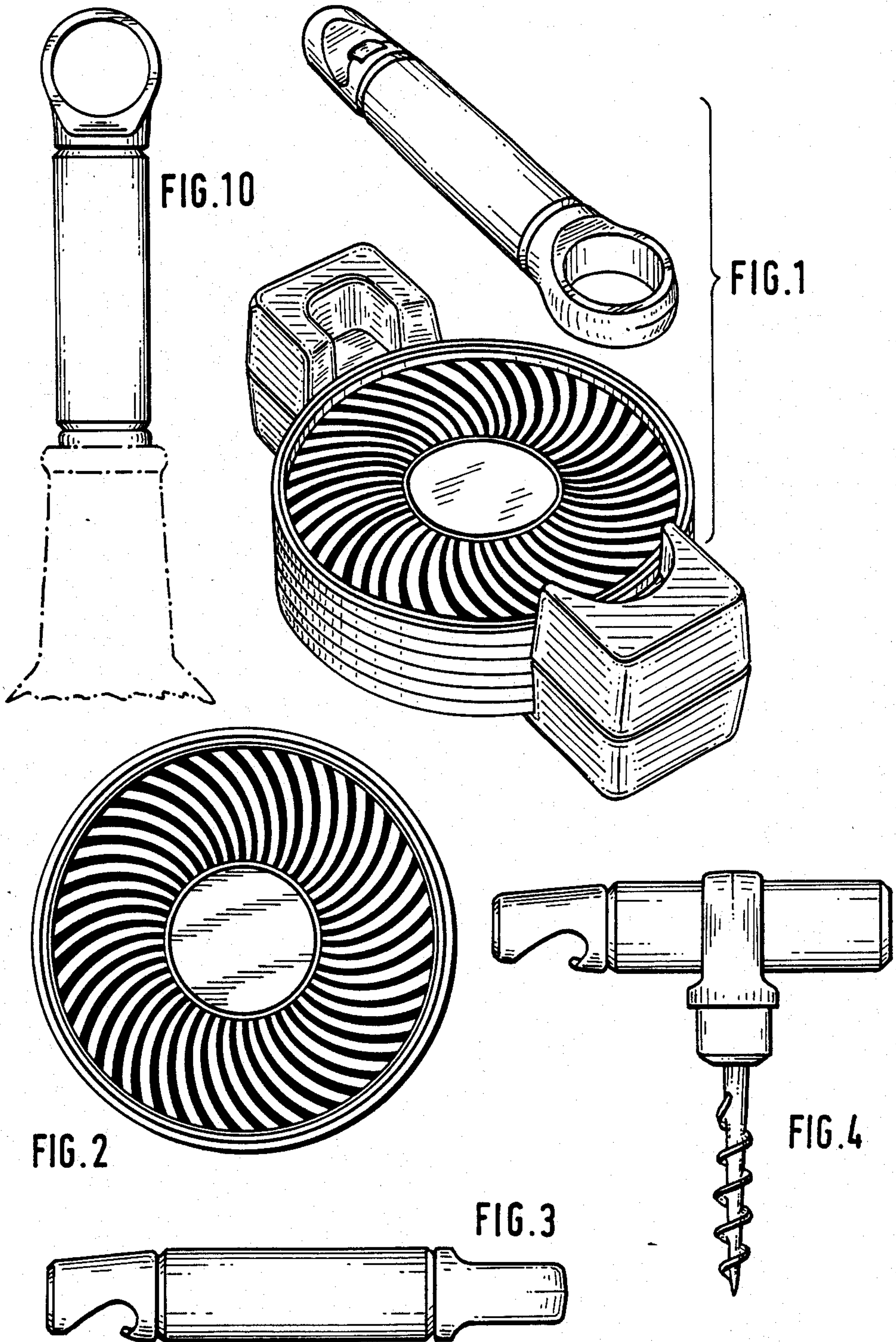

FIG. 5

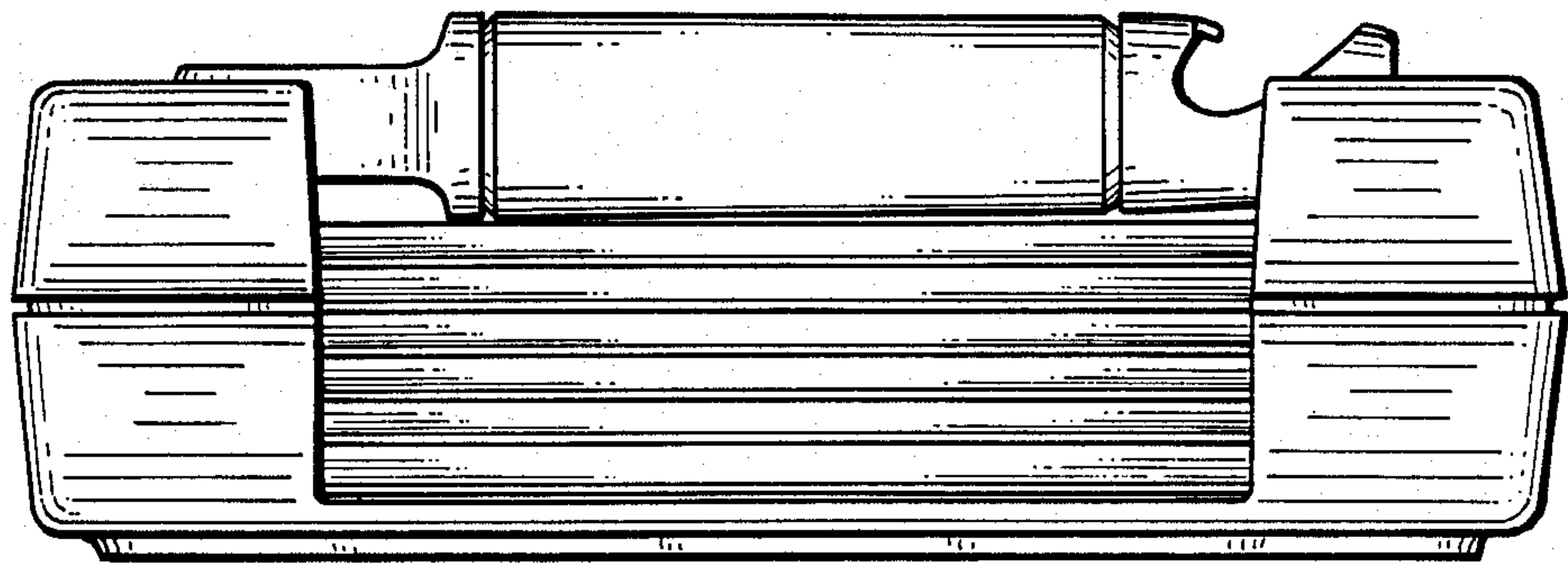
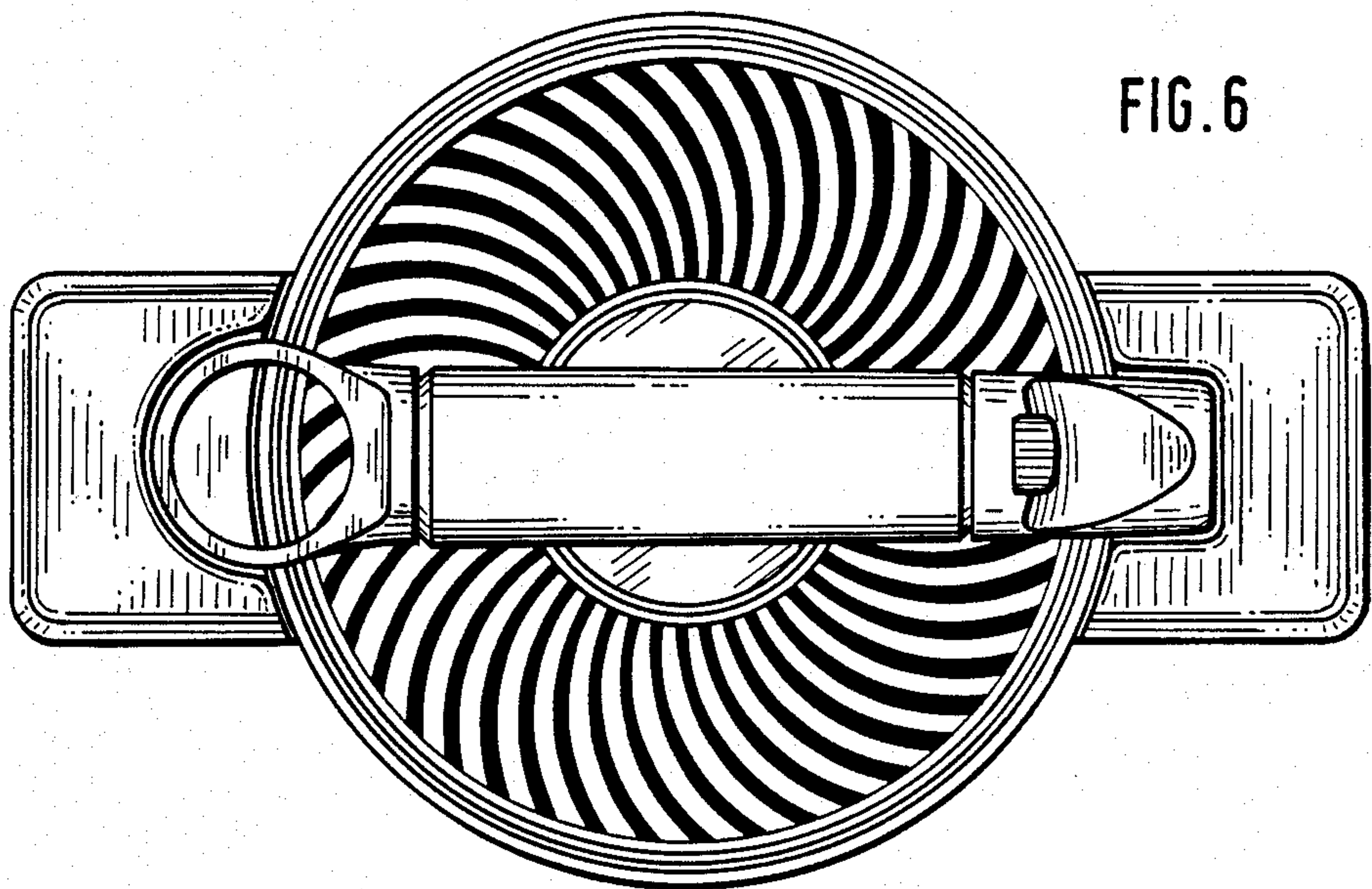

FIG. 6



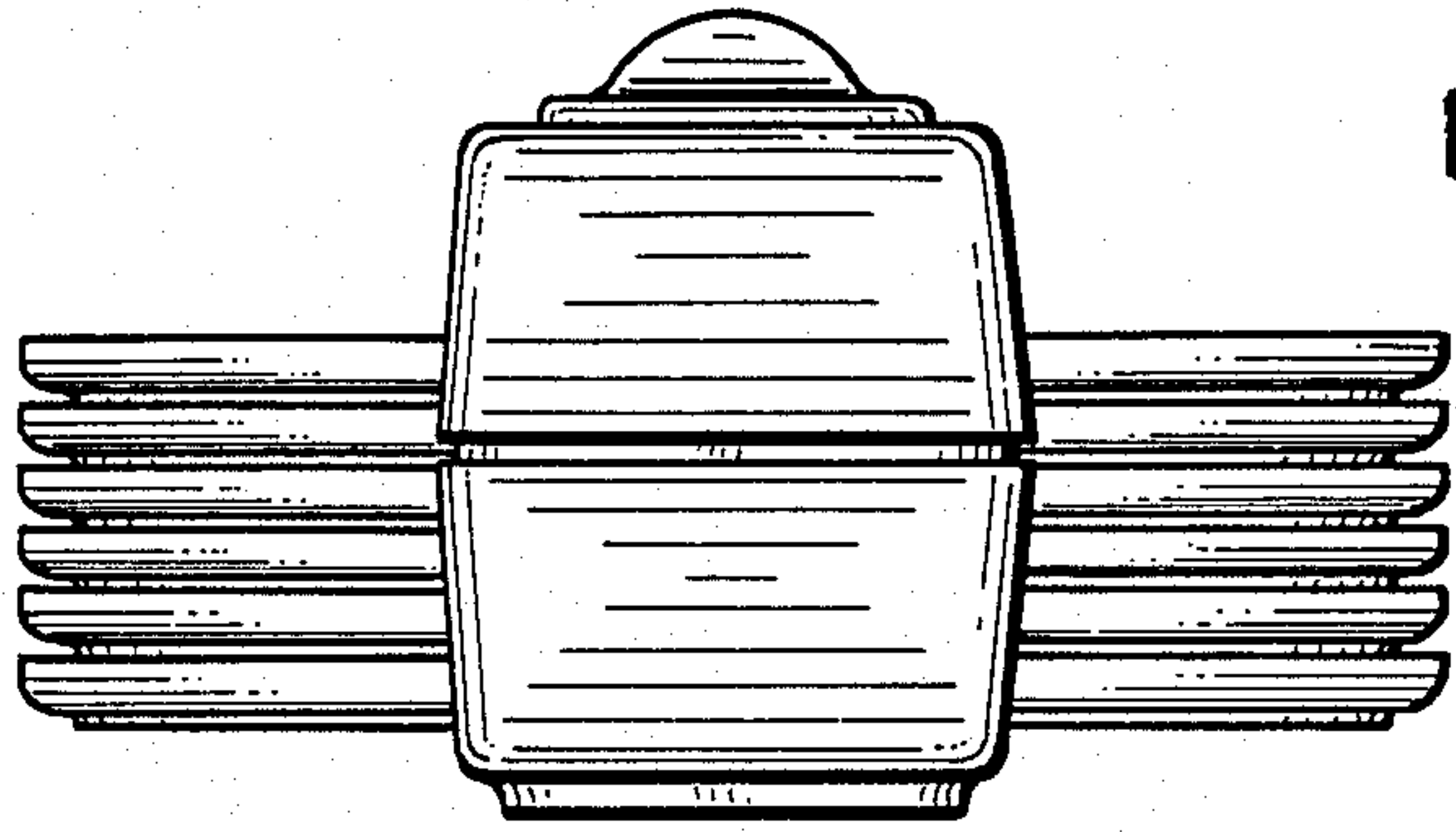

FIG. 7

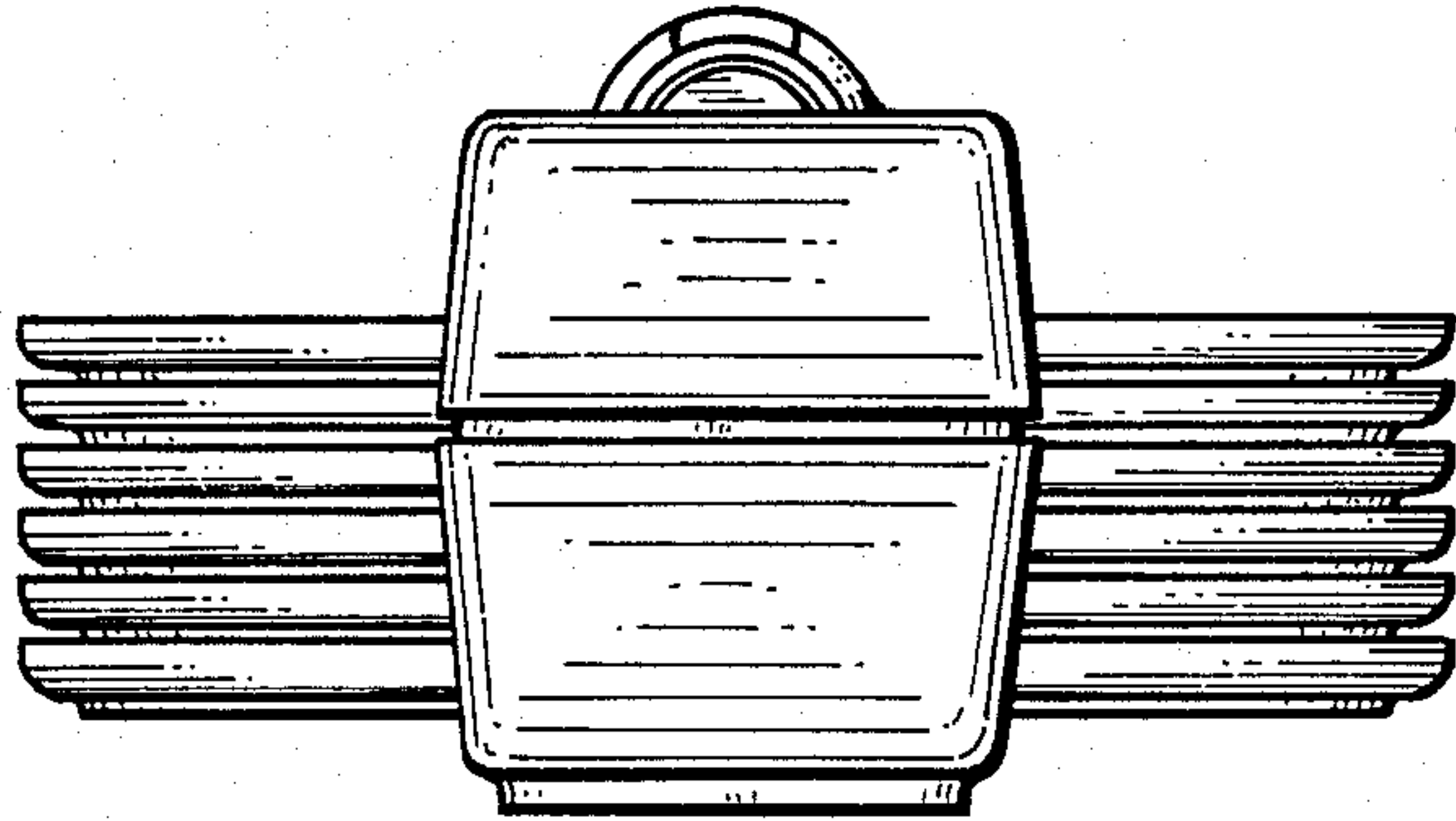

FIG. 8

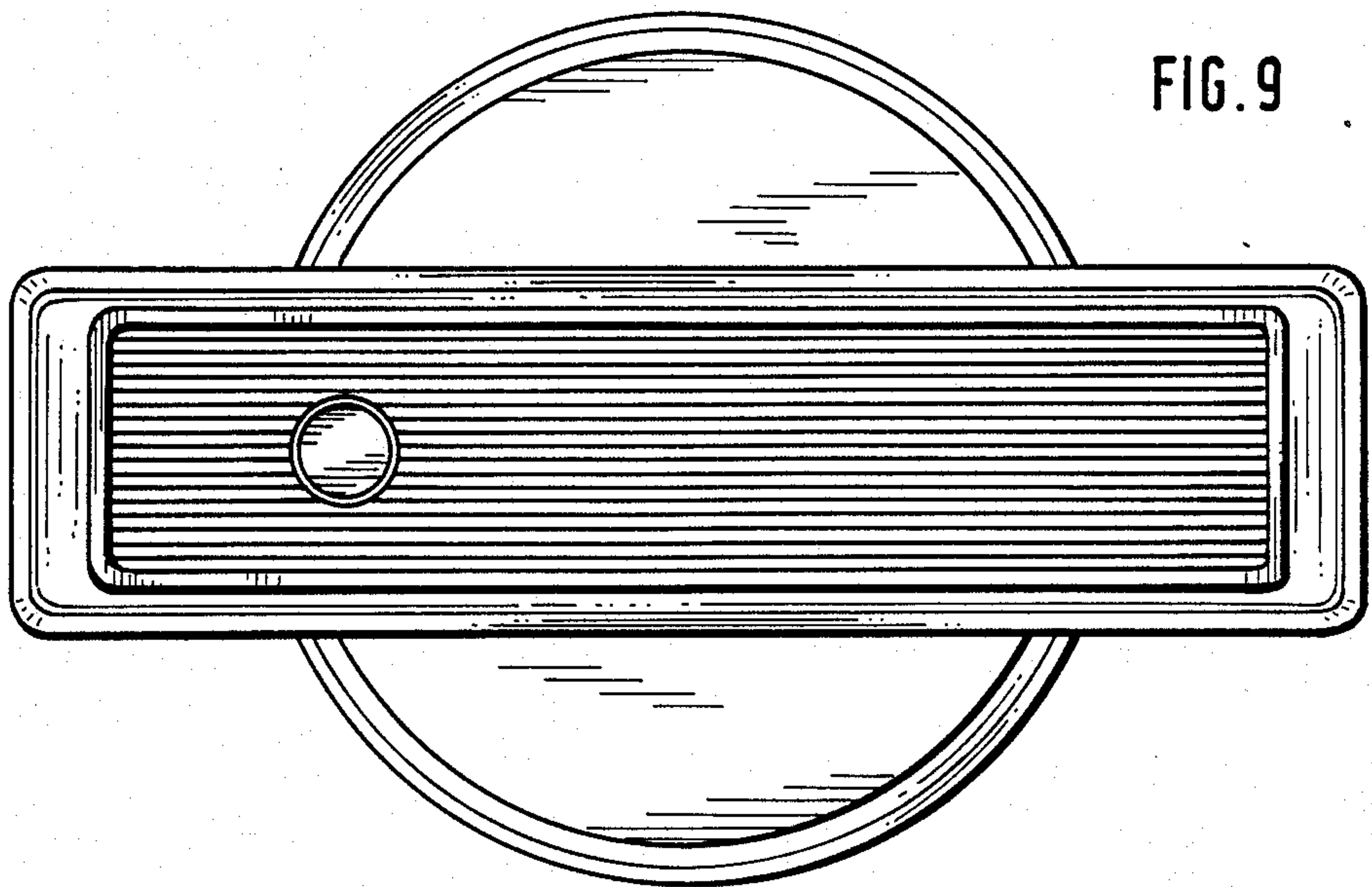

FIG. 9