

[54] COMBINED COPYING MACHINE AND ELECTRONIC COMPUTER

[75] Inventor: Kunio Hara, Chiba, Japan

[73] Assignee: Kabushiki Kaisha Toshiba, Kawasaki, Japan

[**] Term: 14 Years

[21] Appl. No.: 903,436

[22] Filed: Sep. 4, 1986

[30] Foreign Application Priority Data

Mar. 13, 1986 [JP] Japan 61-8789

[52] U.S. Cl. D14/100; D18/36

[58] Field of Search D14/100, 102, 106, 107, D14/113, 114, 115; D16/30, 31, 27; 358/254, 249; D18/1; 355/3 R, 9, 11, 14 R

[56] References Cited

U.S. PATENT DOCUMENTS

- D. 290,845 7/1987 Yubisui et al. D18/1 X
- D. 295,285 4/1988 Nishibori D16/30
- D. 296,334 6/1988 Hara D14/107 X
- 4,327,994 5/1982 Barley et al. 355/14 R
- 4,736,332 4/1988 Crease 364/708

FOREIGN PATENT DOCUMENTS

3202046 7/1983 Fed. Rep. of Germany 358/254

OTHER PUBLICATIONS

"Buyers Guide", 1983, p. 80, Datacopy 700 Peripheral (bottom left Peripheral).

Primary Examiner—Susan J. Lucas
Assistant Examiner—Freda S. Nunn
Attorney, Agent, or Firm—Oblon, Fisher, Spivak, McClelland & Maier

[57] CLAIM

The ornamental design for a combined copying machine and electronic computer, as shown and described.

DESCRIPTION

FIG. 1 is a top, front and right side perspective view of combined copying machine and electronic computer showing my new design;
FIG. 2 is a perspective view like FIG. 1 with the cover opened;
FIG. 3 is a front elevational view thereof;
FIG. 4 is a right side elevational view thereof;
FIG. 5 is a top plan view thereof;
FIG. 6 is a left side elevational view thereof;
FIG. 7 is a rear elevational view thereof; and
FIG. 8 is a bottom plan view thereof.

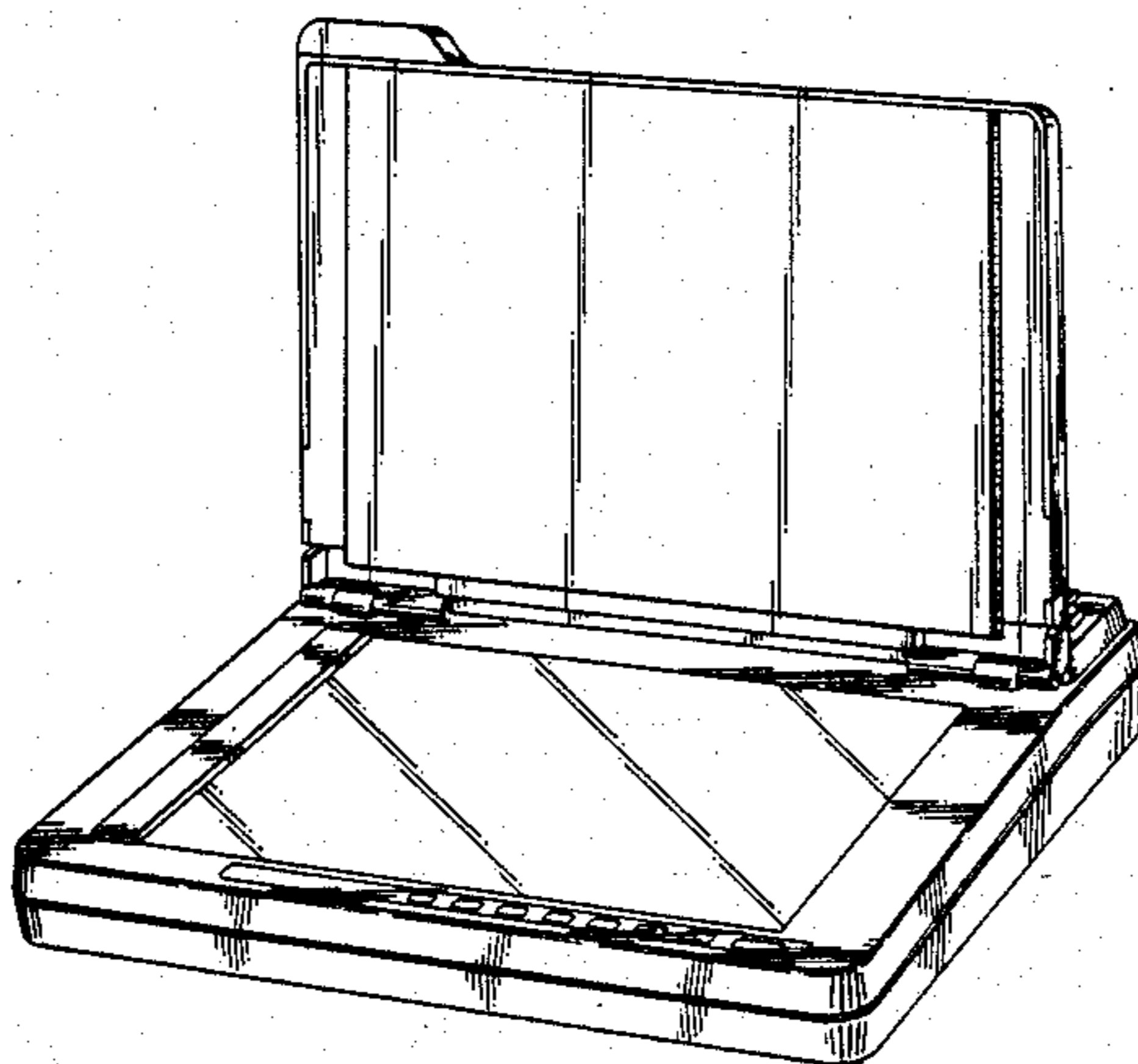
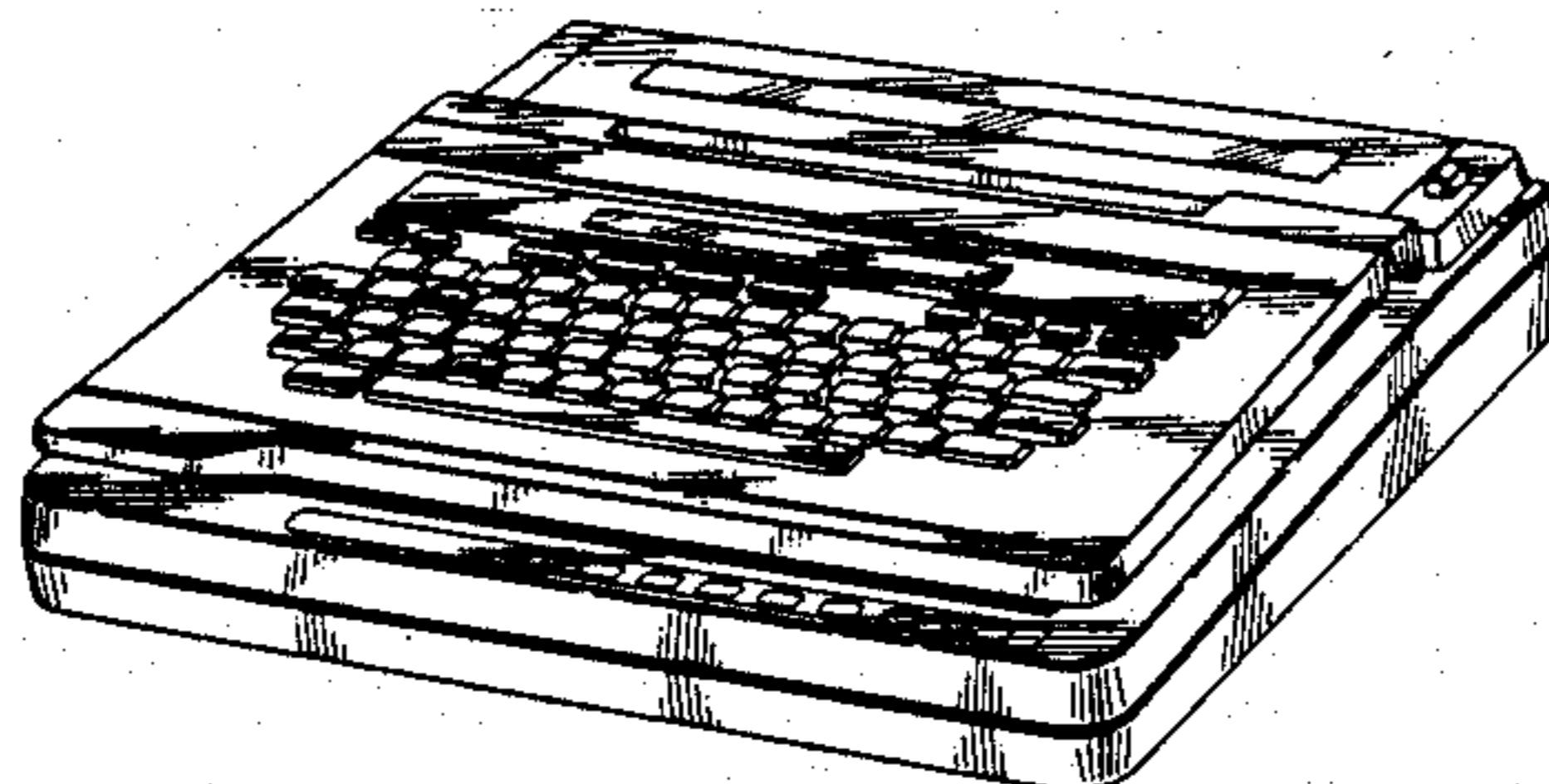

FIG. 1

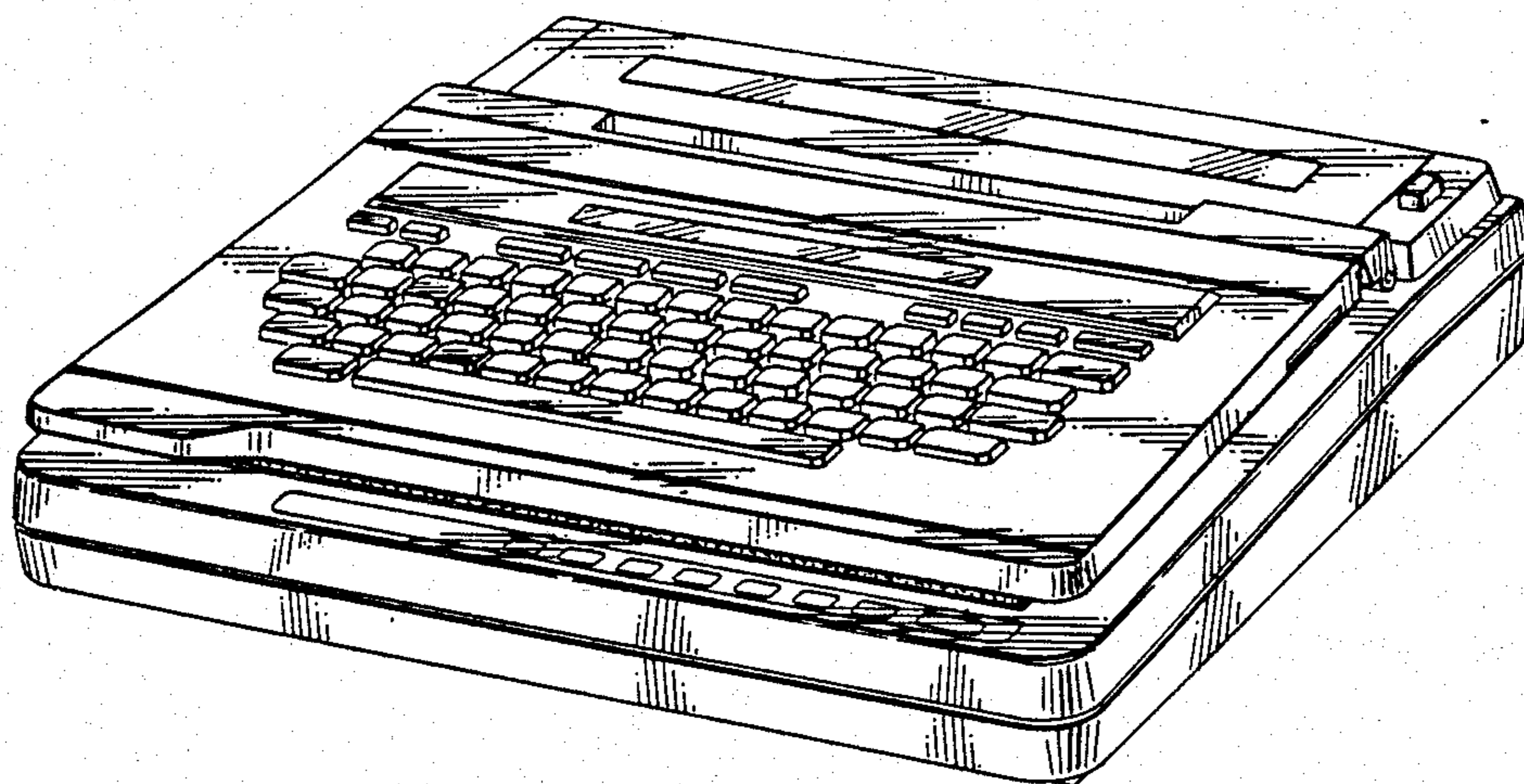

FIG. 2

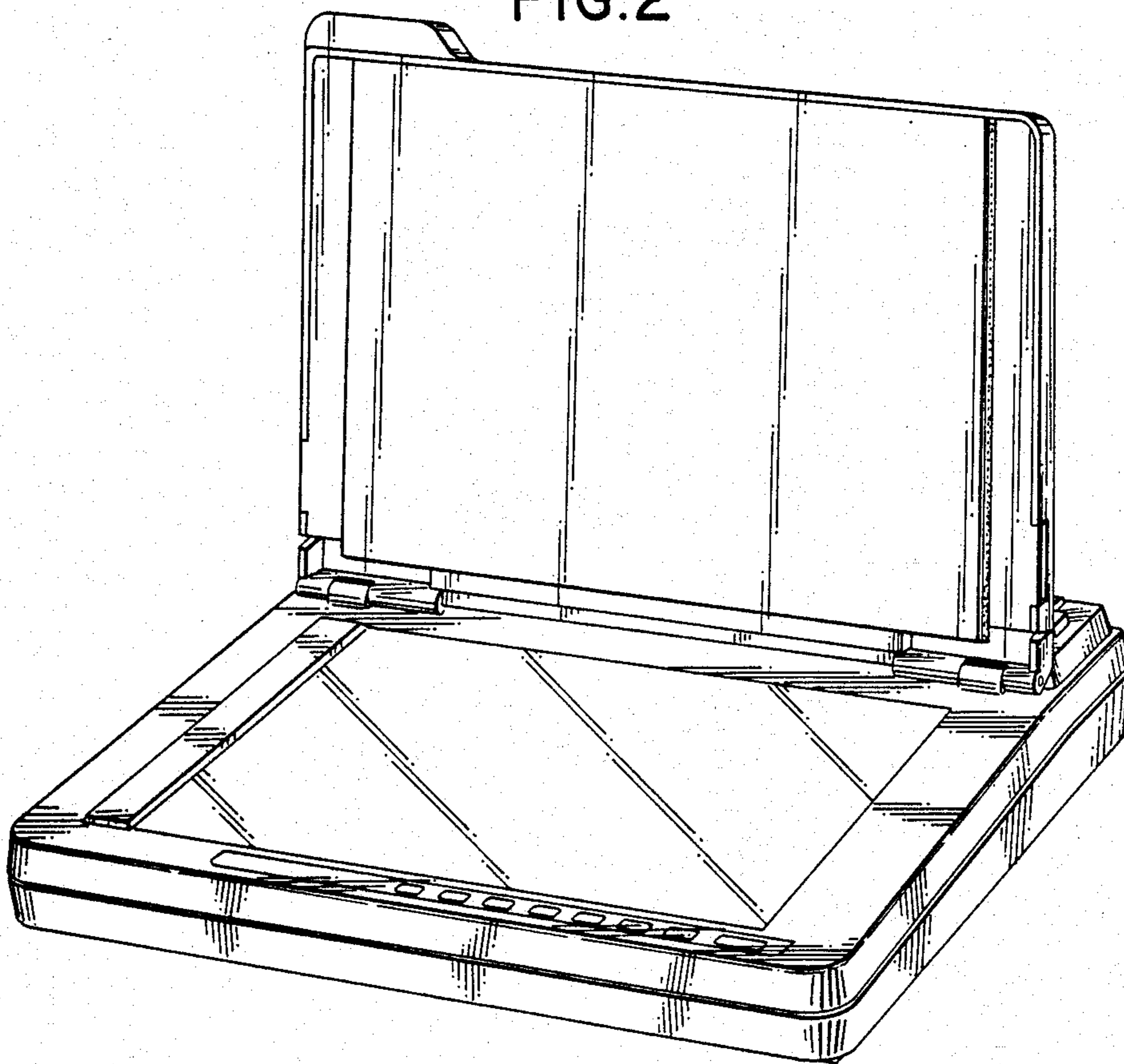

FIG. 3

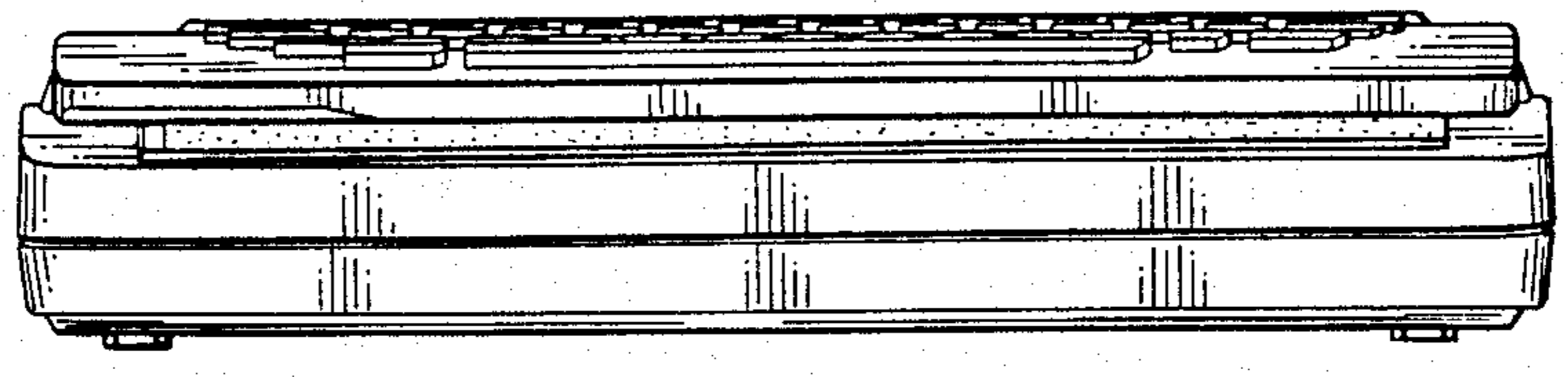

FIG. 4

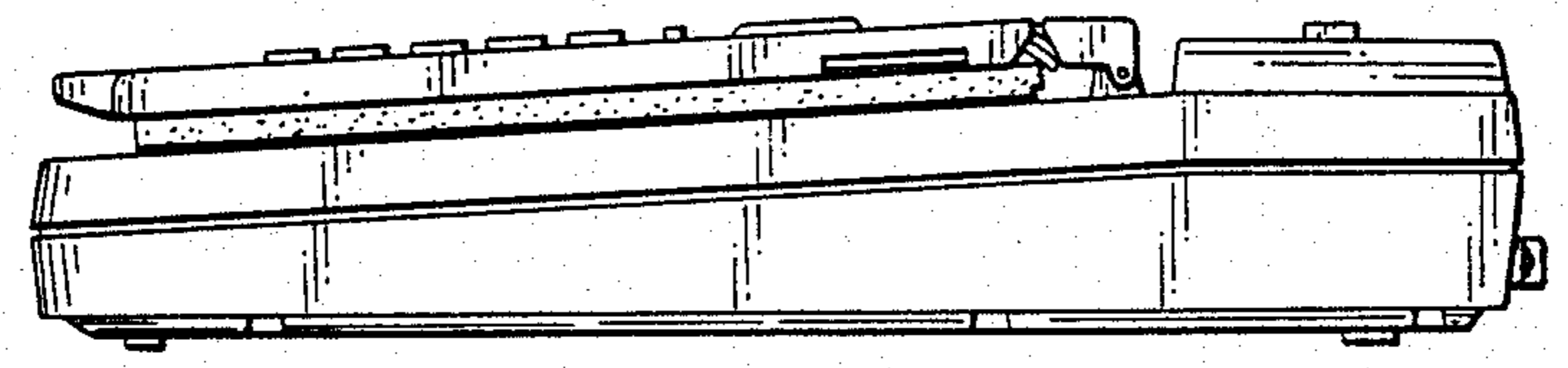

FIG. 5

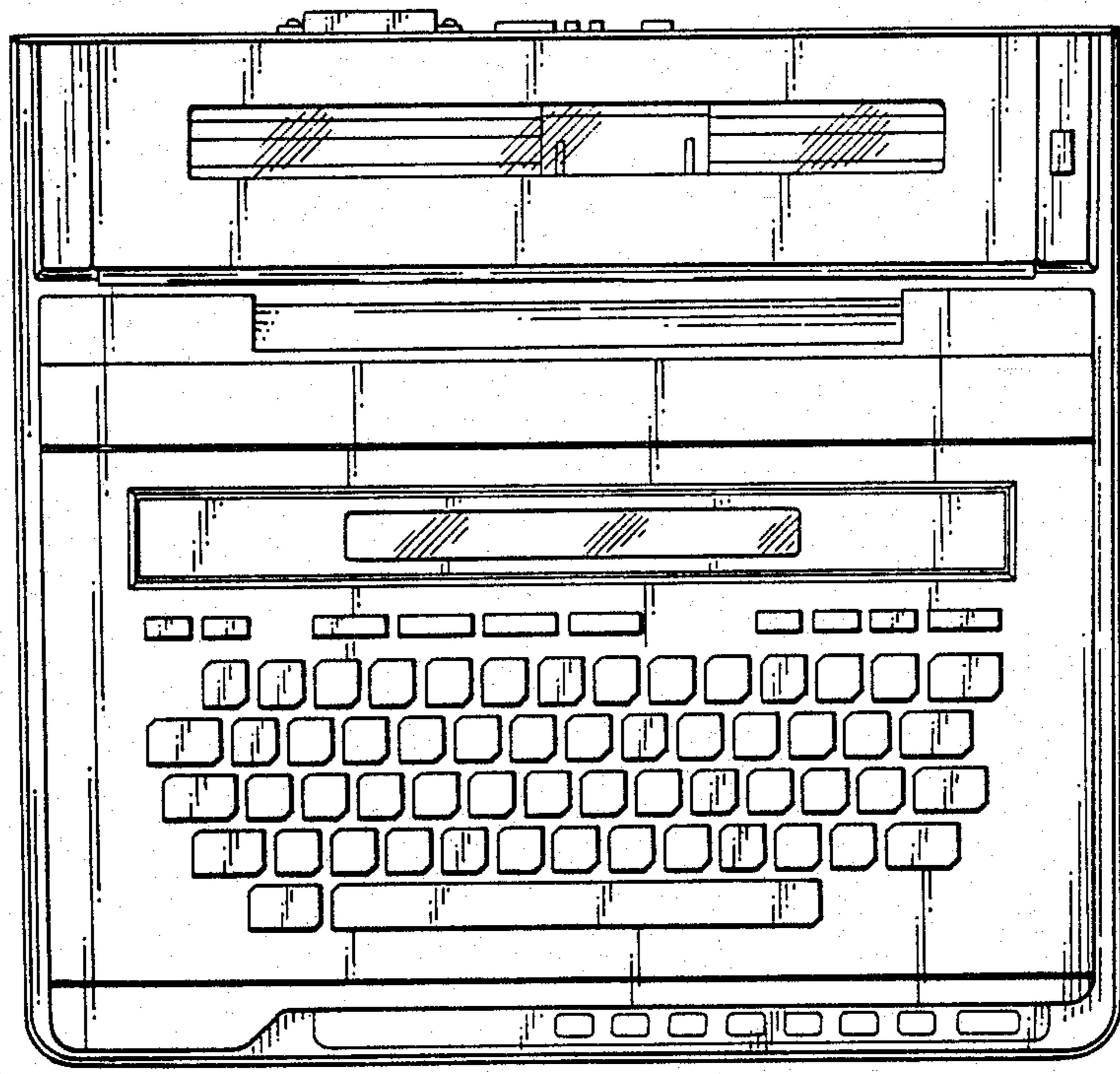

FIG. 6

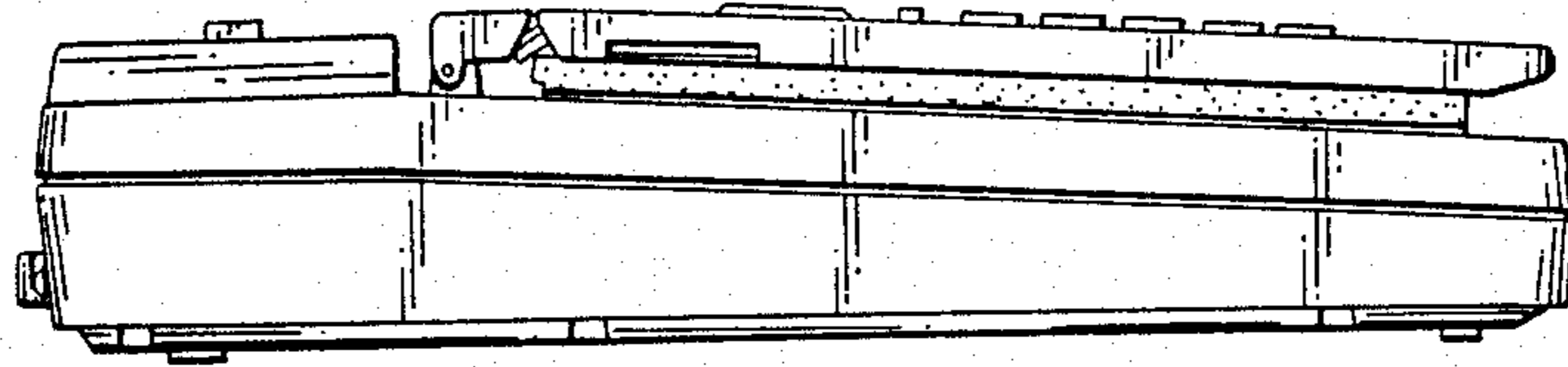

FIG. 7

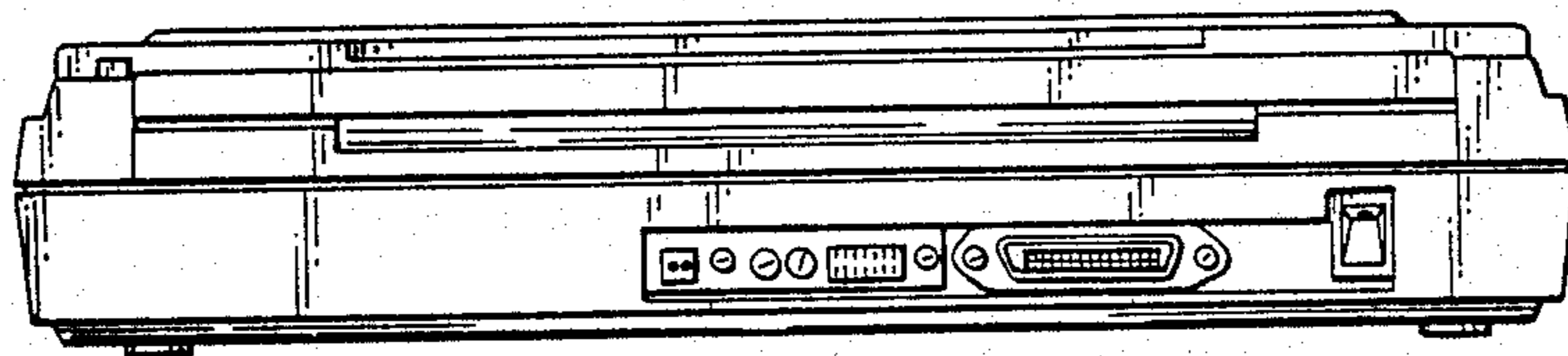

FIG. 8

