

[54] COMBINED TOOTHBRUSH AND CONTAINER THEREFOR

[76] Inventor: Emilio Ambasz, 295, Central Park West, New York, N.Y. 10024

[**] Term: 14 Years

[21] Appl. No.: 139,431

[22] Filed: Dec. 30, 1987

[52] U.S. Cl. D4/108

[58] Field of Search D4/100-114; D24/10-11; 15/106, 110, 159 R, 159 A, 160, 167, 1-167.2, 172, 176.1-176.6, 184-185; 132/84 R, 84 A-84 D; 206/361-362.3

[56] References Cited

U.S. PATENT DOCUMENTS

D. 286,467	11/1986	Berghash	D4/108
1,052,539	2/1913	Welch	15/185
2,083,728	6/1937	Mayer	15/176.1 X
2,112,658	3/1938	Rathbun	15/167.1 X
2,657,412	11/1953	Carlson	15/167.1 X
2,673,641	3/1954	Carrillo	132/84 R
2,678,459	5/1954	Stuckey	15/185

FOREIGN PATENT DOCUMENTS

54-119770	8/1979	Japan .
62-67504	4/1987	Japan .

Primary Examiner—Wallace R. Burke
Assistant Examiner—Lavone D. Tabor
Attorney, Agent, or Firm—Ostrolenk, Faber, Gerb & Soffen

[57] CLAIM

The ornamental design for a combined toothbrush and container therefor, as shown and described.

DESCRIPTION

FIG. 1 is a perspective view of a combined toothbrush and container therefor embodying my new design; FIG. 2 is a front side elevational view thereof; FIG. 3 is a rear side elevational view thereof; FIG. 4 is a top plan view thereof; FIG. 5 is a bottom plan view thereof; FIG. 6 is a left end elevational view thereof; FIG. 7 is a right end elevational view thereof; FIG. 8 is a perspective view thereof, the container type handle shown in partially open condition; FIG. 9 is a perspective view thereof, shown with the toothbrush enclosed in the container portion; FIG. 10 is a front side elevational view thereof; FIG. 11 is a rear side elevational view thereof; FIG. 12 is a top plan view thereof; FIG. 13 is a bottom plan view thereof; FIG. 14 is a left end elevational view thereof; and FIG. 15 is a right end elevational view thereof.

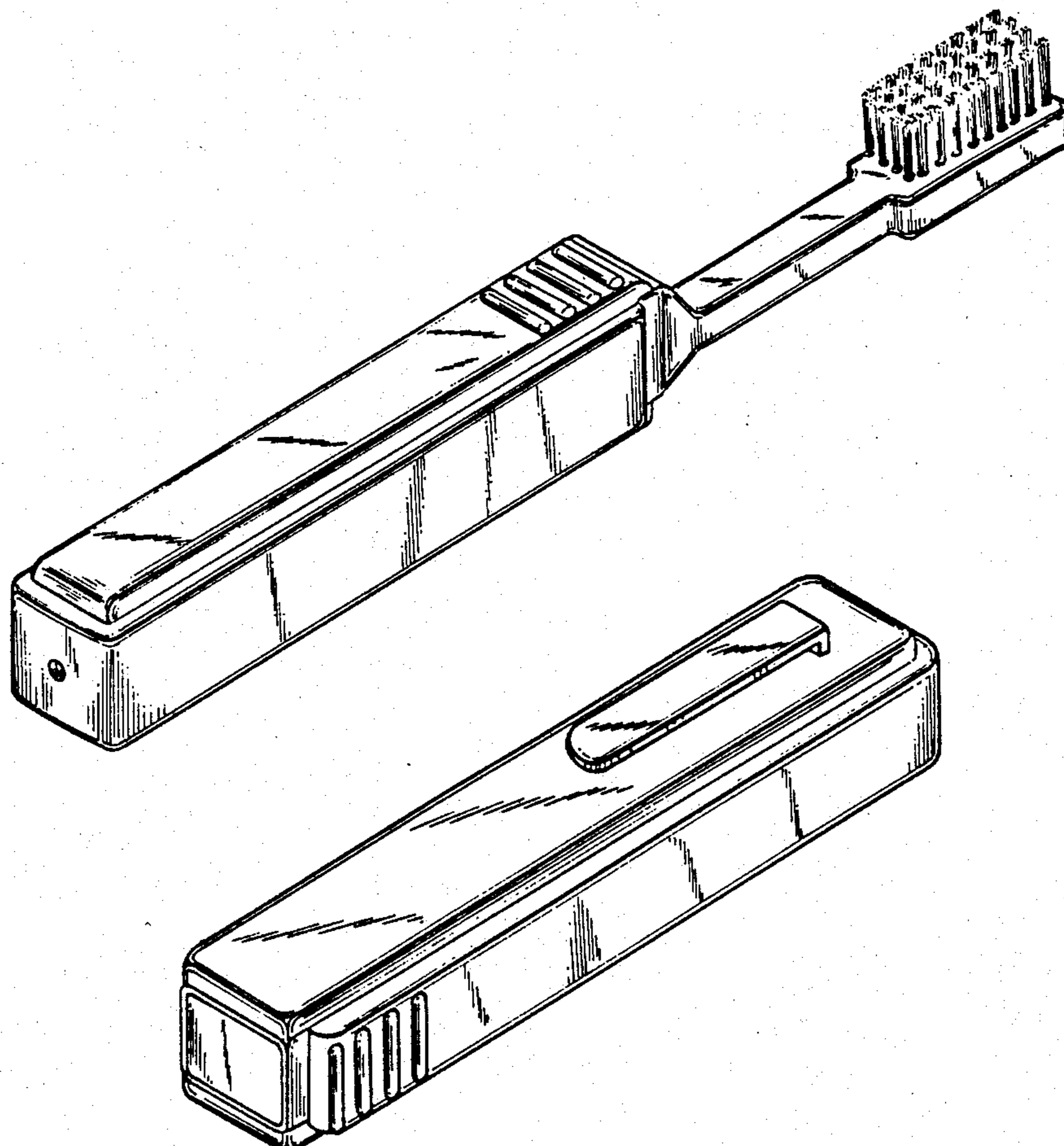

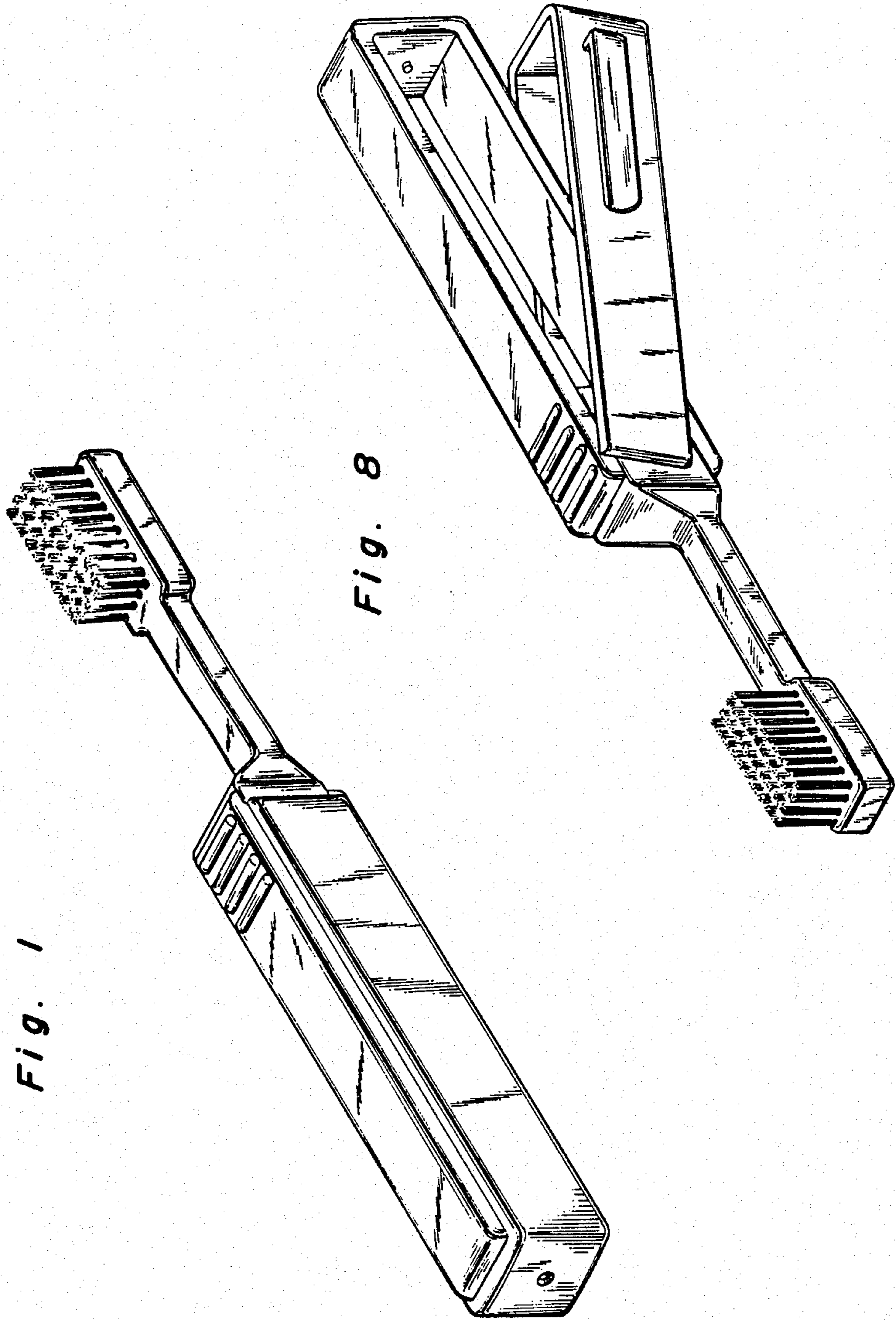

Fig. 1

Fig. 8

Fig. 2

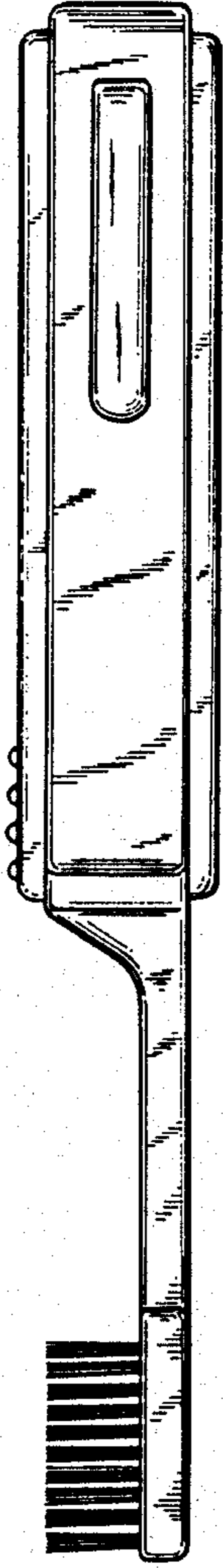

Fig. 3

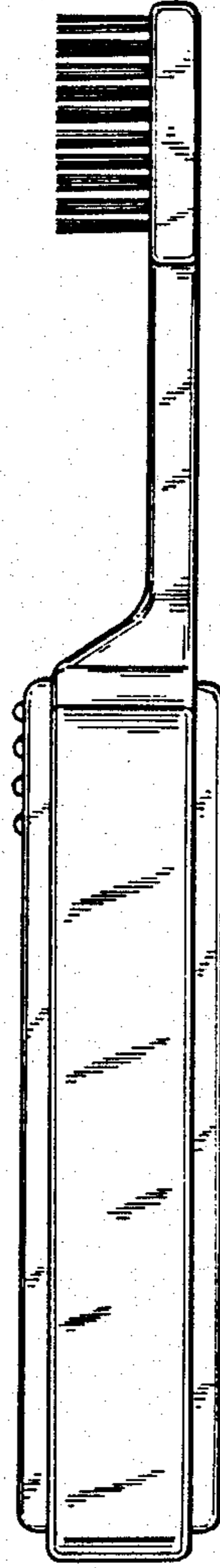

Fig. 4

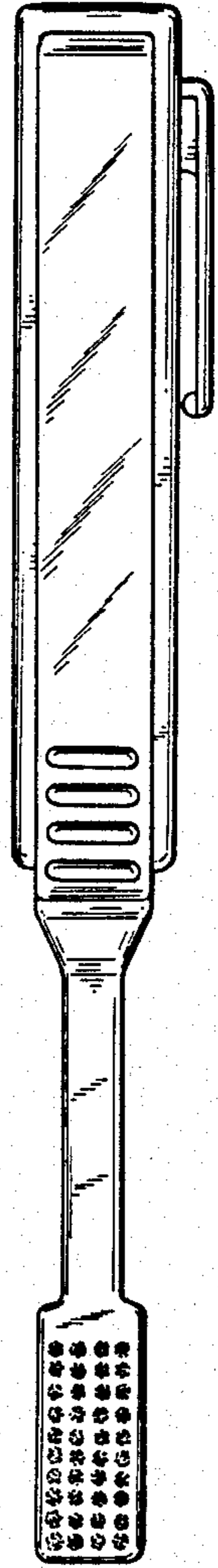

Fig. 5

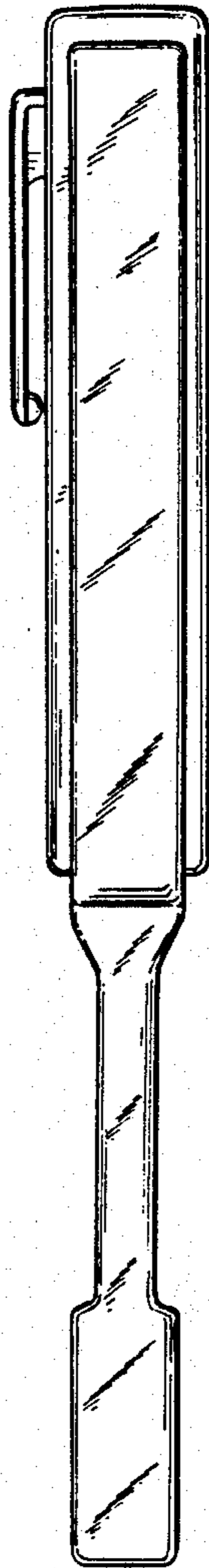

Fig. 6



Fig. 7

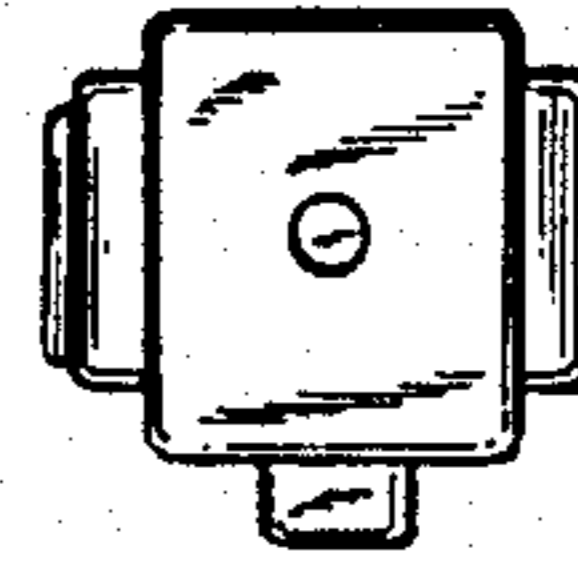

Fig. 9

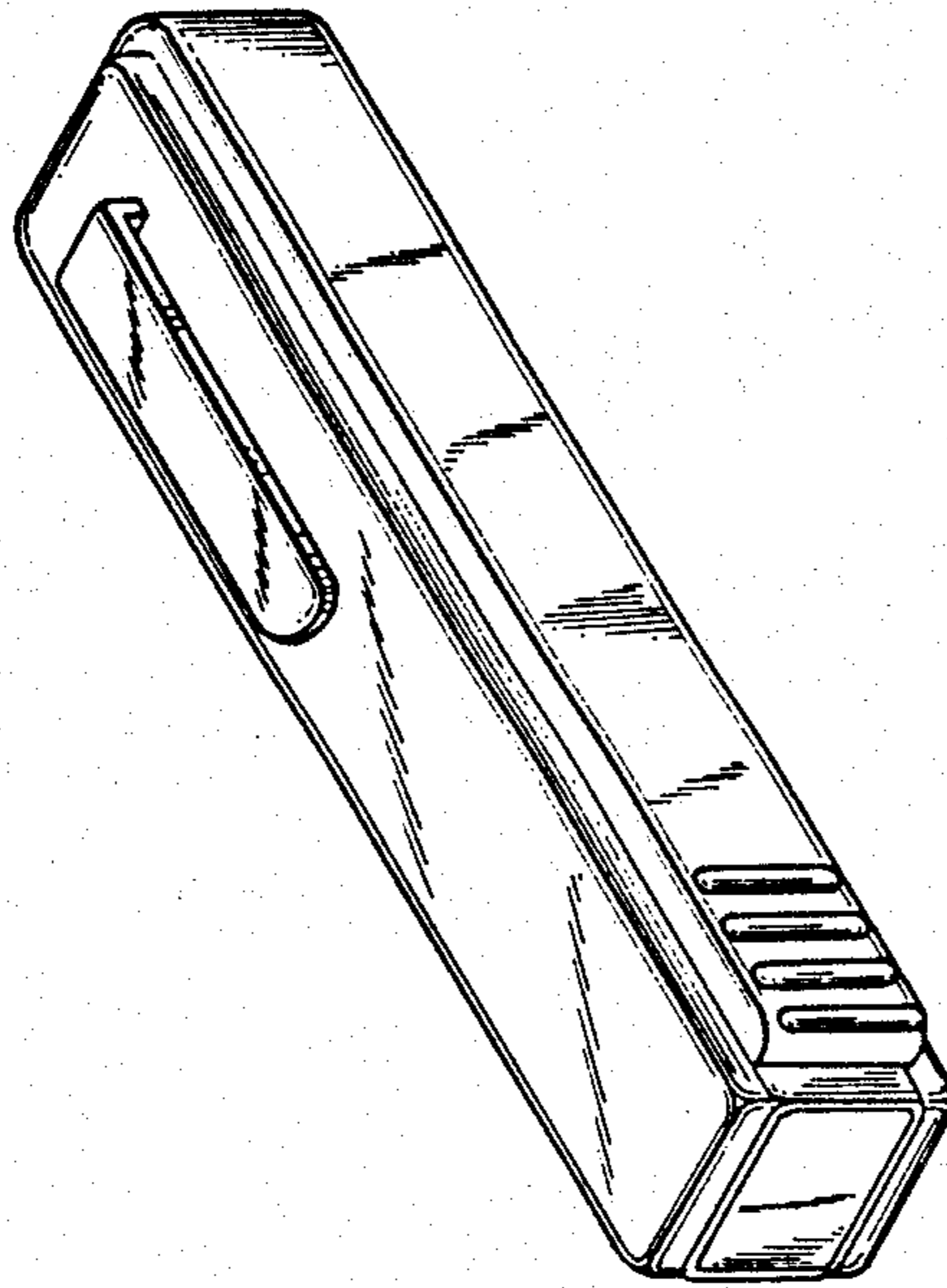

Fig. 14

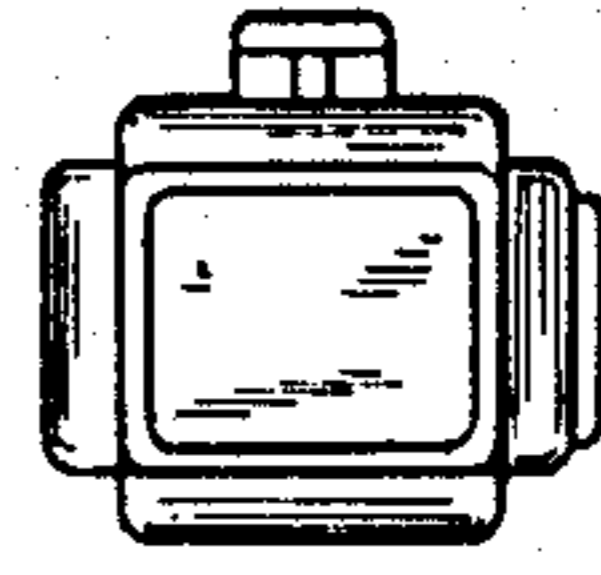

Fig. 15

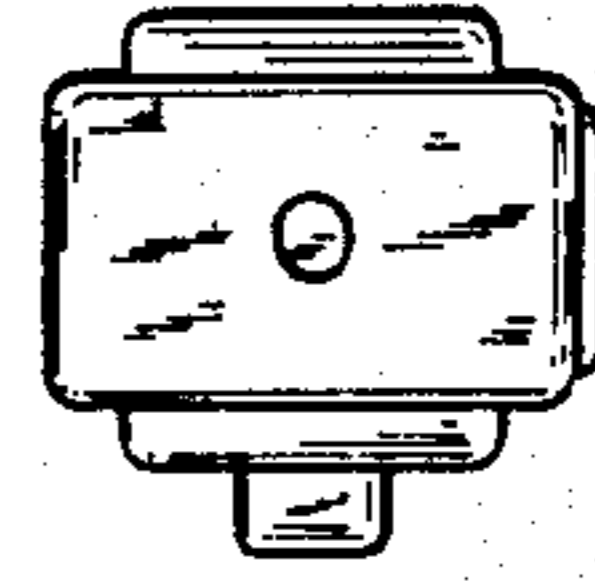

Fig. 10

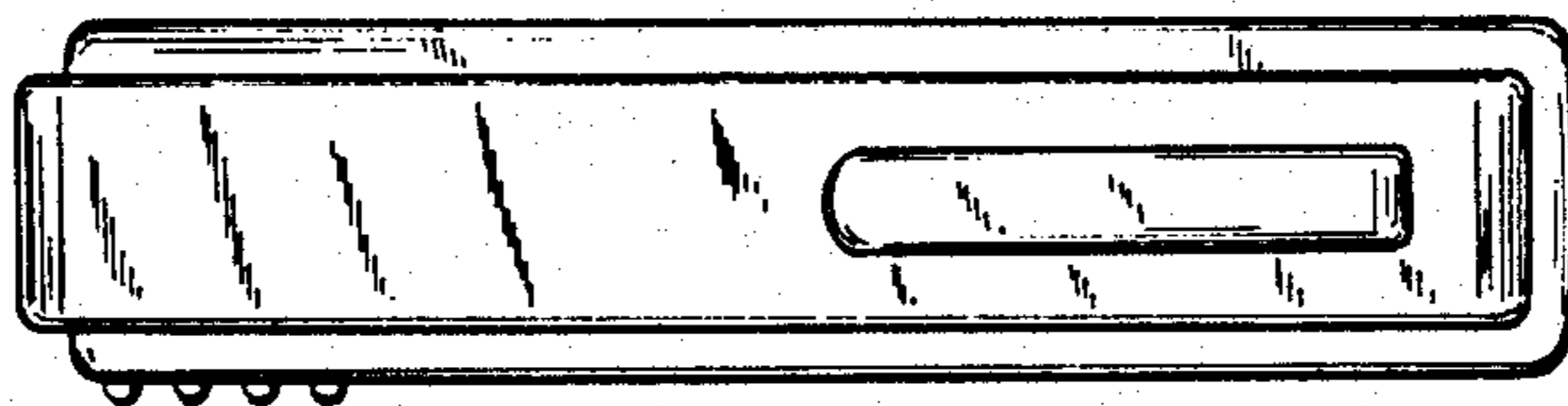

Fig. 11

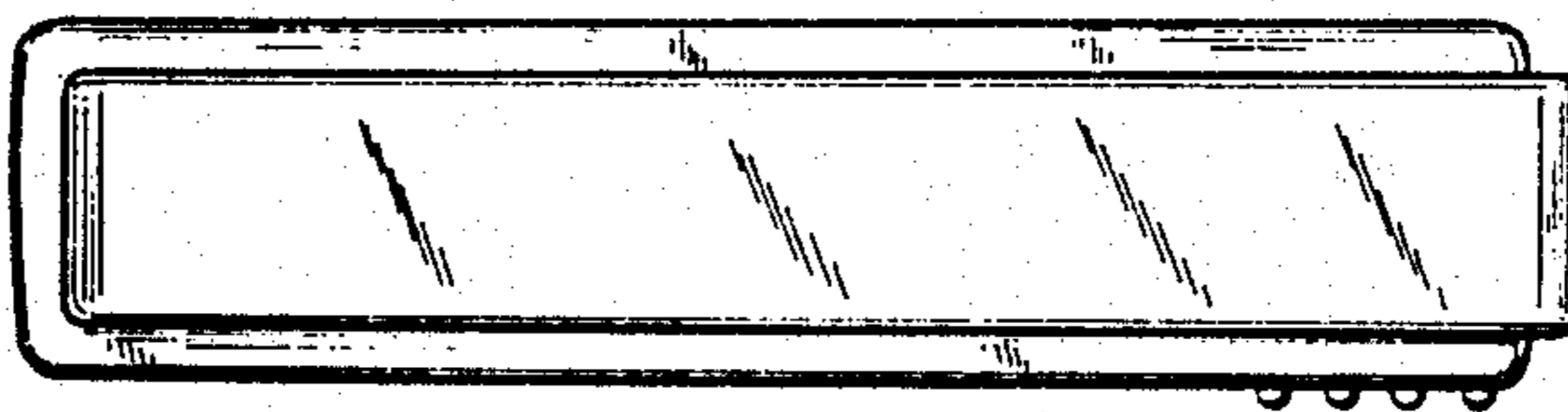

Fig. 12

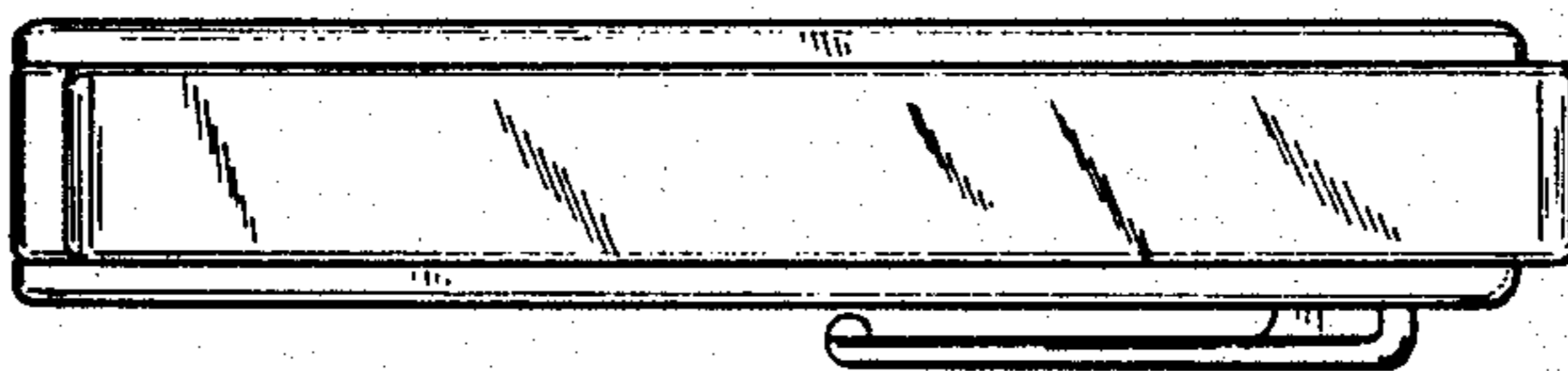

Fig. 13

