

[54] **BOTTLE**

[75] **Inventor: Bijan Pakzad, New York, N.Y.**

[73] **Assignee: Fashion World, Inc., Beverly Hills, Calif.**

[**] **Term: 14 Years**

[21] **Appl. No.: 838,047**

[22] **Filed: Feb. 27, 1986**

[52] **U.S. Cl. D9/382; D9/378; D9/403**

[58] **Field of Search D9/367, 370, 374, 378, D9/382, 384, 385, 392, 403, 406, 408, 337; 215/1 R, 1 C; D28/5, 91.1, 76**

[56] **References Cited**

U.S. PATENT DOCUMENTS

D. 86,703	4/1932	Delich	D9/337
D. 99,648	5/1936	Mulhens	D9/385
D. 105,379	7/1937	Guerlain	D9/384
D. 127,478	5/1941	Brown	D9/367
D. 175,090	7/1955	Newton	D9/337
D. 290,687	7/1987	Llorente	D9/385
11,149	4/1879	Hood	215/1 R
3,171,559	3/1965	Ferree	215/1 C

FOREIGN PATENT DOCUMENTS

652426	4/1928	France	215/1 R
356369	10/1938	Italy	215/1 R

OTHER PUBLICATIONS

Beauty Fashion Magazine, Feb. 1981, p. 2, Galanos Bottle.
 Beauty Fashion Magazine, Aug. 1984, p. 50, Hermes Bottle, upper right.
 Beauty Fashion Magazine, Oct. 1984, p. 101, Balà Versailles Bottle.
 Beauty Fashion Magazine, Jul. 1985, p. 54, Anne Klein Bottle, lower left.

Primary Examiner—Melvin B. Feifer
Assistant Examiner—Lucy Lieberman
Attorney, Agent, or Firm—Sughrue, Mion, Zinn, Macpeak and Seas

[57] **CLAIM**

The ornamental design for a bottle, as shown.

DESCRIPTION

FIG. 1 is a front view of a bottle showing my new design;
 FIG. 2 is a side view thereof;
 FIG. 3 is a top view;
 FIG. 4 is a bottom view; and
 FIG. 5 is a perspective view.

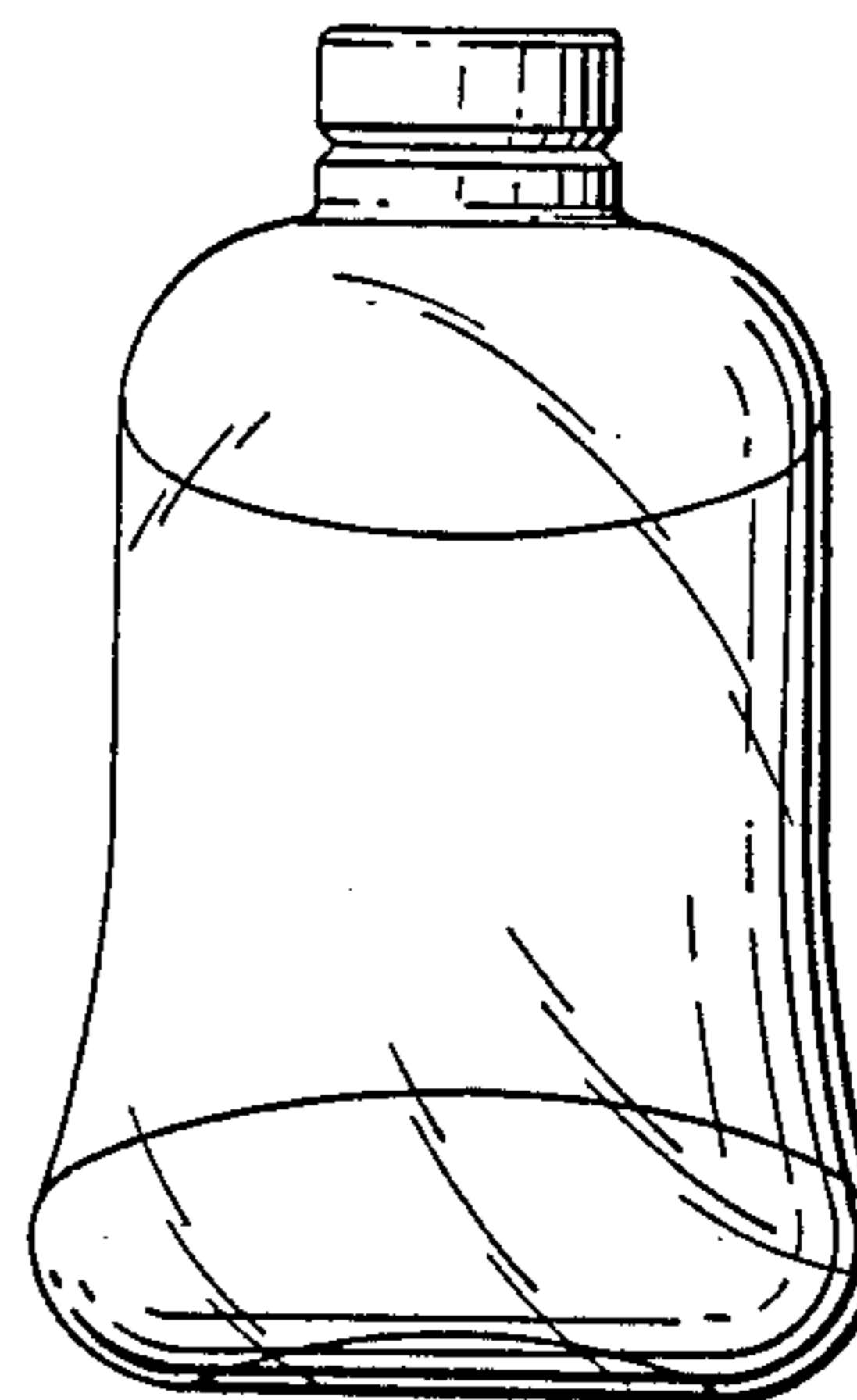
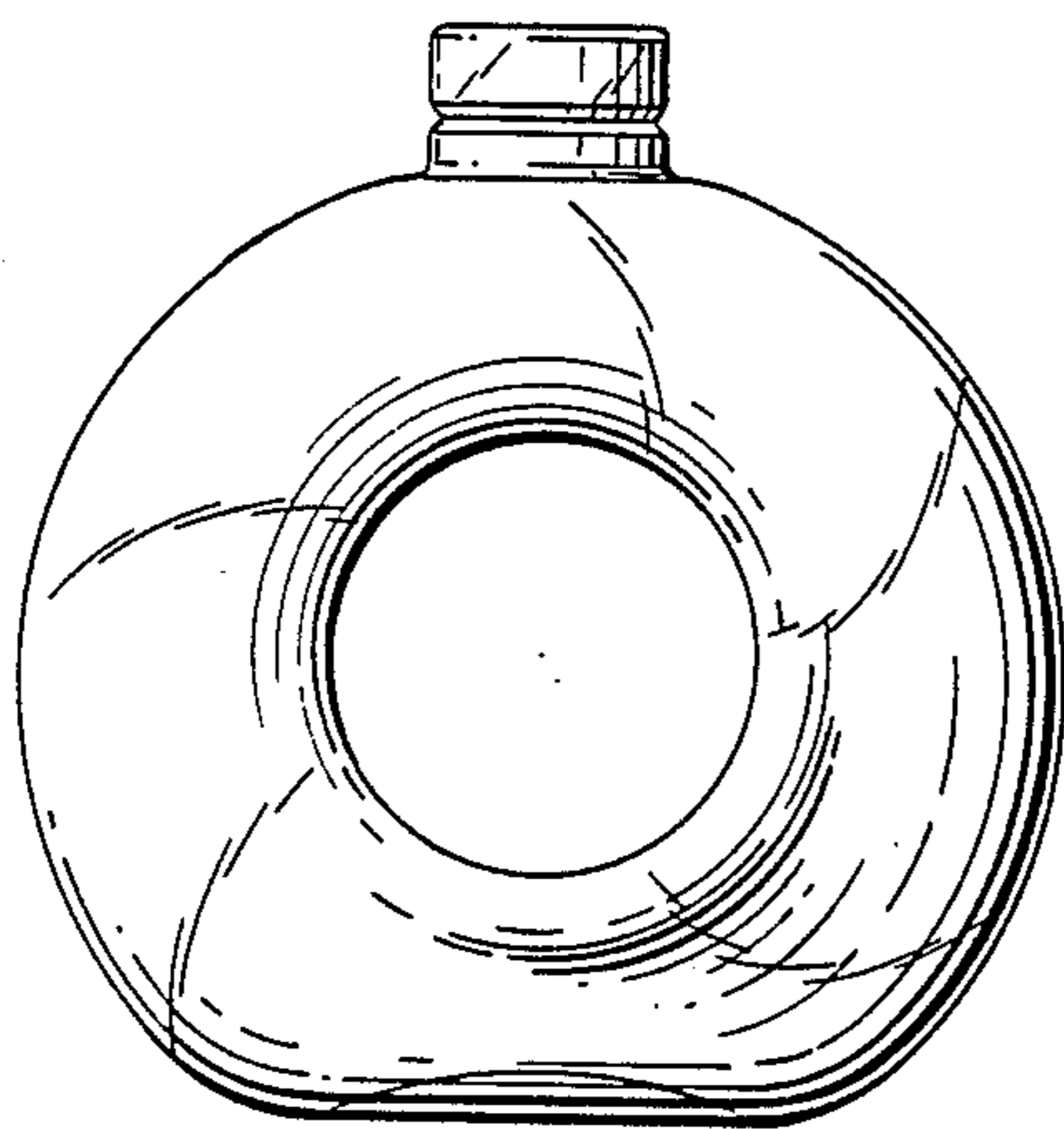

FIG. 1

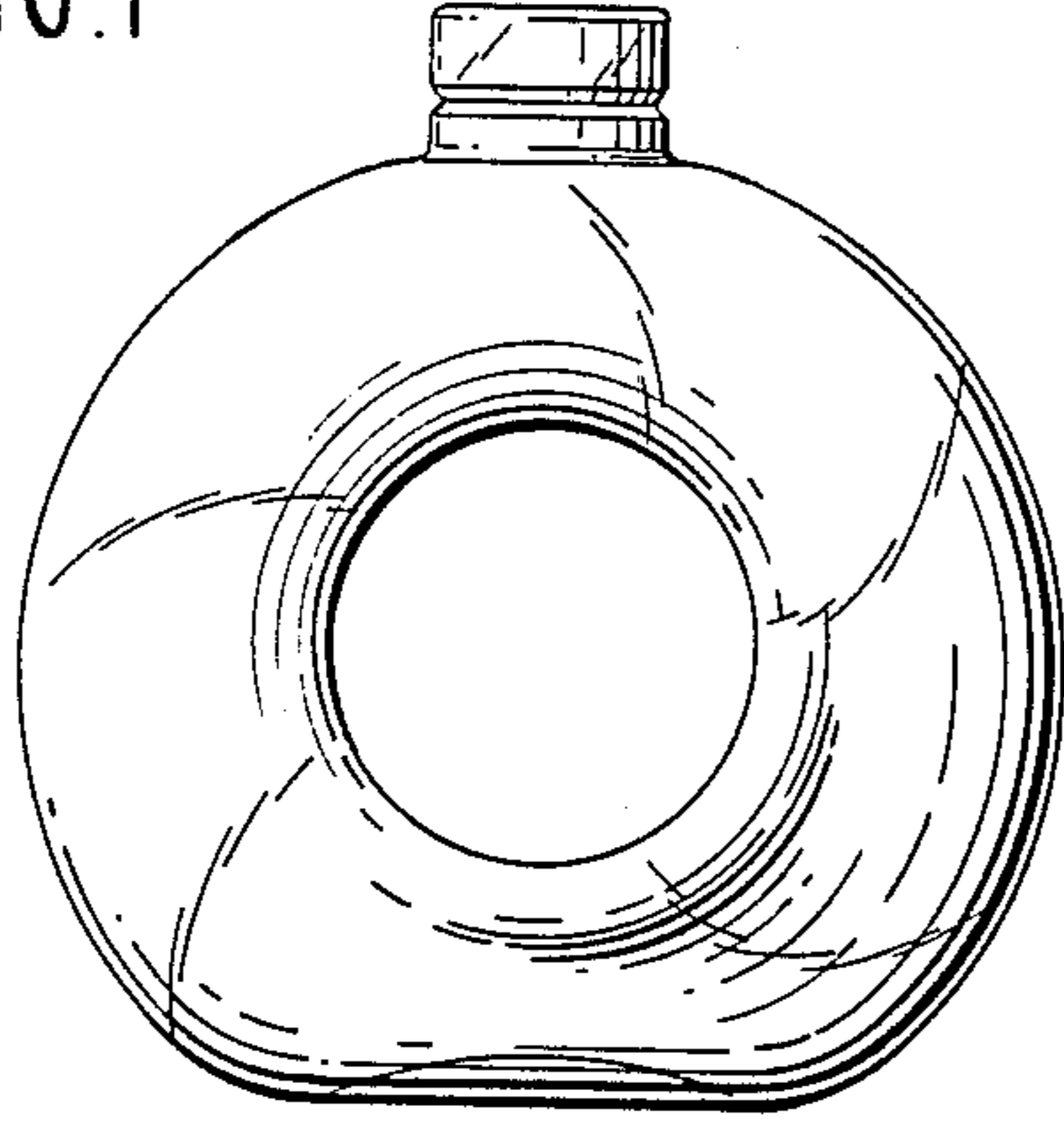

FIG. 2

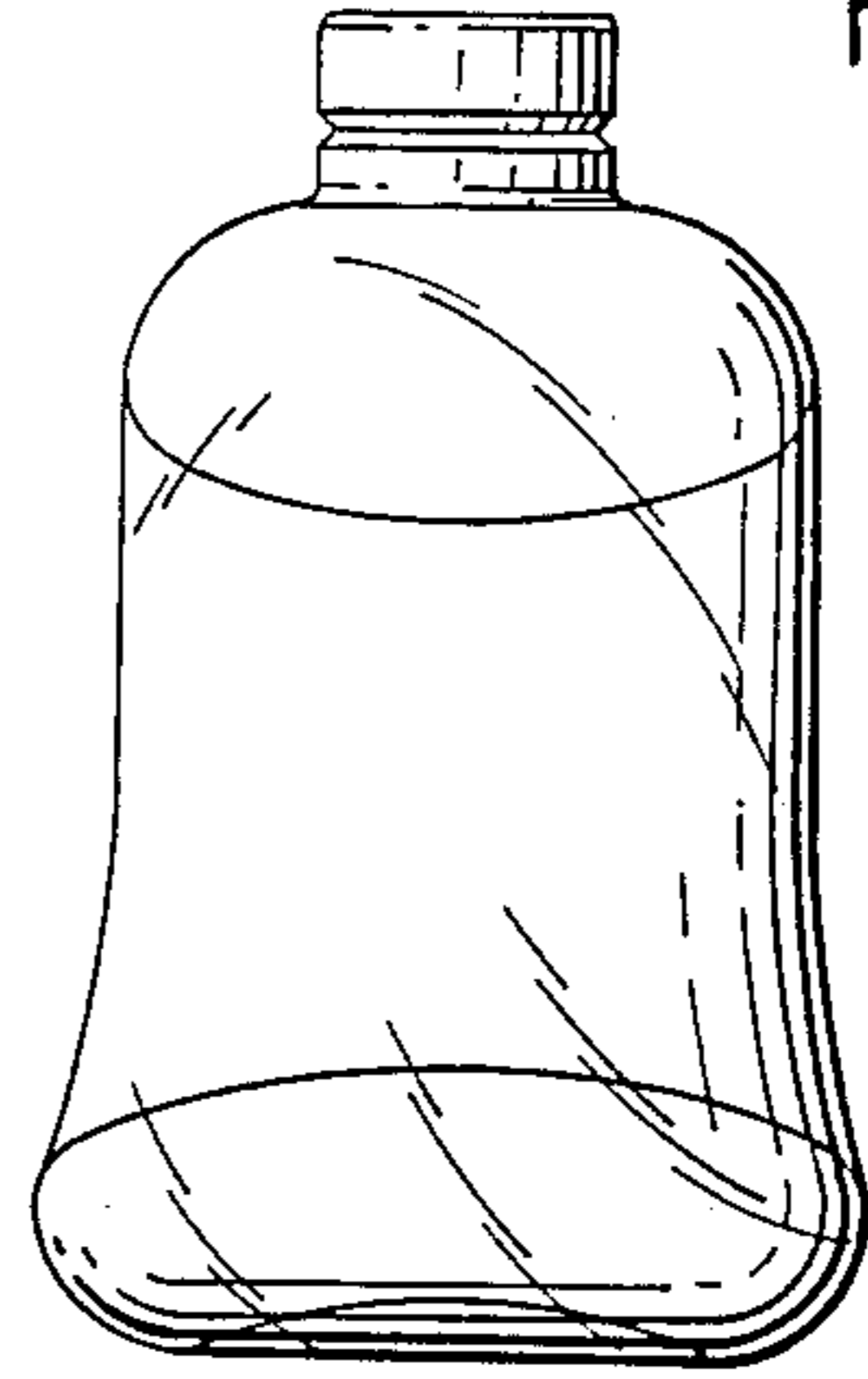

FIG. 3

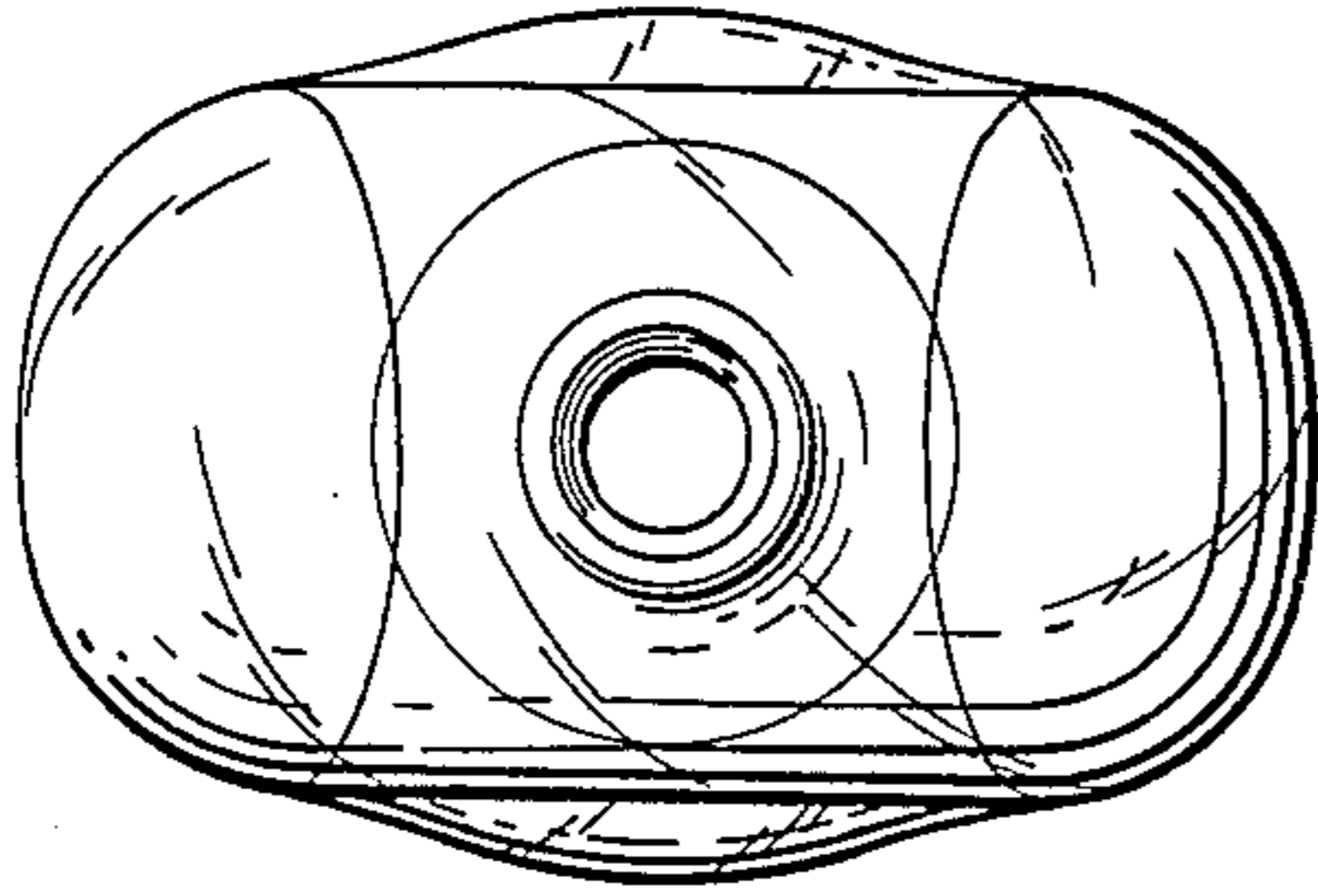

FIG. 4

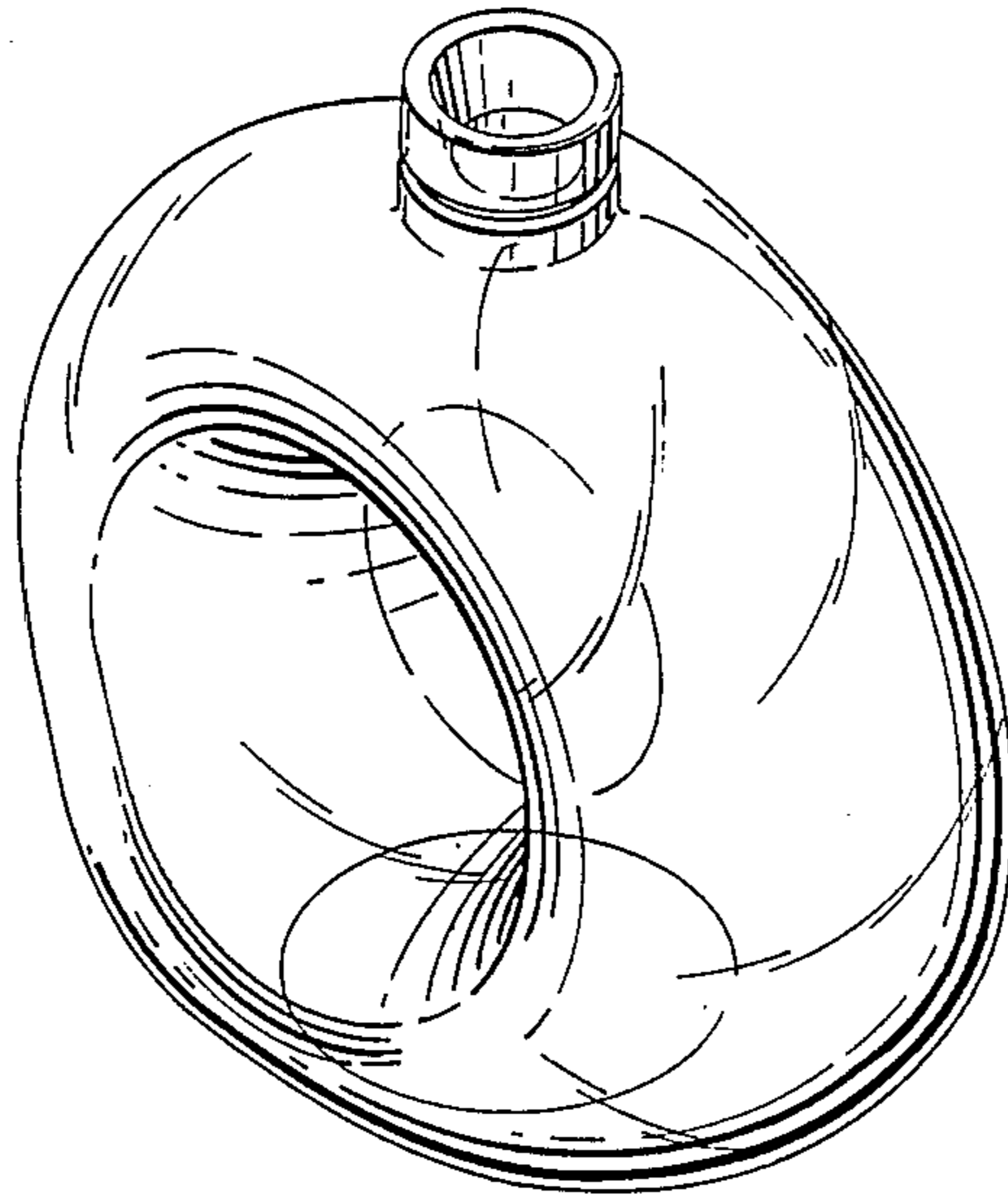
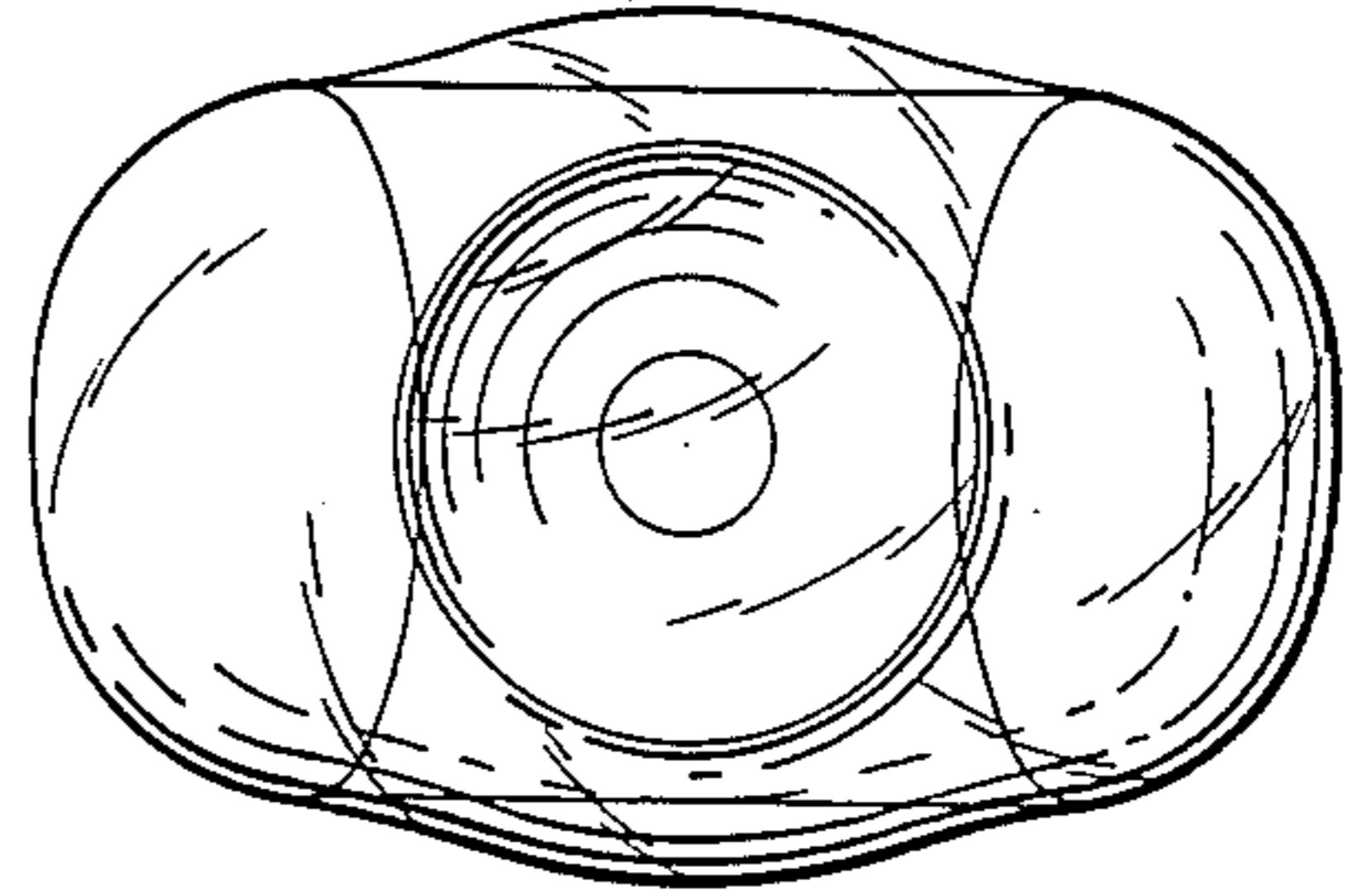

FIG. 5