

[54] **CONSTRUCTION BLOCK**

[75] **Inventor: Pieter D. Swart, Verwoerdburg, South Africa**

[73] **Assignee: Sylsands Securities (Proprietary) Ltd., Pretoria West, South Africa**

[\*\*] **Term: 14 Years**

[21] **Appl. No.: 901,934**

[22] **Filed: Aug. 28, 1986**

[30] **Foreign Application Priority Data**

Mar. 4, 1986 [ZA] South Africa ..... 86/0176  
[52] **U.S. Cl. .... D25/113**  
[58] **Field of Search .... D25/113-118;**  
52/605, 608, 596, 606, 610, 609, 611

[56] **References Cited**

**U.S. PATENT DOCUMENTS**

1,894,605 1/1933 Wright ..... D25/113 X  
4,083,190 4/1978 Pey ..... 52/608 X

*Primary Examiner—A. Hugo Word*  
*Attorney, Agent, or Firm—Ladas & Parry*

[57] **CLAIM**

The ornamental design for a construction block, as shown and described.

**DESCRIPTION**

FIG. 1 is a perspective view of a construction block showing my new design;  
FIG. 2 is a top plan view thereof;  
FIG. 3 is a bottom plan view thereof;  
FIG. 4 is a front elevational view thereof;  
FIG. 5 is a rear elevational view thereof;  
FIG. 6 is an end elevational view thereof; and,  
FIG. 7 is an opposite end elevational view thereof.

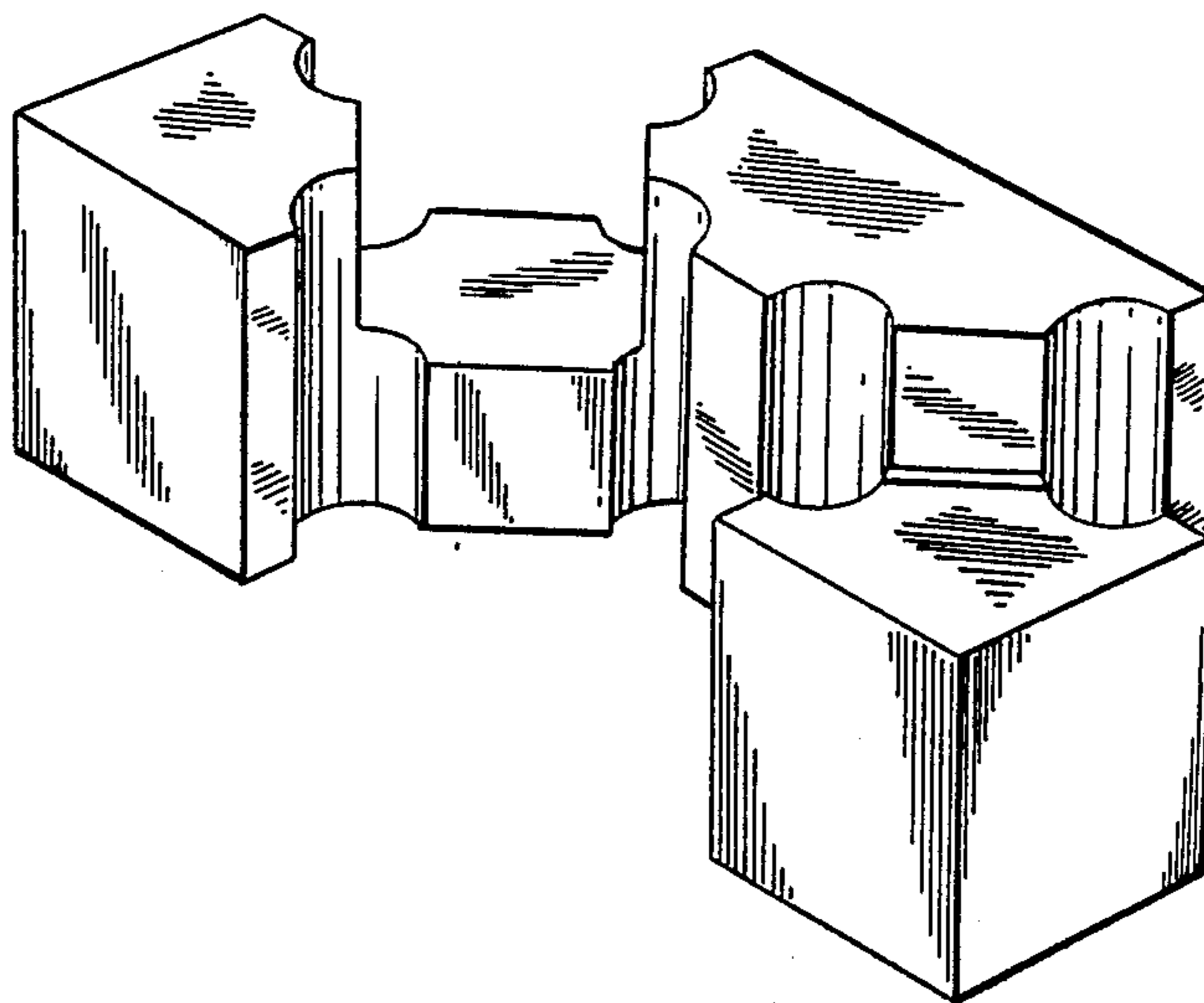

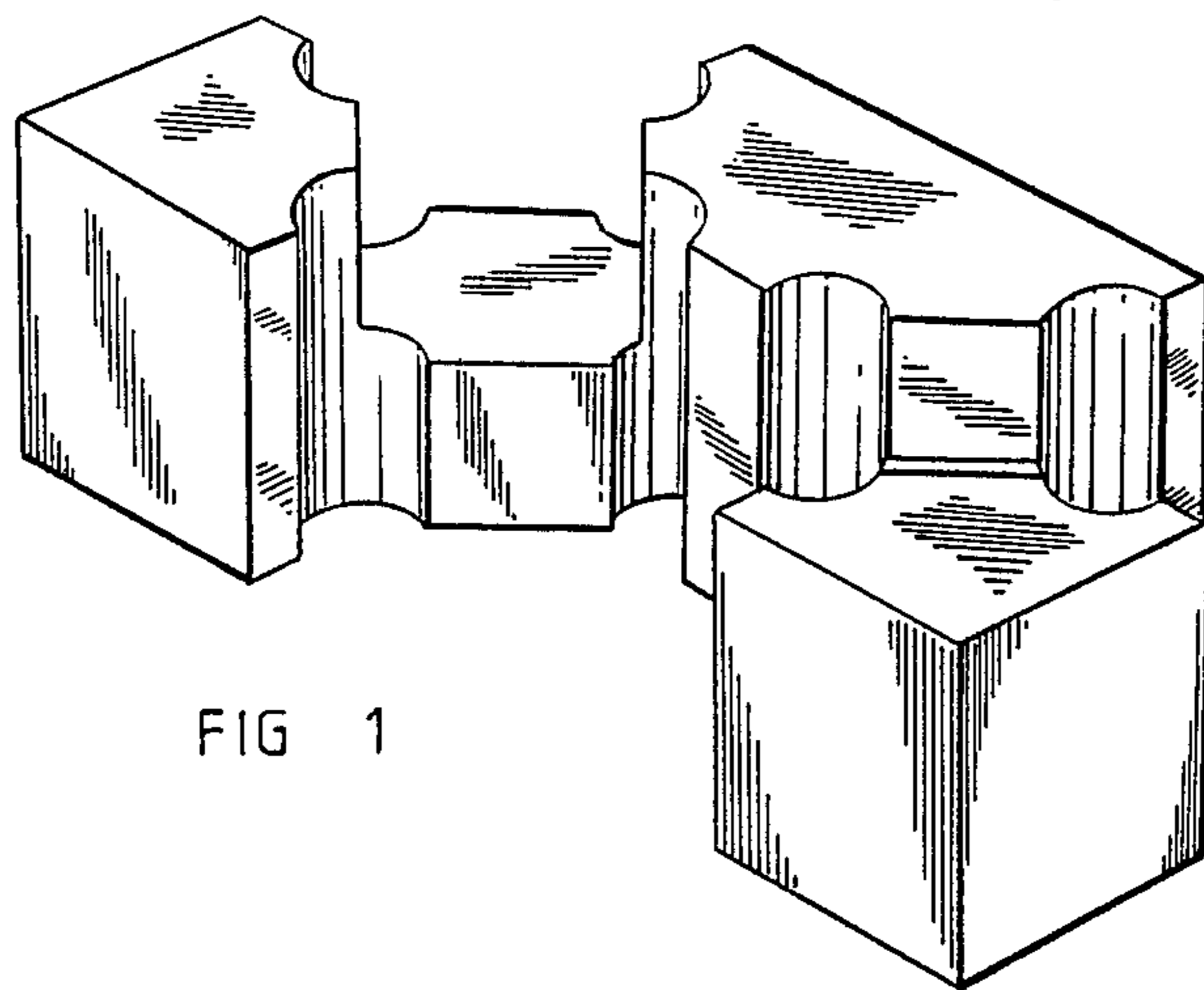

FIG 1

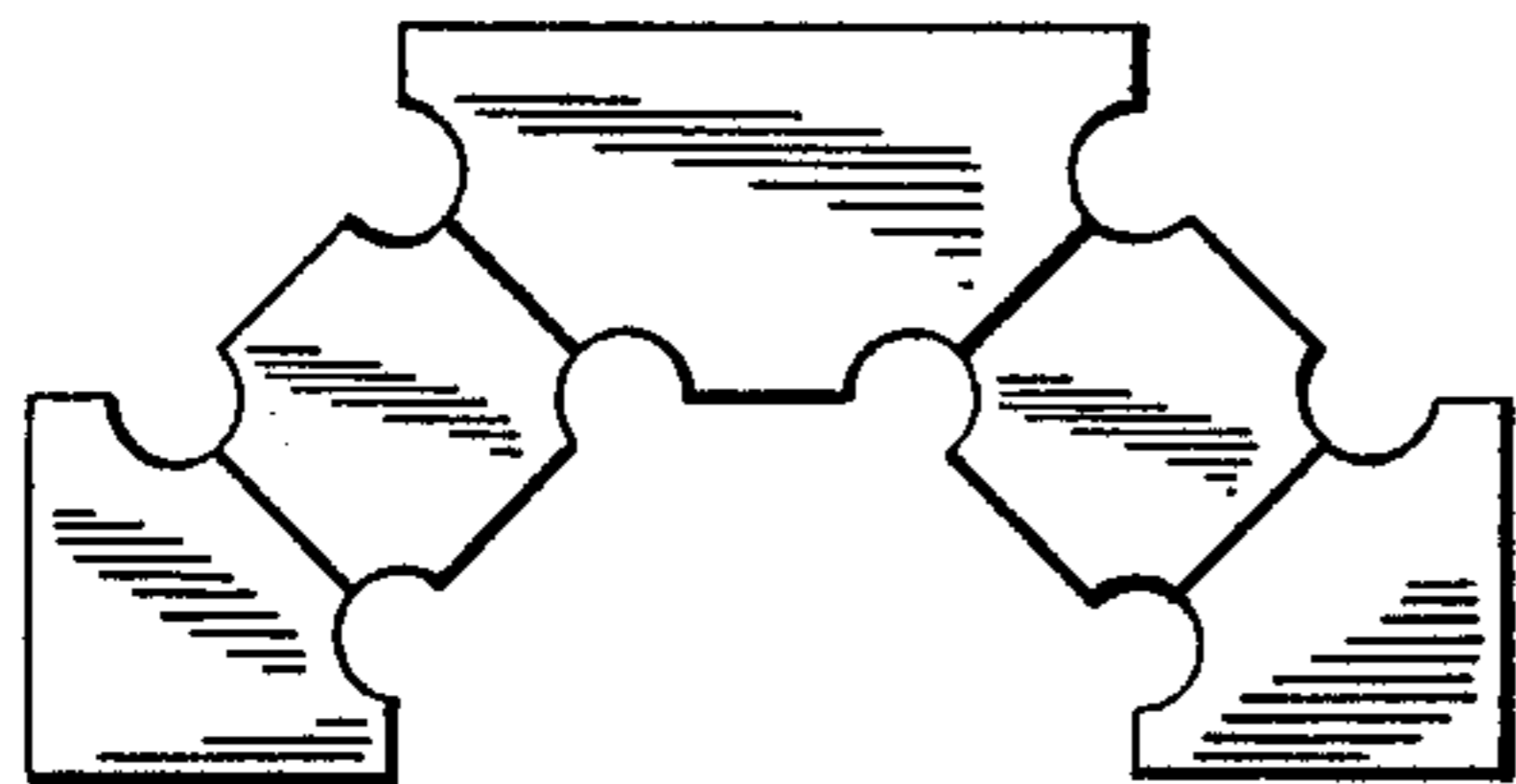

FIG 2

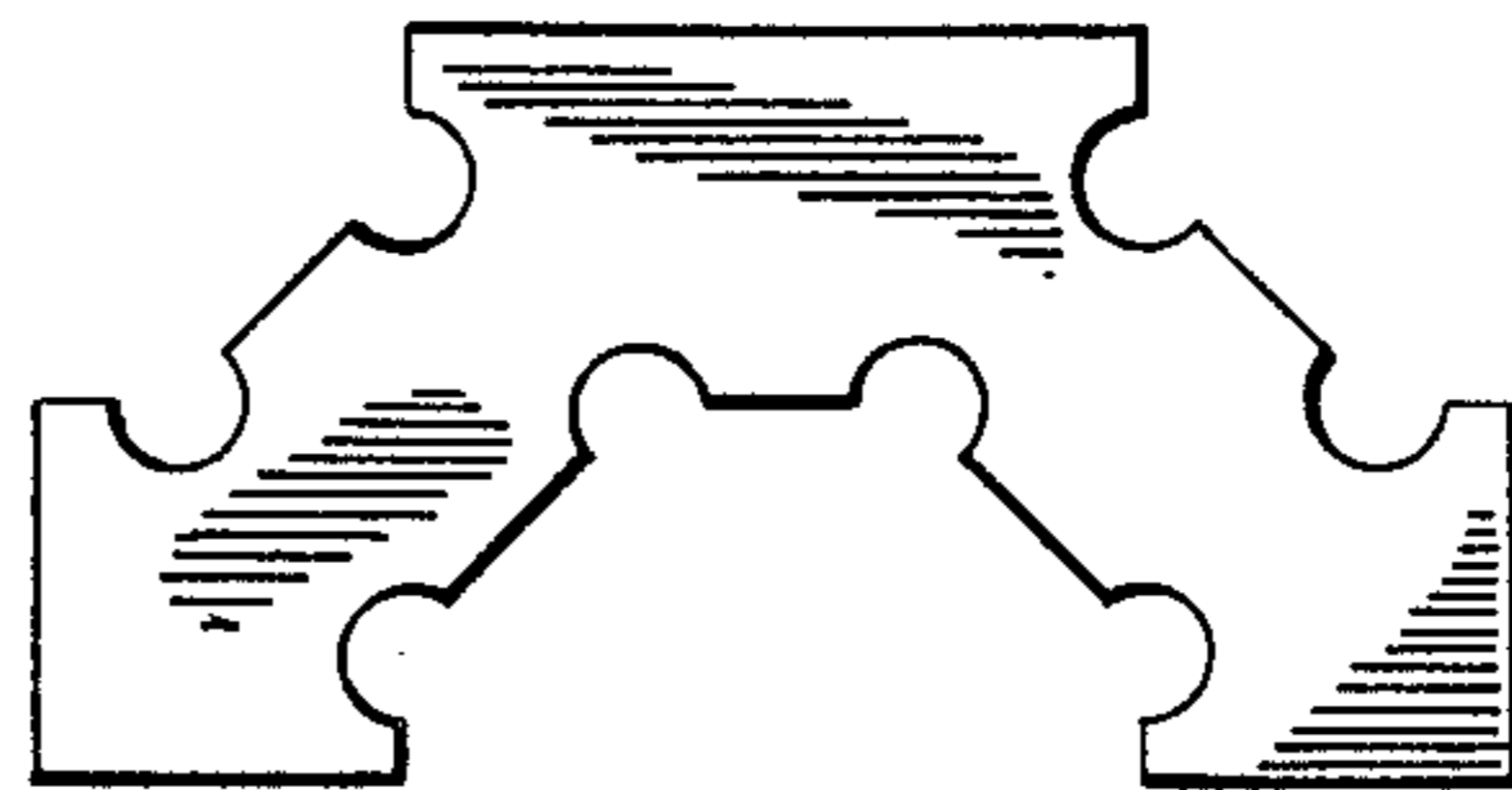

FIG 3

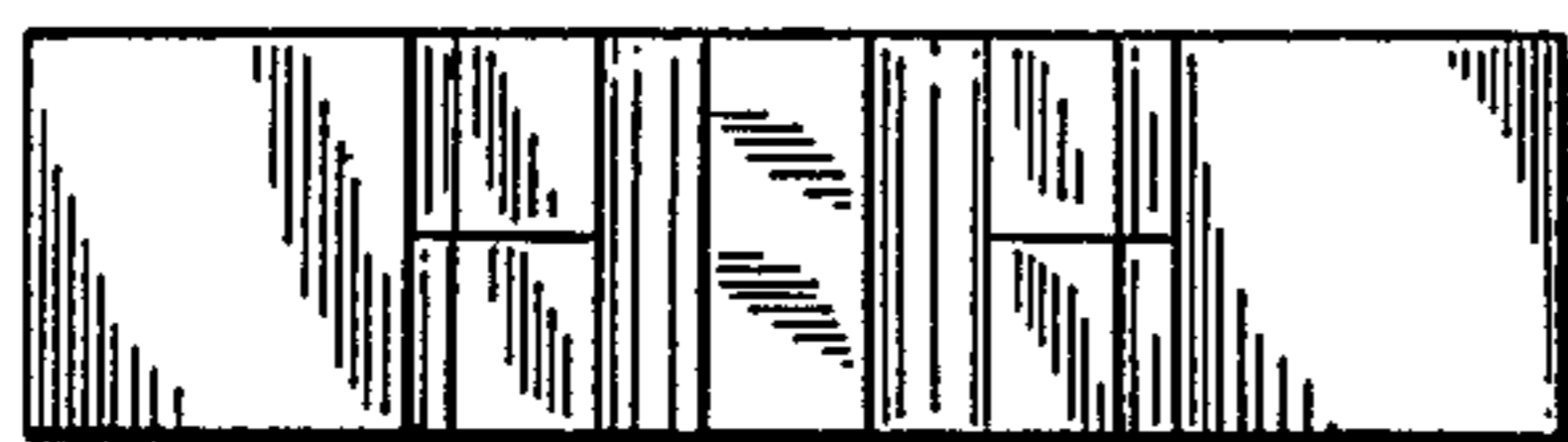

FIG 4

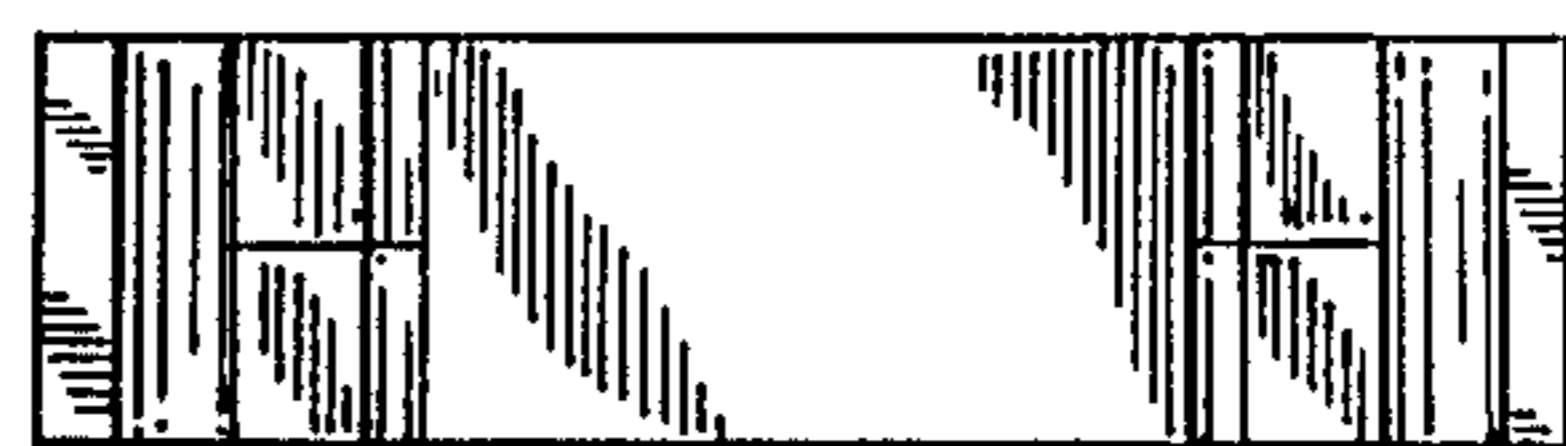

FIG 5



FIG 6

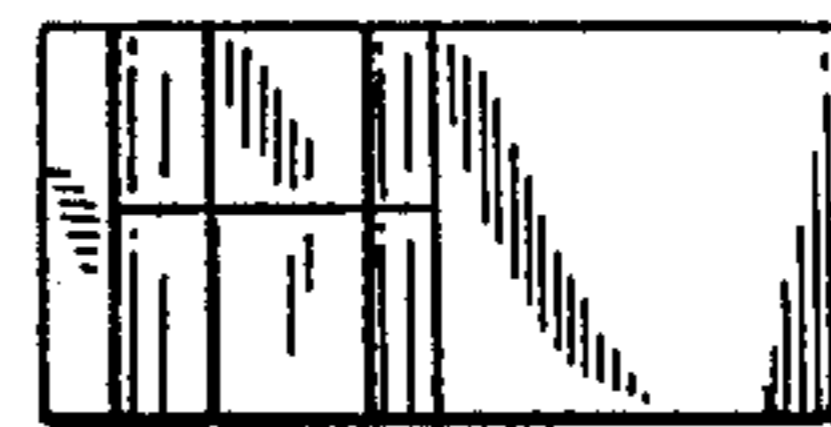

FIG 7