

[54] CARD FILE

[75] Inventors: Kenneth C. Foran, Wooster; Thomas J. David, Worthington, both of Ohio

[73] Assignee: Rubbermaid Incorporated, Wooster, Ohio

[**] Term: 14 Years

[21] Appl. No.: 894,180

[22] Filed: Aug. 7, 1986

[52] U.S. Cl. D19/75; D19/86

[58] Field of Search D3/30.1, 35, 78; D19/65, 75, 76, 86; 211/11; 206/444, 449, 387, 425, 555; 312/183, 184

[56] References Cited

U.S. PATENT DOCUMENTS

D. 258,295	2/1981	Evenson	D19/76
D. 266,526	10/1982	Raine	D19/76
D. 267,911	2/1983	Long et al.	D3/35
4,540,090	9/1985	Gelardi et al.	206/387
4,544,213	10/1985	Long et al.	312/183

OTHER PUBLICATIONS

Catalog p. 10, Lion Office Products, Inc., 401 W. Alondra Blvd. Gardena, CA 90248, Publ.-1986.

Catalog Page, Eldon Office Products Inc., 1130 East 230th St., Carson, CA 90745, Publ. Date-1986.

Catalog p. 7, W. T. Rogers Company, 1401 W. Badger Road, P.O. Box 4327, Date-1985.

Primary Examiner—Bruce W. Dunkins

Assistant Examiner—Martha Thompson

Attorney, Agent, or Firm—Richard B. O'Planick

[57] CLAIM

The ornamental design for a card file, as shown.

DESCRIPTION

FIG. 1 is a front perspective view of a card file showing our new design;

FIG. 2 is a top plan view;

FIG. 3 is a front elevational view;

FIG. 4 is a side elevational view;

FIG. 5 is a rear elevational view; and

FIG. 6 is a bottom plan view thereof.

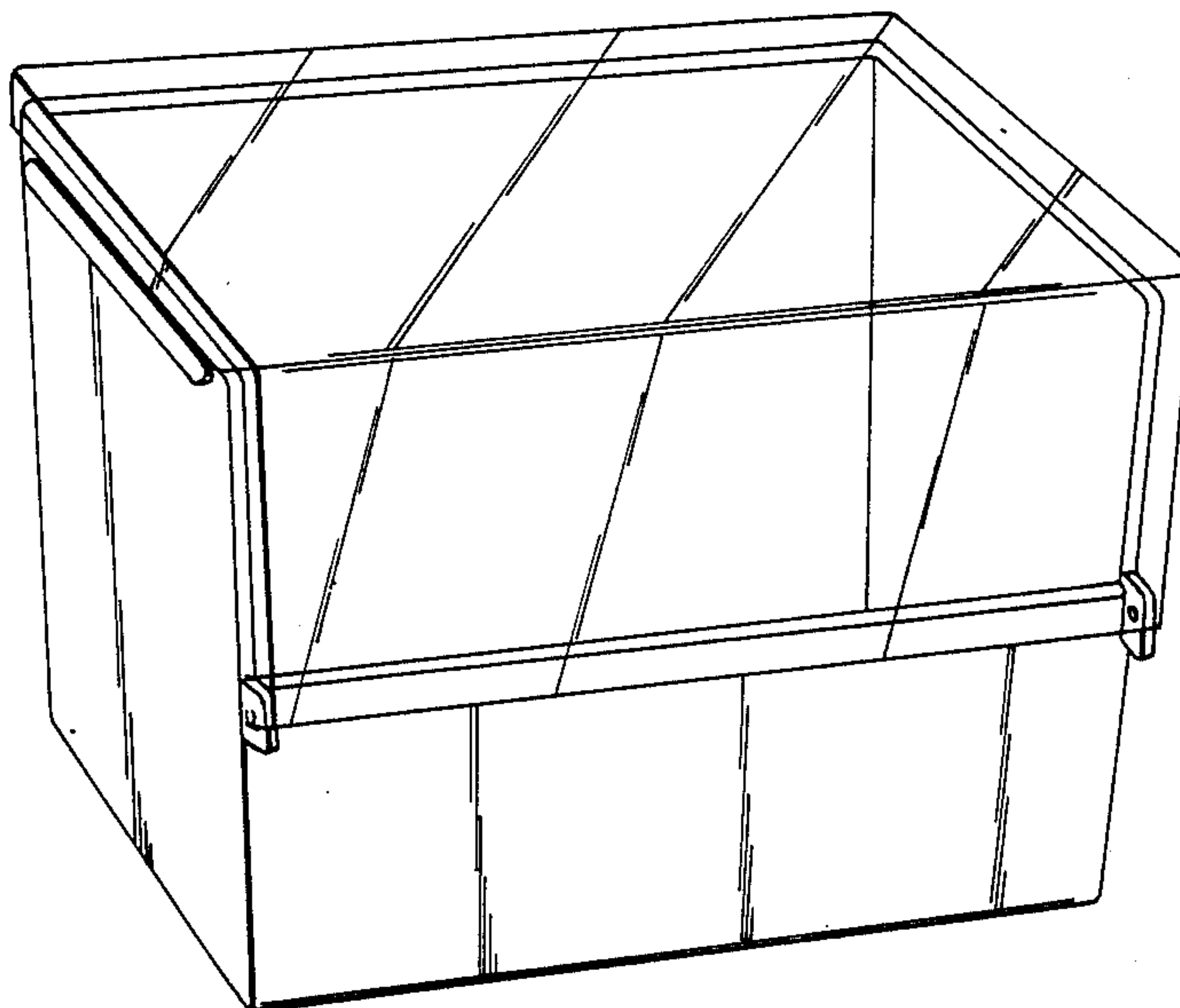

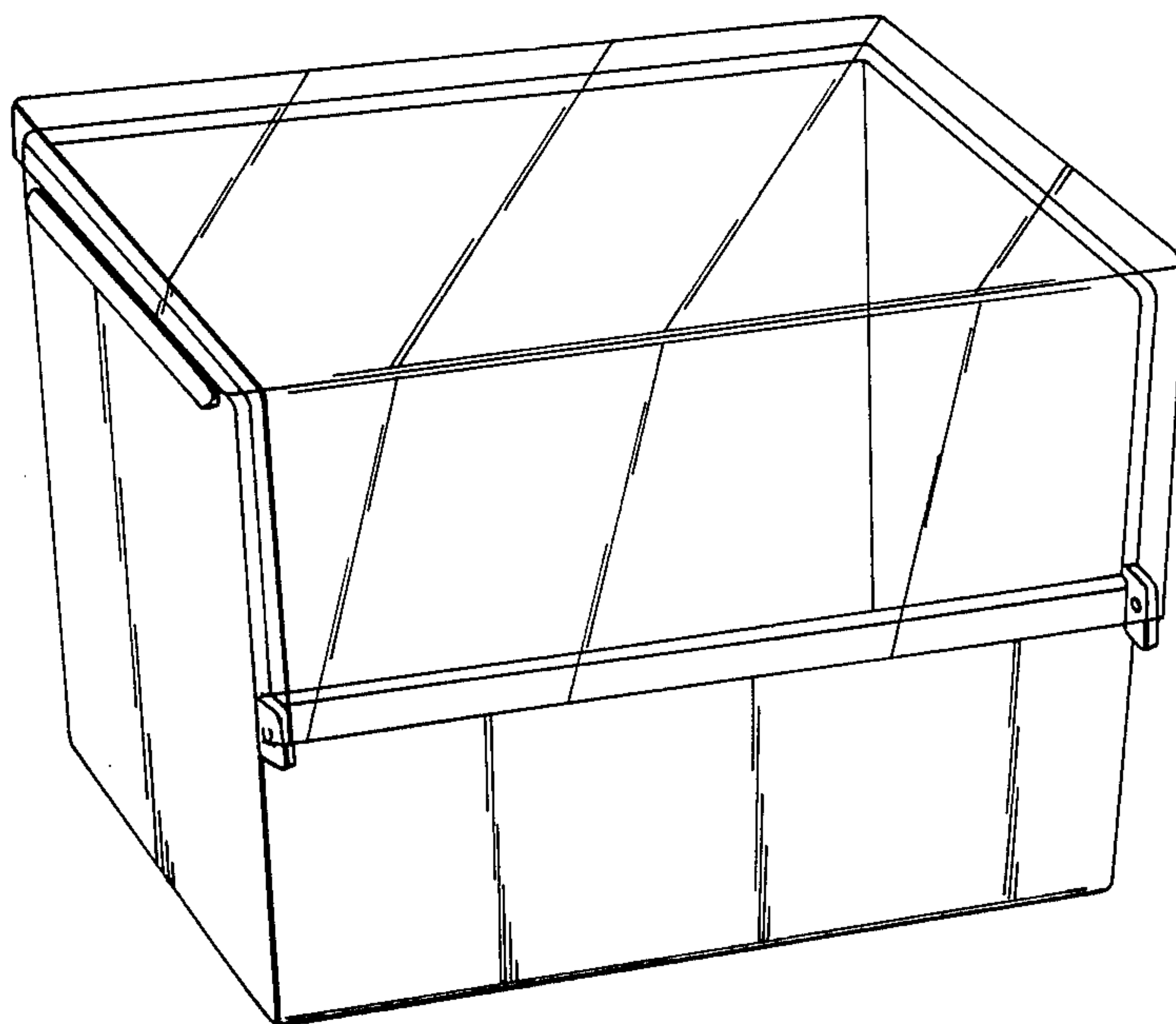

Fig. 1

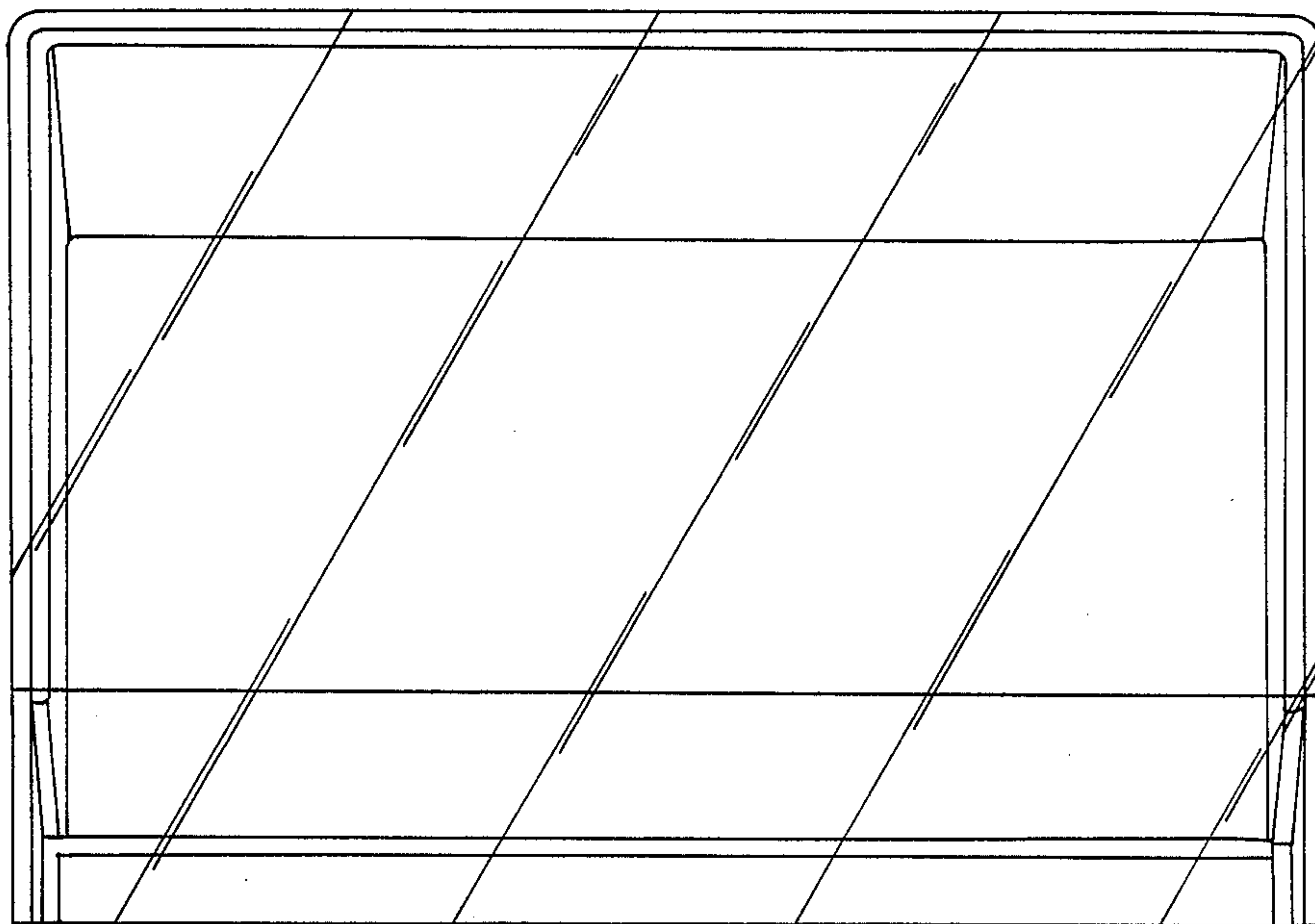

Fig. 2

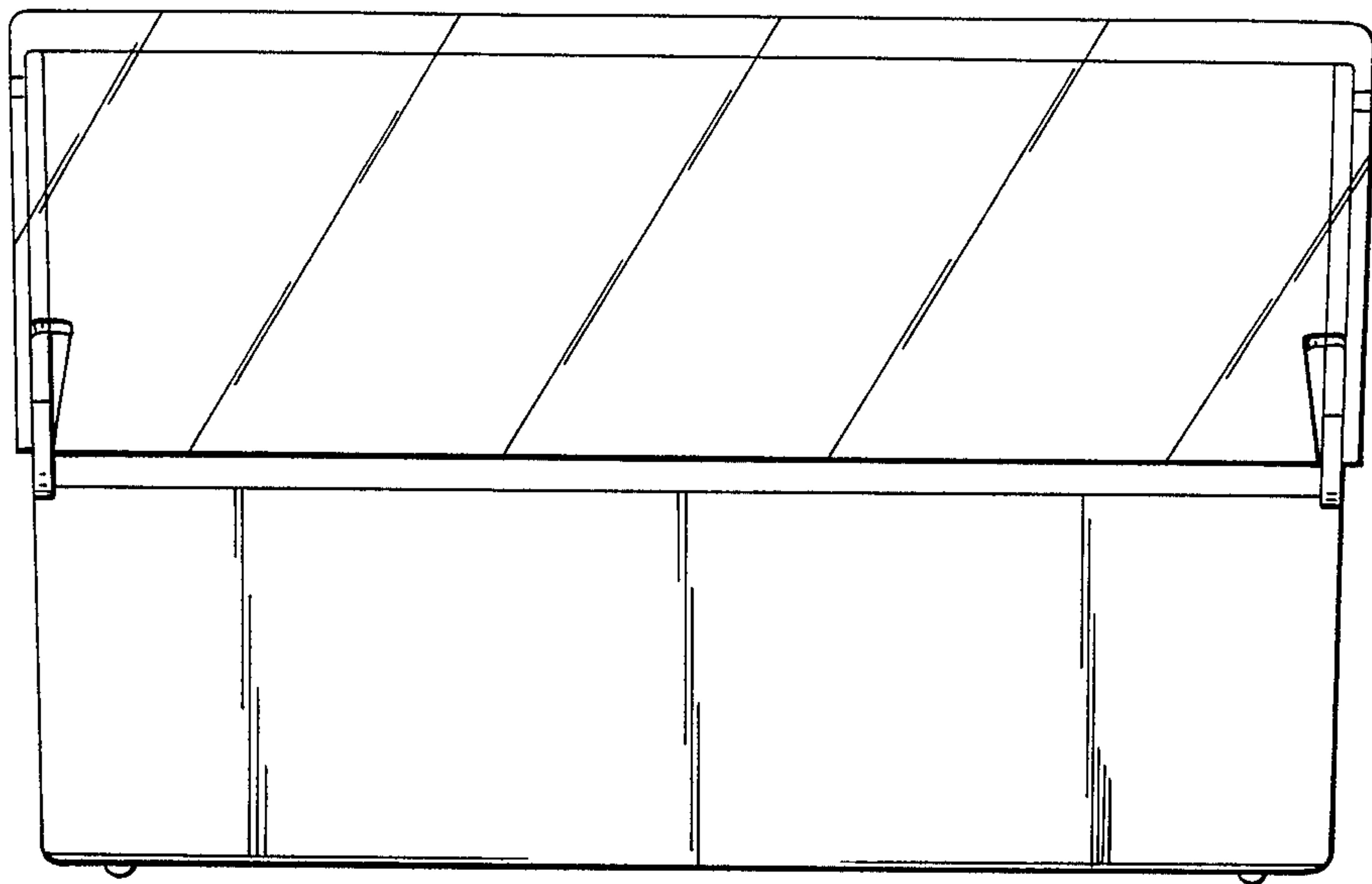

Fig. 3

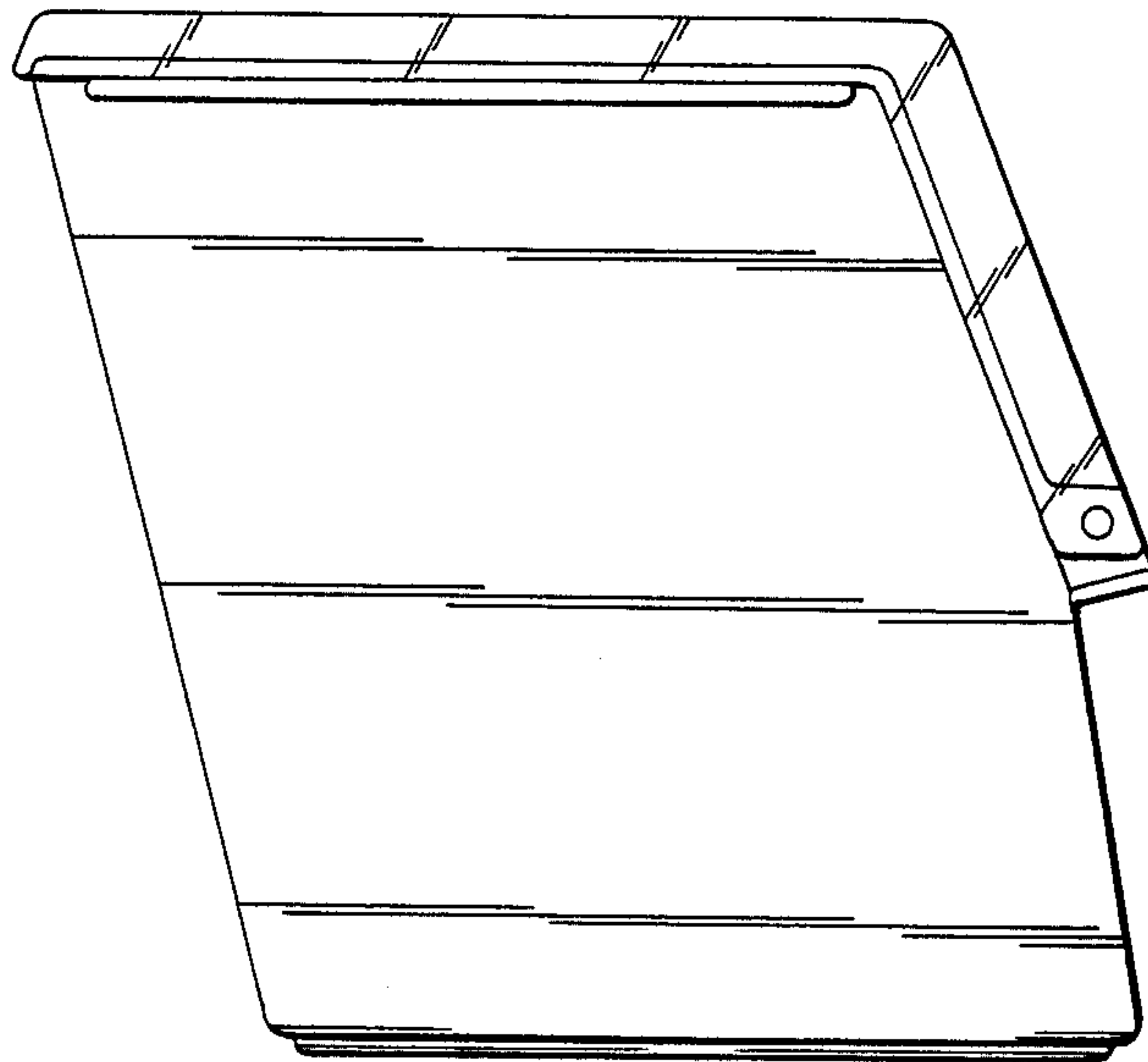

Fig. 4

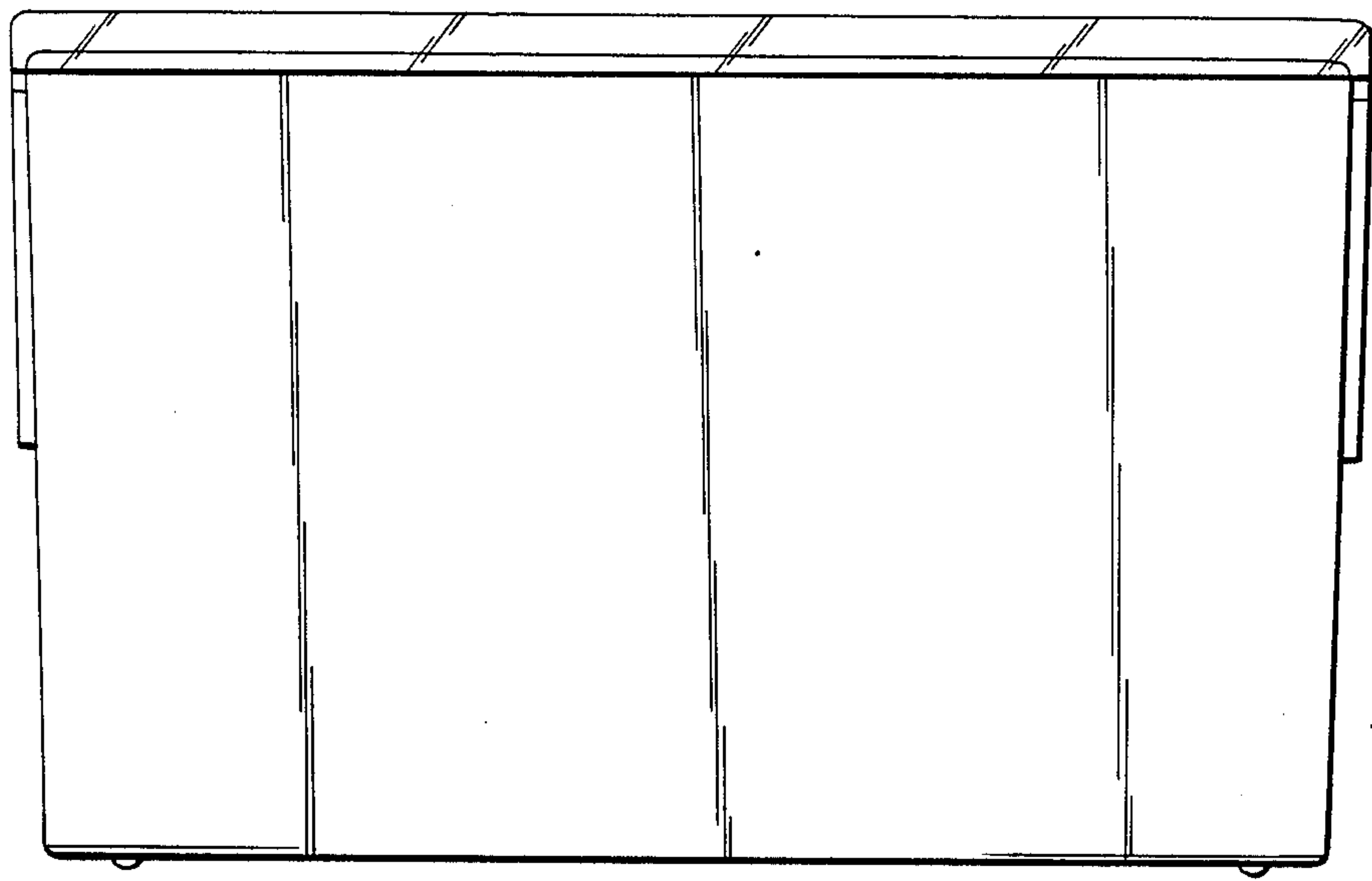

Fig. 5

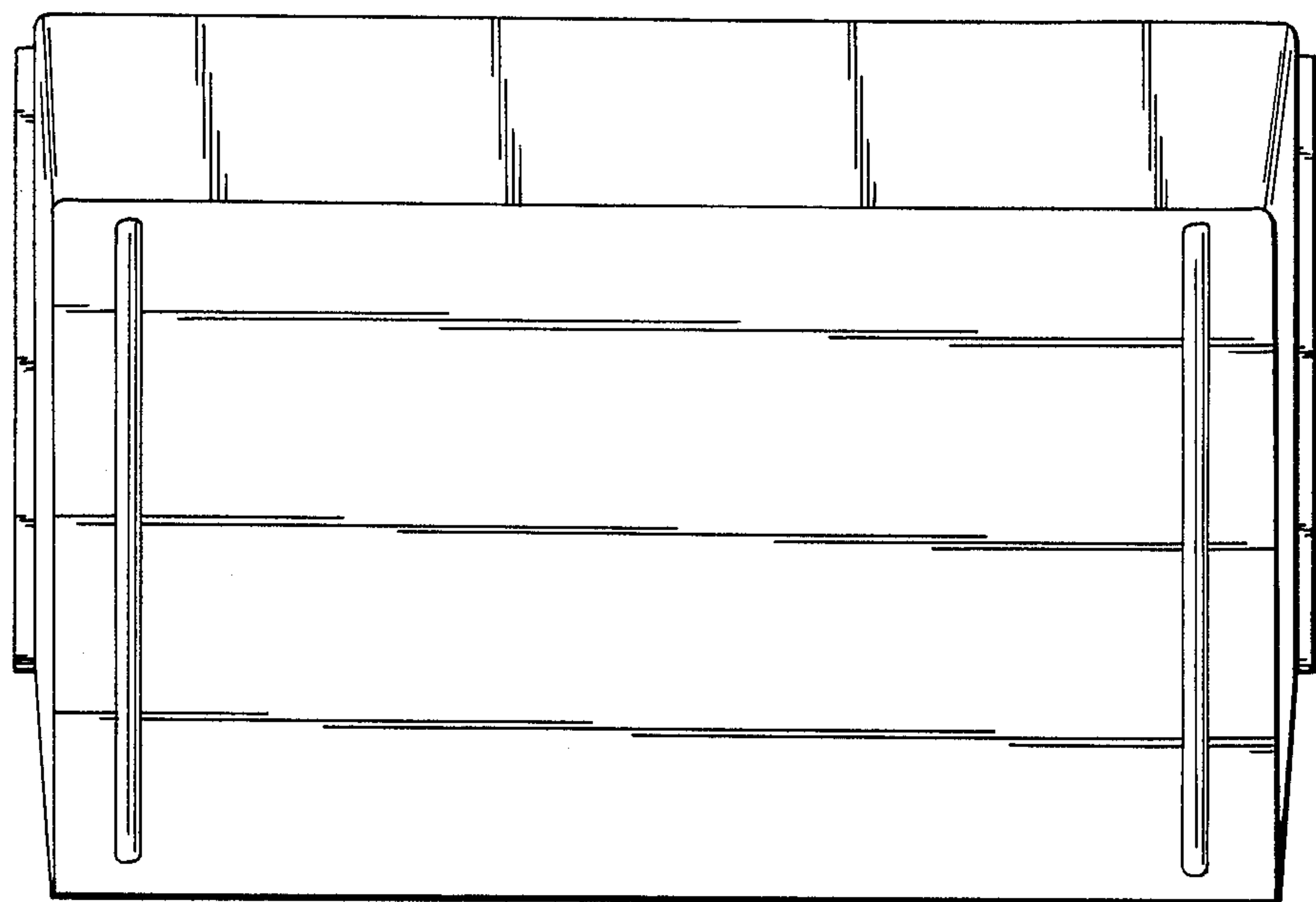

Fig. 6