

United States Patent [19]

Kloberg, Jr.

[11] Patent Number: Des. 301,102

[45] Date of Patent: ** May 16, 1989

[54] DISPOSABLE BAG HOLDER

[76] Inventor: John Kloberg, Jr., P.O. Box 4742,
Montgomery, Ala. 36103

[**] Term: 14 Years

[21] Appl. No.: 140,414

[22] Filed: Jan. 4, 1988

[52] U.S. Cl. D6/567

[58] Field of Search D6/512, 515, 553, 572,
D6/518; 211/181-182, 13, 71, 106; 248/95, 97,
99-100, 127, 146, 153, 175; 312/211

[56] References Cited

U.S. PATENT DOCUMENTS

D. 297,795	9/1988	Bateman	D6/566
D. 299,177	12/1988	Bryan	D6/566 X
1,018,817	2/1912	Farrell	D6/518 X
4,199,122	4/1980	Christie	248/97
4,498,652	2/1985	Malik	248/99

Primary Examiner—Wallace R. Burke

Assistant Examiner—Brian N. Vinson
Attorney, Agent, or Firm—Jennings, Carter, Thompson
& Veal

[57] CLAIM

The ornamental design for a disposable bag holder, as shown and described.

DESCRIPTION

FIG. 1 is a perspective view of a disposable bag holder showing my new design;
FIG. 2 is a front elevational view thereof;
FIG. 3 is a rear elevational view thereof;
FIG. 4 is a left side elevational view thereof, the right side being a mirror image of that shown;
FIG. 5 is a vertical cross-sectional view thereof, taken along line 5—5 of FIG. 2;
FIG. 6 is a top plan view thereof;
FIG. 7 is a bottom view thereof; and
FIG. 8 is a reduced perspective view thereof, the broken-line showing of the disposable bag being shown for illustrative purposes only and forming no part of the claimed design.

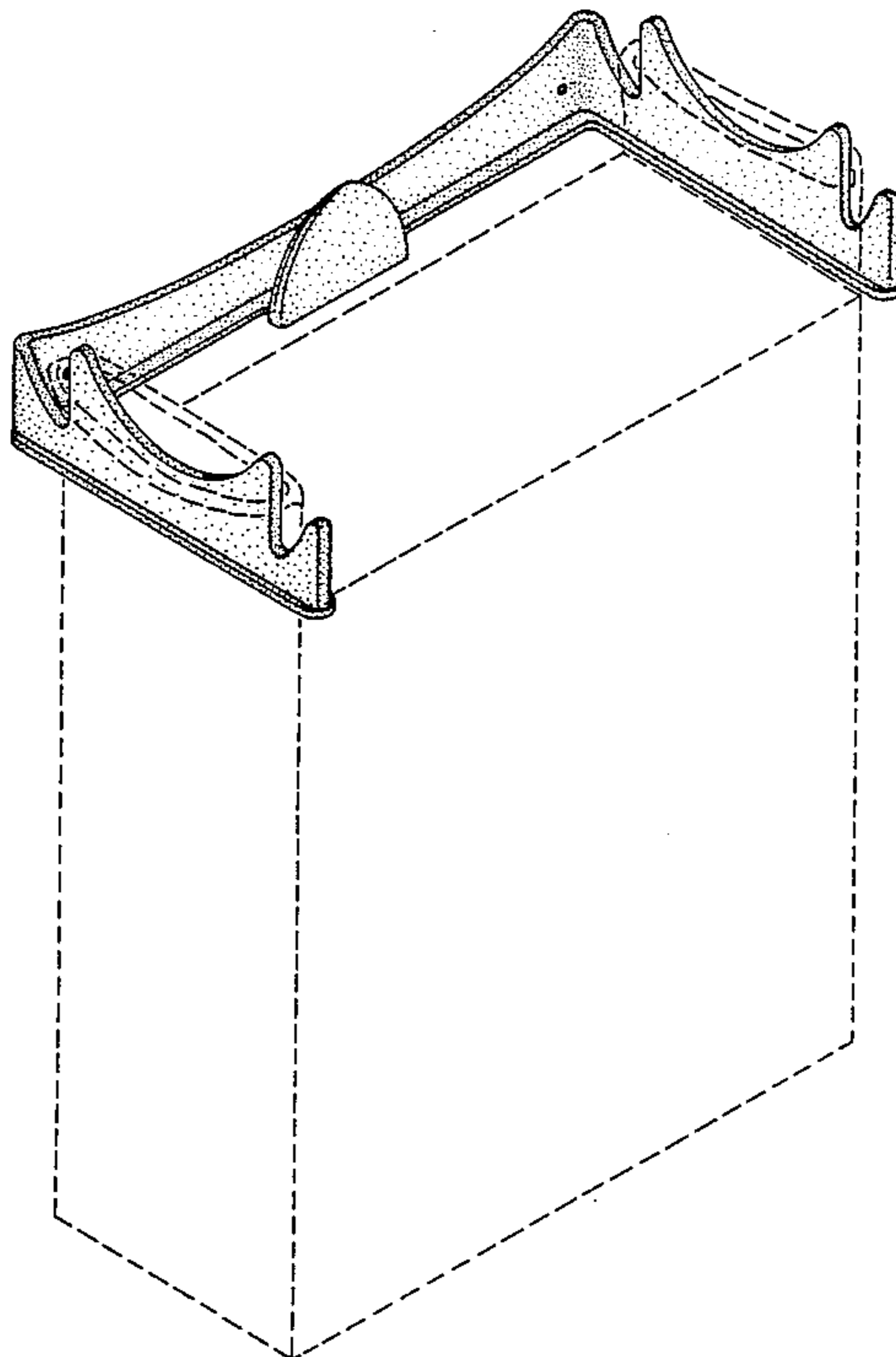

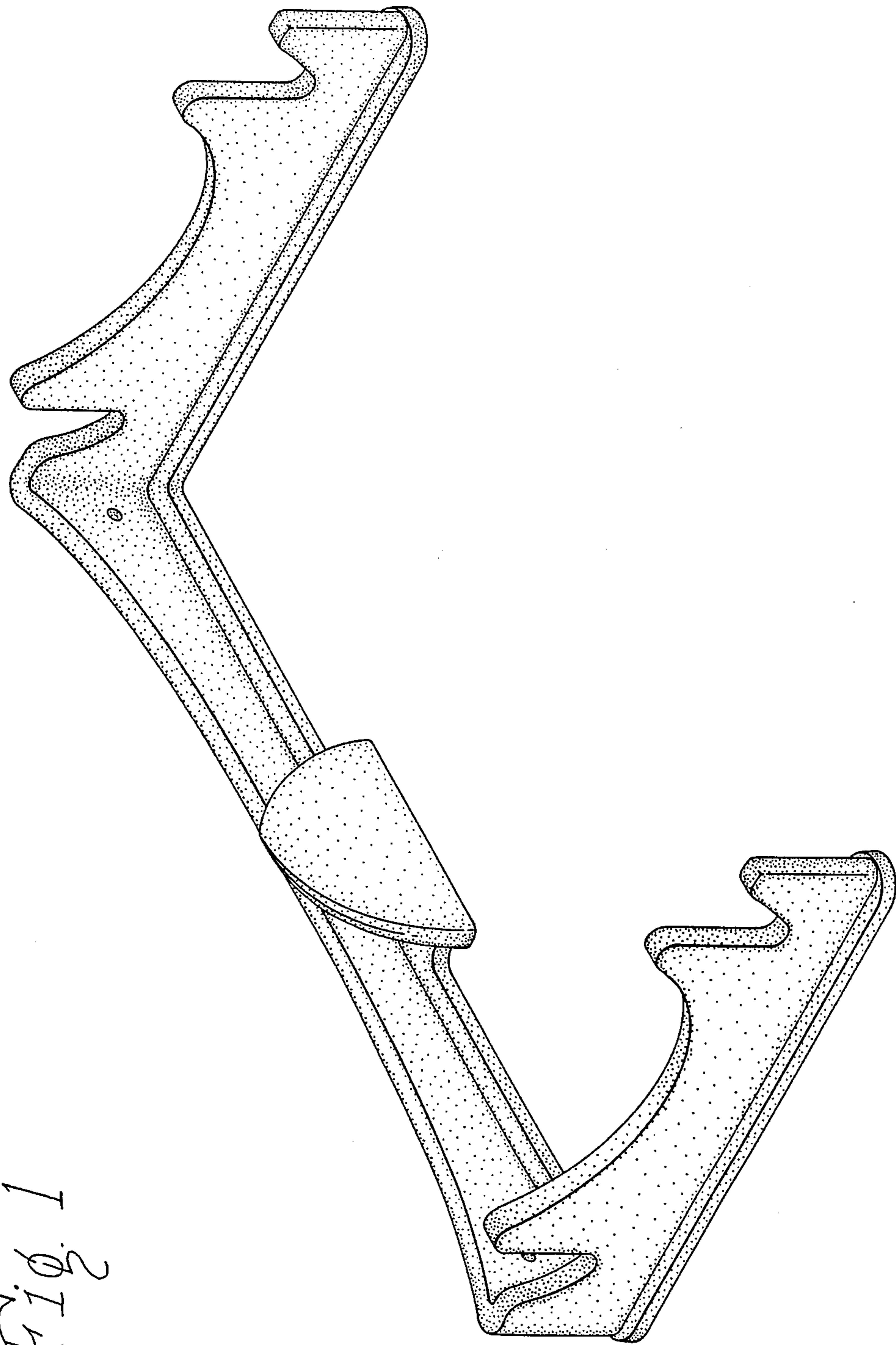

FIG. 1

Fig. 2

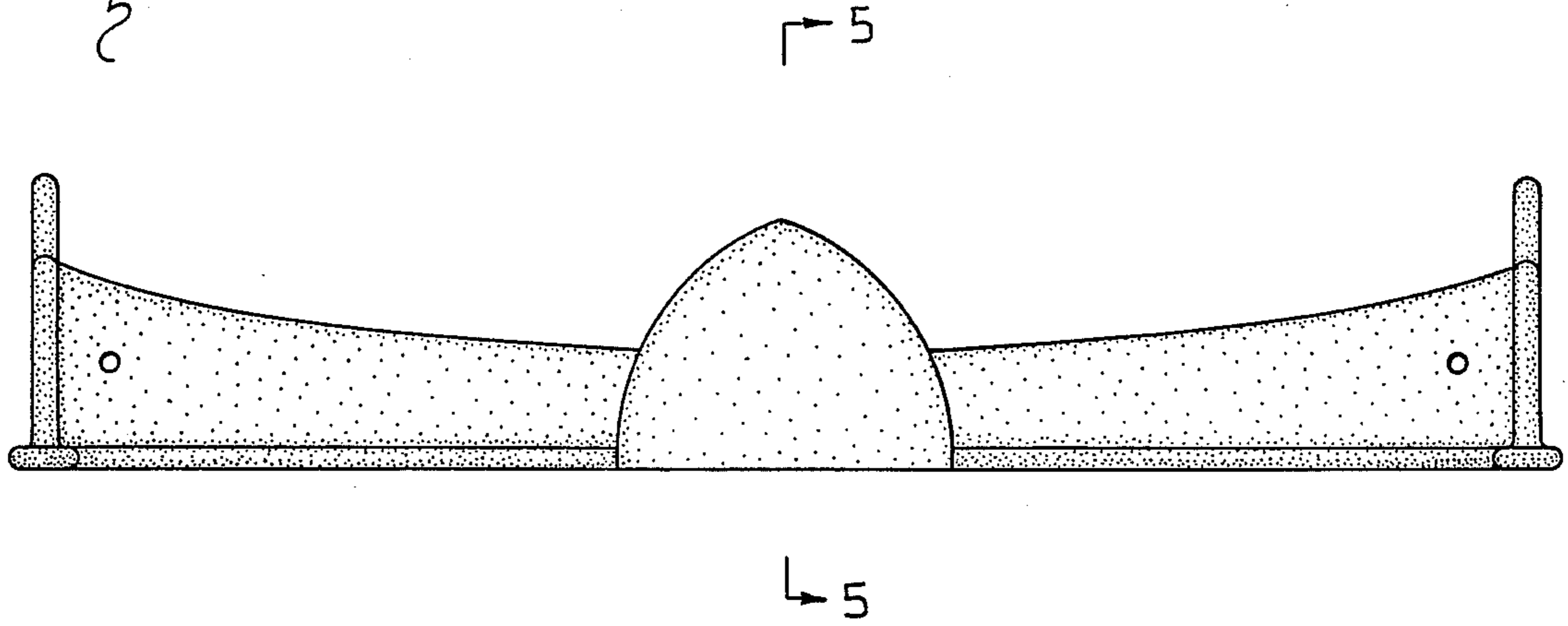

Fig. 3

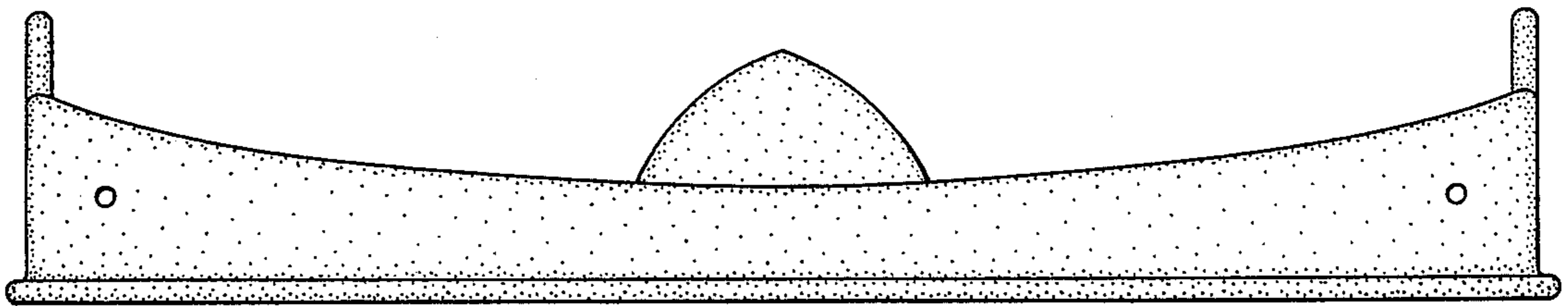

Fig. 4

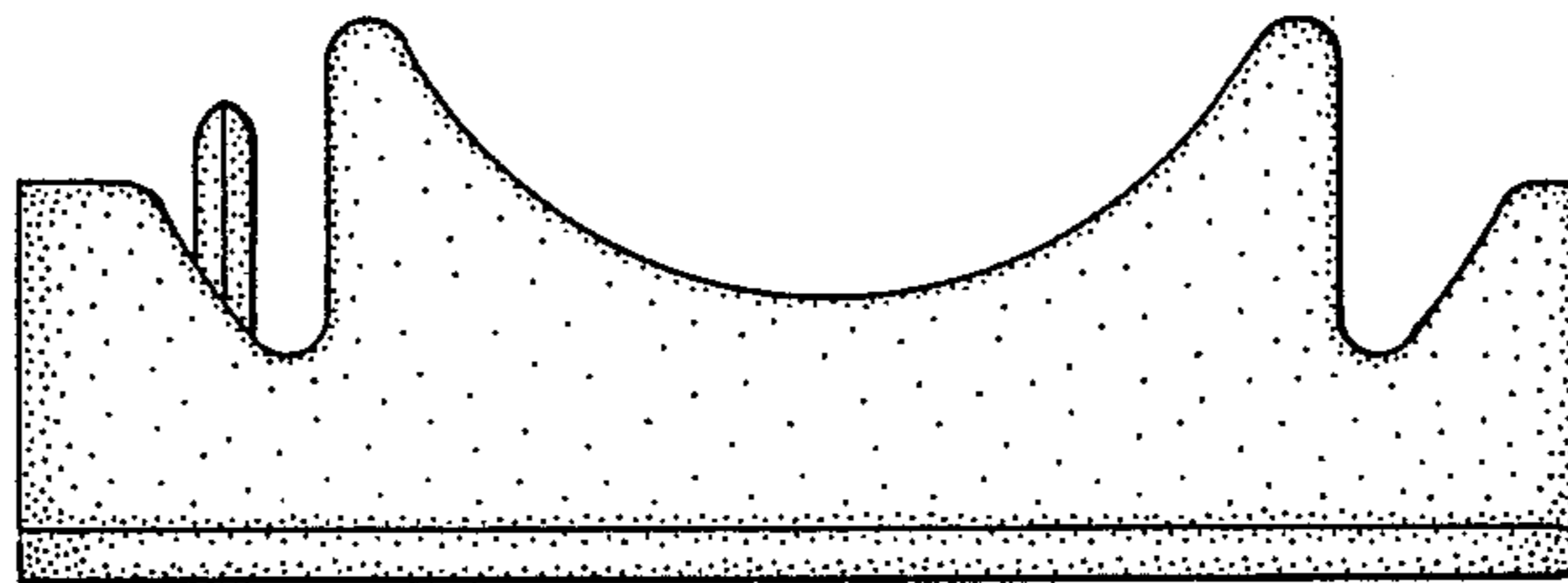
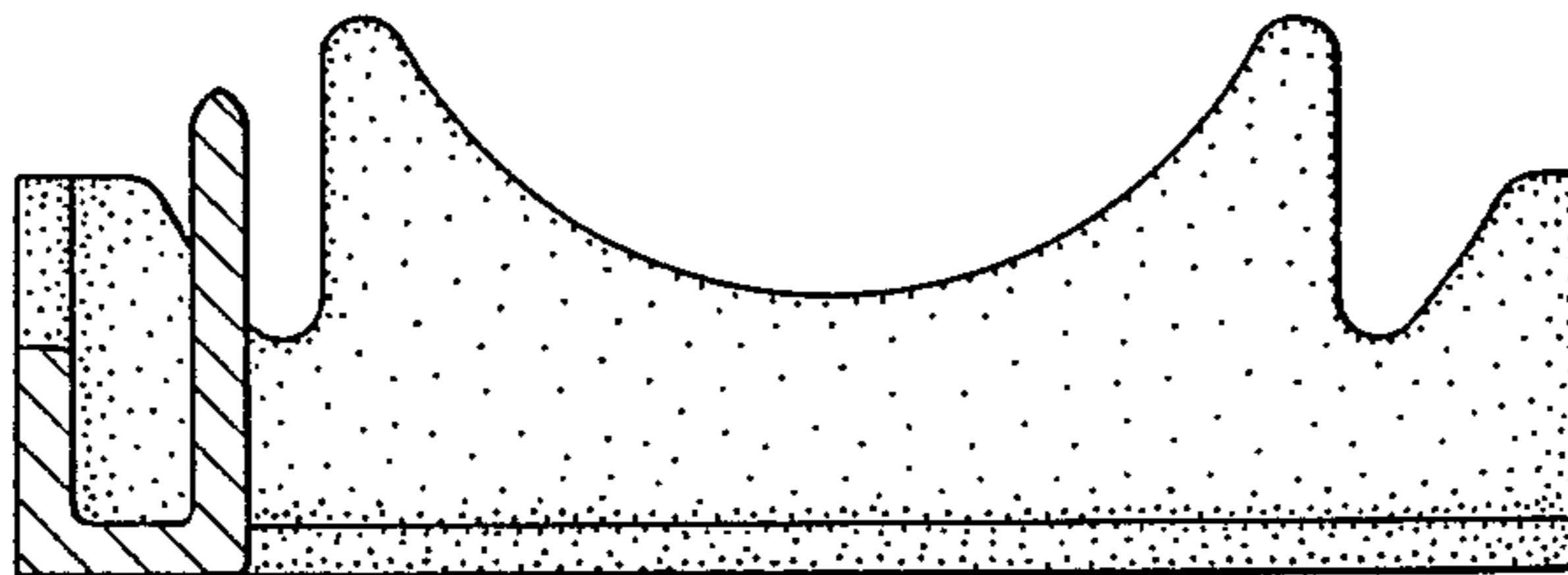

Fig. 5



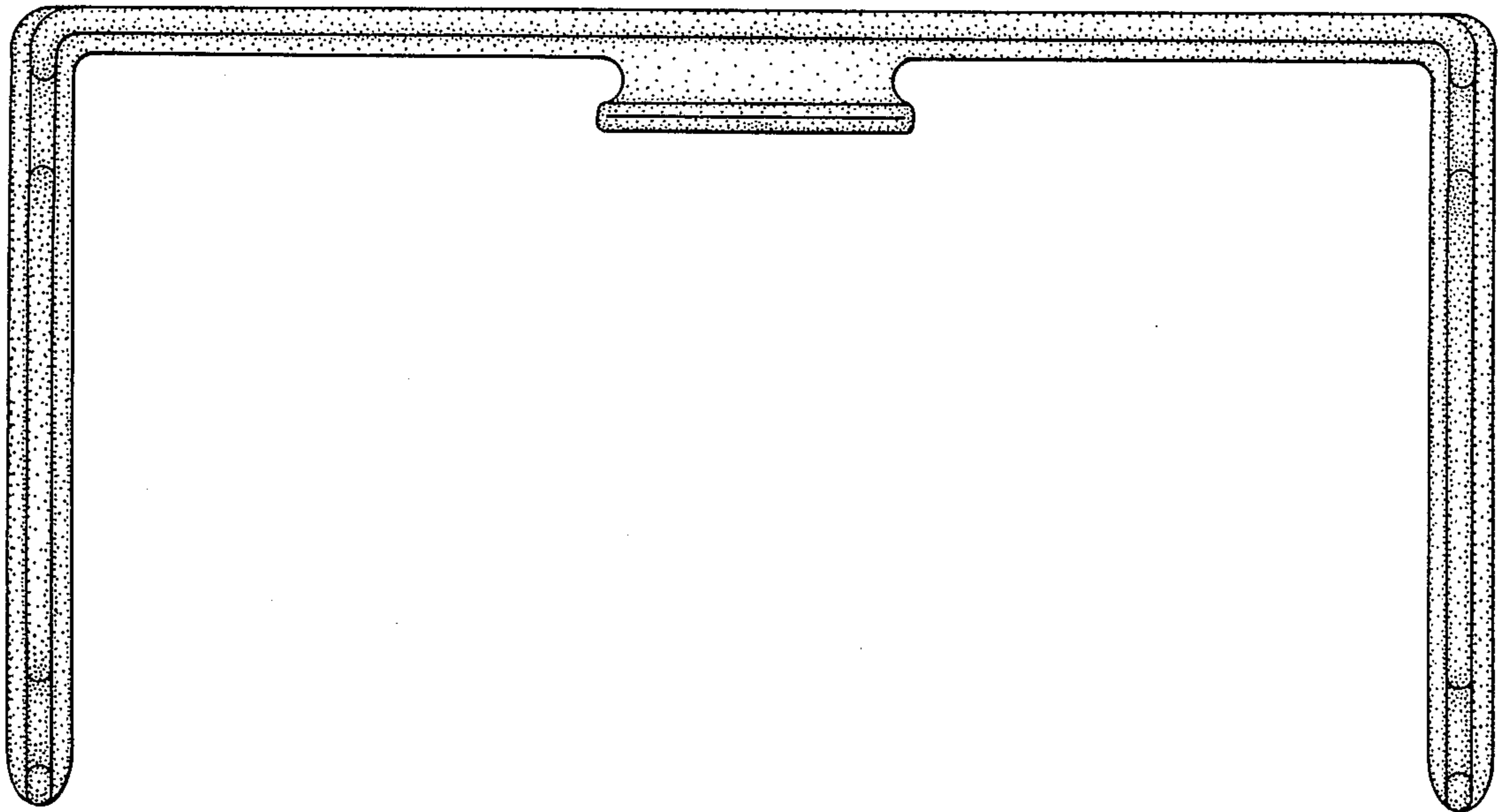

Fig. 6

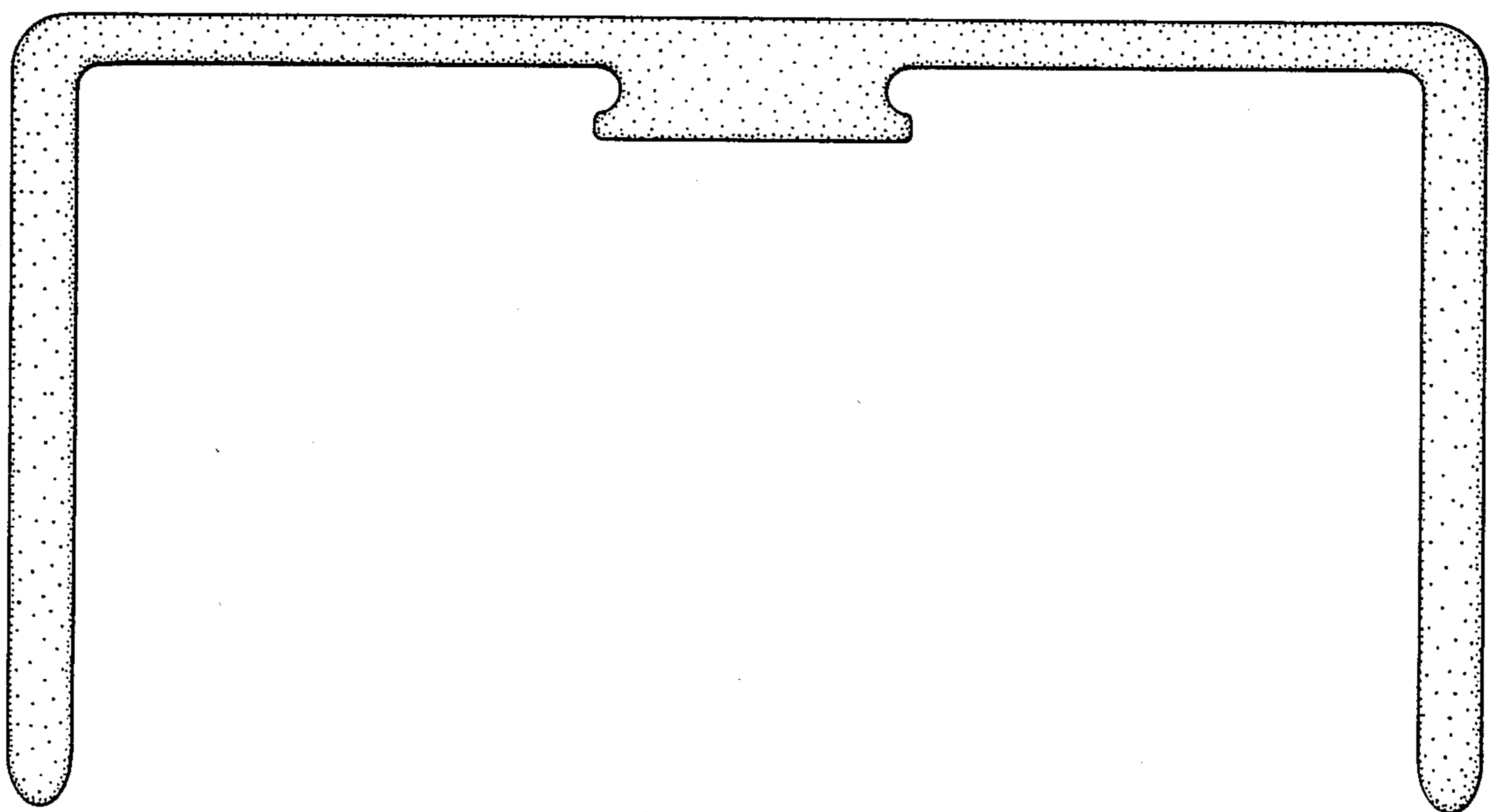

Fig. 7

Fig. 8

