

[54] WOOD AND COAL BURNING STOVE

[75] Inventors: Duncan C. Syme, Norwich; Vance R. Smith, Brookfield, both of Vt.

[73] Assignee: Vermont Castings, Inc., Randolph, Vt.

[**] Term: 14 Years

[21] Appl. No.: 25,795

[22] Filed: Mar. 13, 1987

[52] U.S. Cl. D23/346

[58] Field of Search D23/314, 342-350; 126/120-122, 126, 138-143, 190, 200

[56] References Cited

U.S. PATENT DOCUMENTS

D. 250,203	11/1978	Syme	D23/343
D. 275,878	10/1984	Syme et al.	D23/343
D. 276,457	11/1984	Heger	D23/343
D. 286,321	10/1986	Catry	D23/346
D. 293,463	12/1987	Bastien	D23/346

OTHER PUBLICATIONS

U.S. Stove Company brochure (1980)-Franklin Fireplace Model 261.

Primary Examiner—Susan J. Lucas
Assistant Examiner—Brian N. Vinson
Attorney, Agent, or Firm—Wolf, Greenfield & Sacks

[57] CLAIM

The ornamental design for a wood and coal burning stove, as shown and described.

DESCRIPTION

FIG. 1 is a perspective view of a wood and coal burning stove showing our new design;
FIG. 2 is a front elevational view thereof;
FIG. 3 is a top plan view thereof;
FIG. 4 is a right side elevational view thereof;
FIG. 5 is a left side elevational view thereof;
FIG. 6 is a rear elevational view thereof; and
FIG. 7 is a bottom plan view thereof.

The grillwork and diamond-pattern ornamentation in FIGS. 4 and 5 is understood to cover the entire surface represented as shown in FIG. 1.

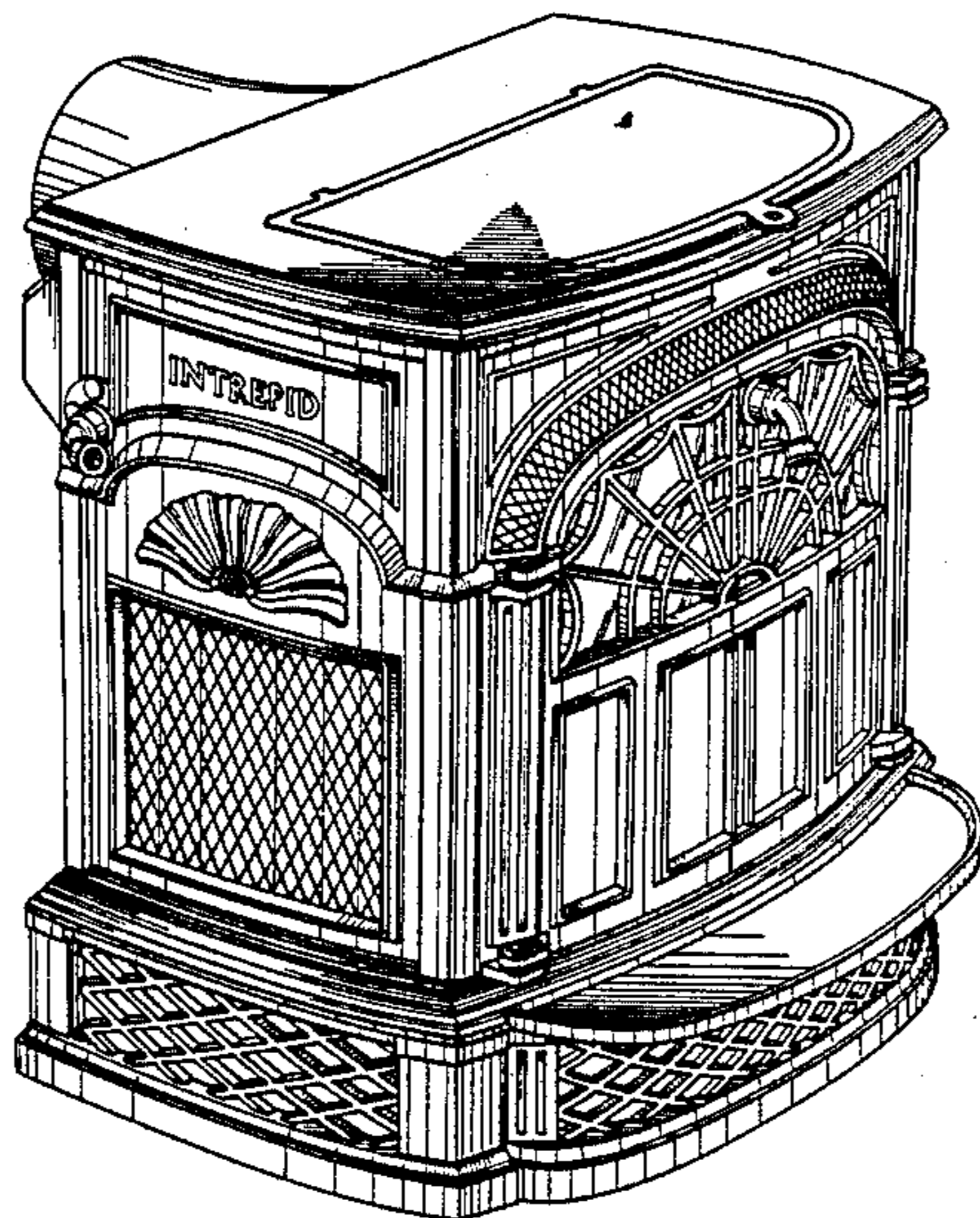

Fig. 1

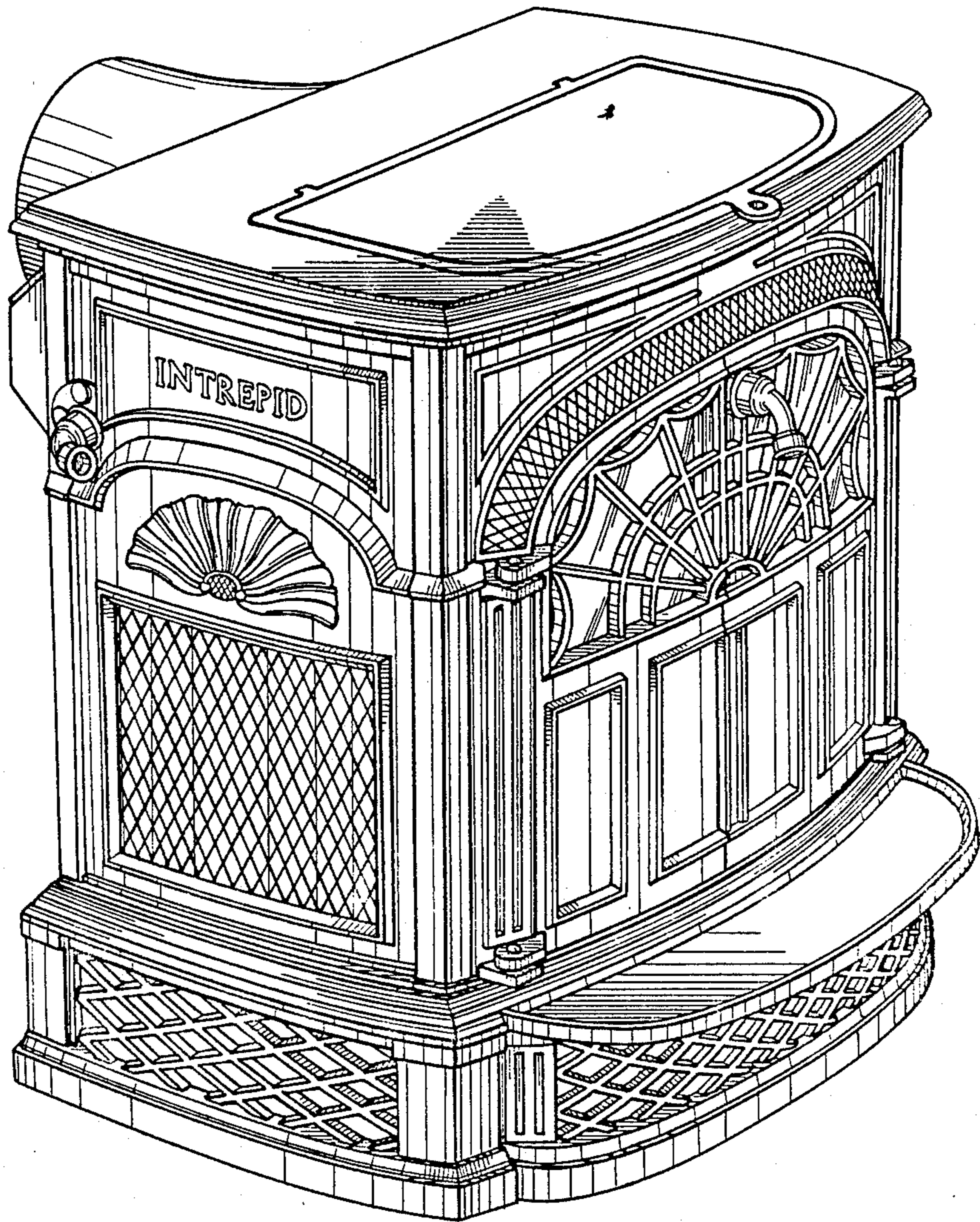

Fig. 2

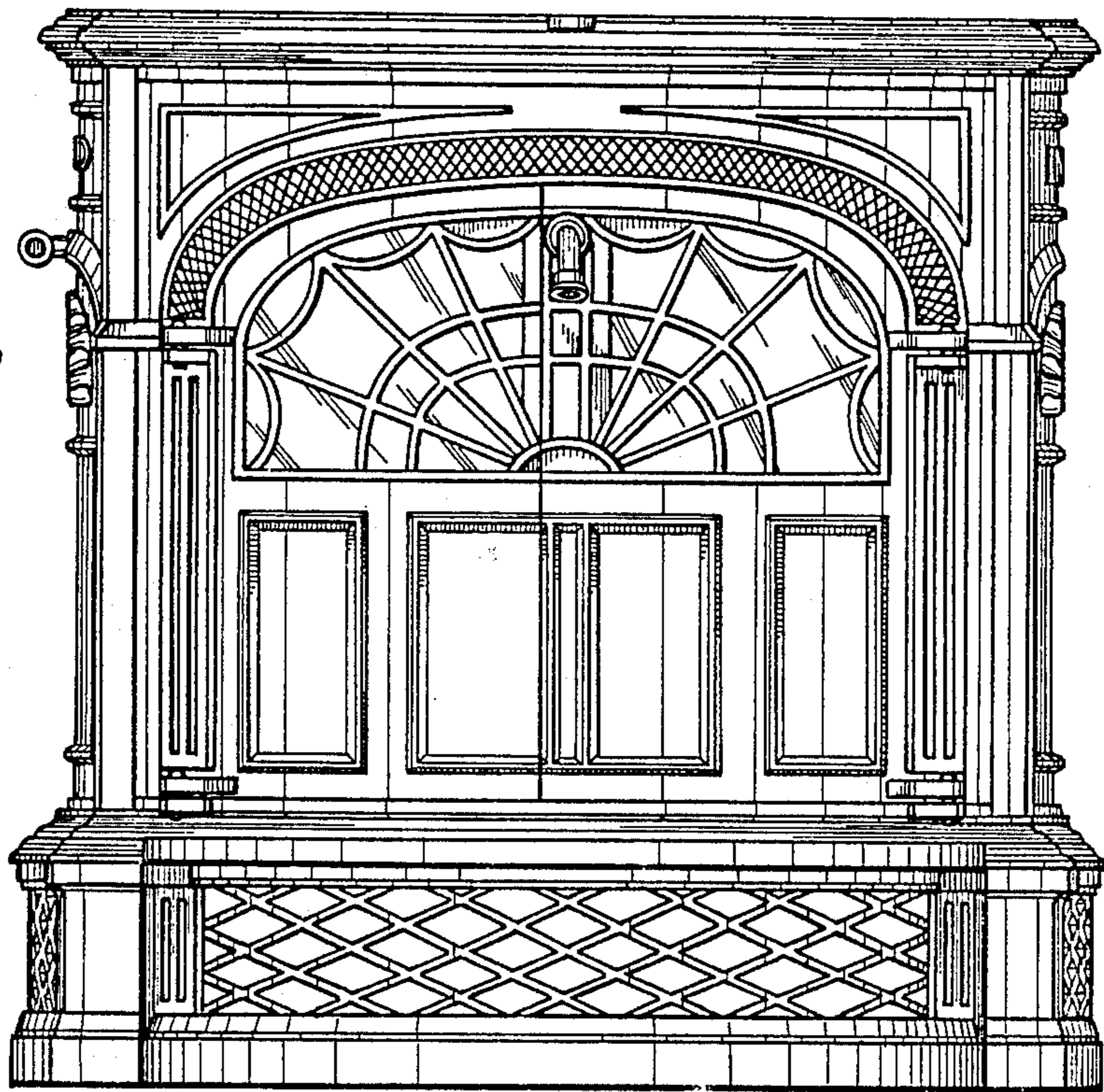

Fig. 3

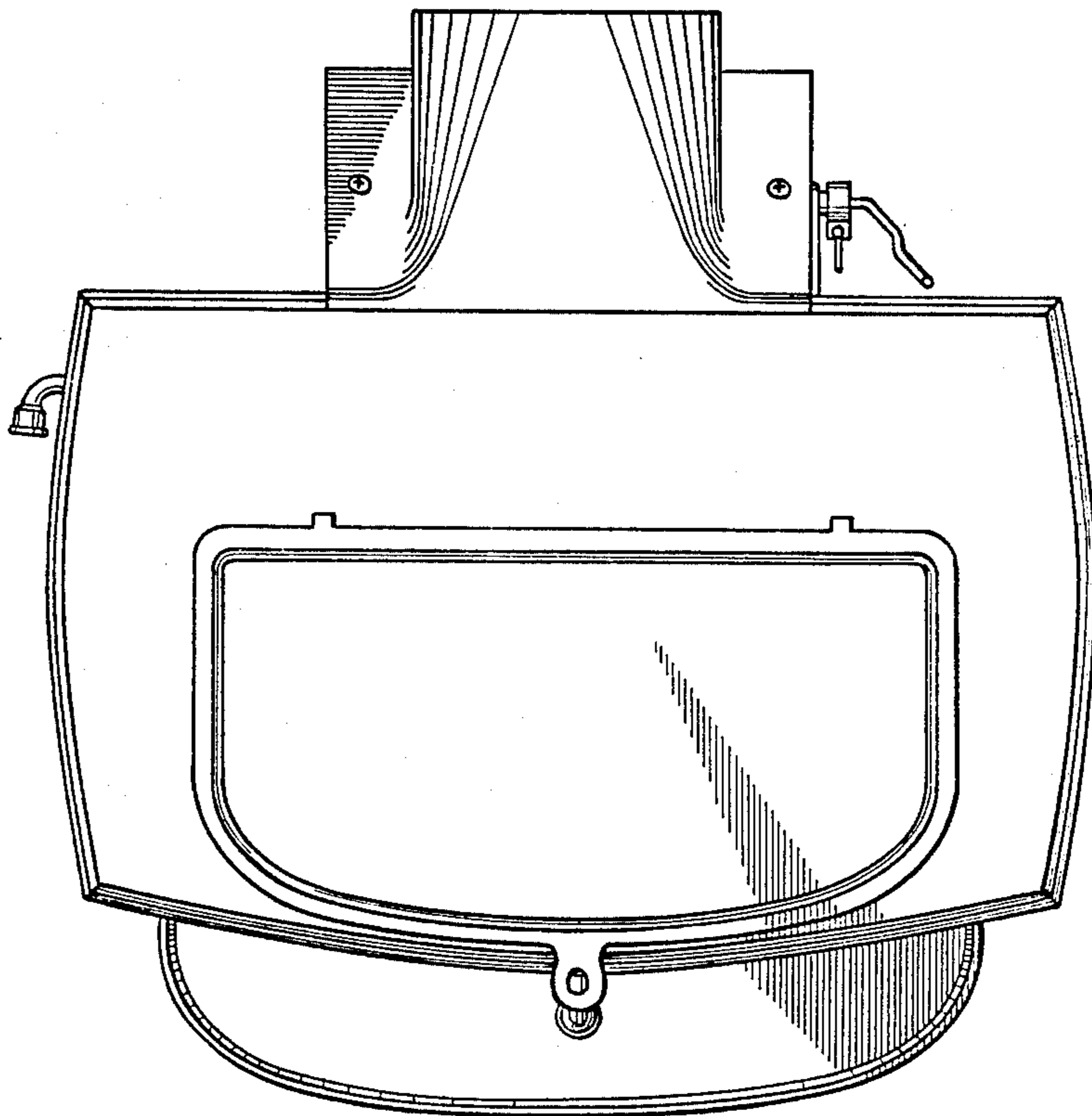

Fig. 4

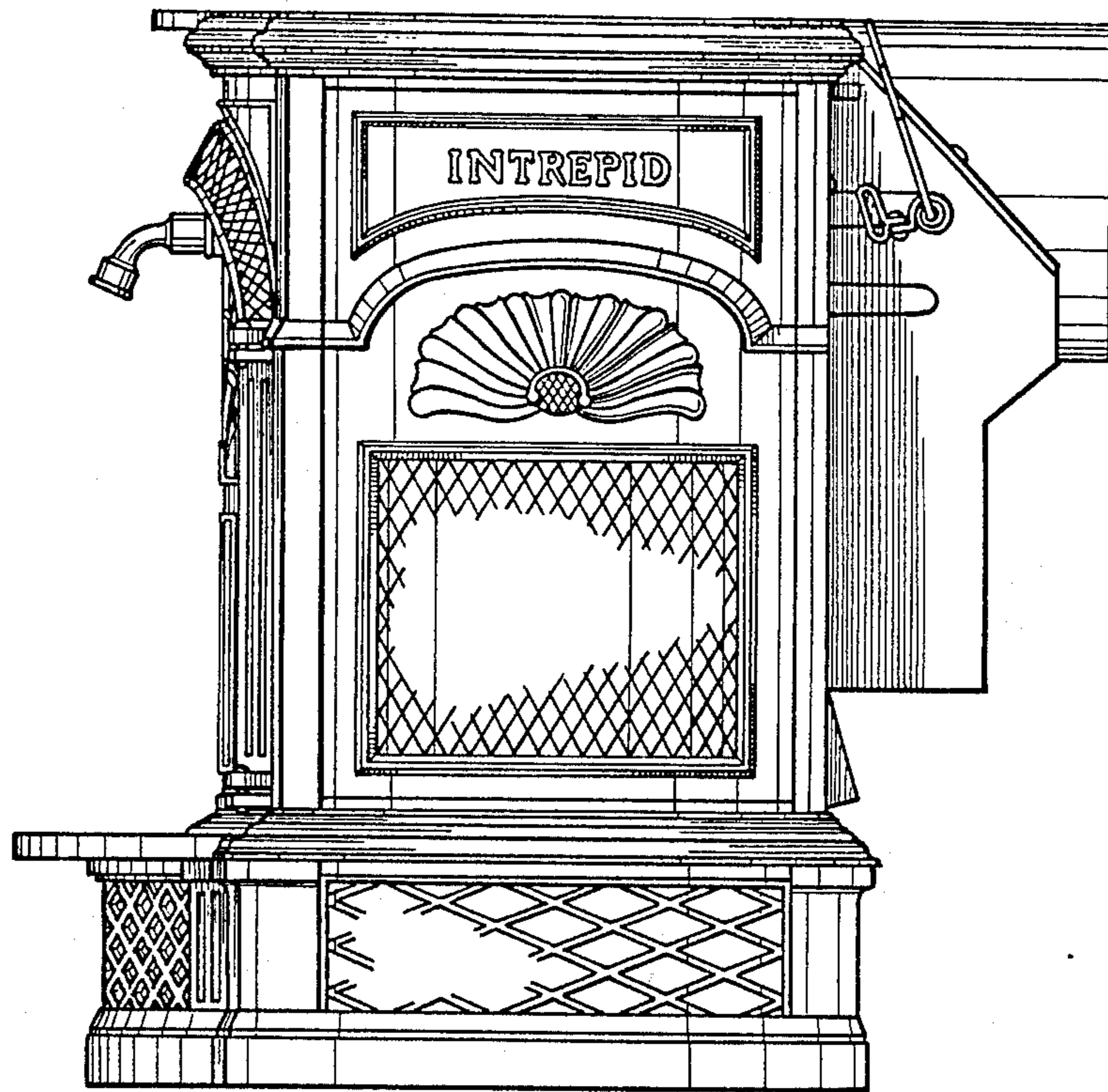

Fig. 5

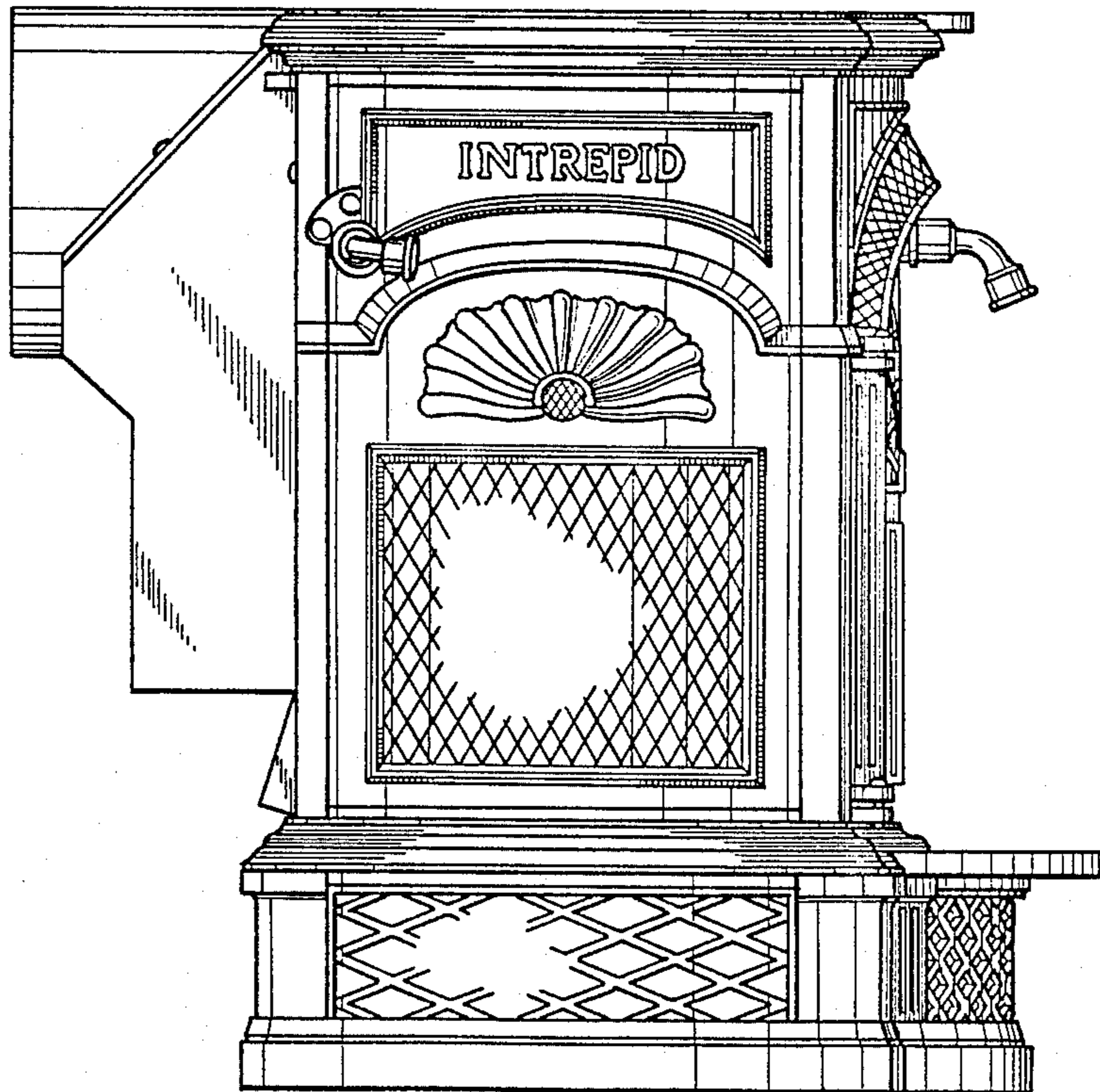

Fig. 6

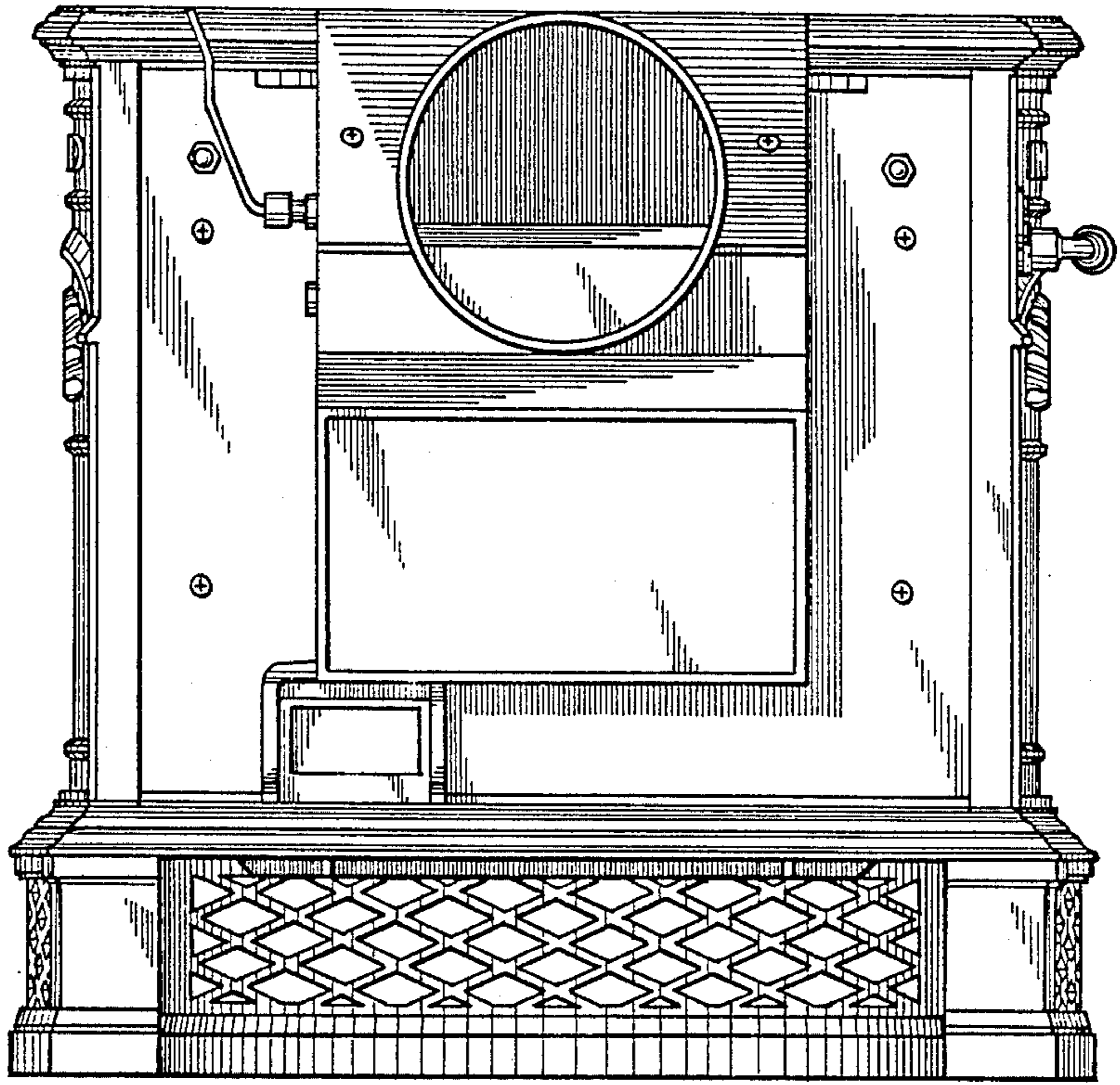

Fig. 7

