

[54] COMBINED SPOUT AND HANDLE SET

[75] Inventor: Stanley M. Paul, Rye, N.Y.

[73] Assignee: Paul Associates, Inc., Long Island City, N.Y.

[**] Term: 14 Years

[21] Appl. No.: 136,183

[22] Filed: Dec. 21, 1987

[52] U.S. Cl. D23/242

[58] Field of Search D23/238-243, D23/256-258; 4/191, 192; 137/801

[56] References Cited

U.S. PATENT DOCUMENTS

D. 265,229	6/1982	Paul	D23/242
D. 265,230	6/1982	Paul	D23/241
D. 265,231	6/1987	Paul	D23/241
D. 267,111	11/1982	Arnolds	D23/242
D. 271,514	11/1983	Paul	D23/242
D. 278,458	4/1985	Paul	D23/242

D. 279,213	6/1985	Paul	D23/242
D. 280,232	8/1985	Paul	D23/242
D. 280,437	9/1985	Rademacher	D23/242
D. 287,160	12/1986	Rademacher	D23/242
D. 290,159	6/1987	Jans	D23/242

Primary Examiner—James R. Largen
Attorney, Agent, or Firm—Darby & Darby

[57] CLAIM

The ornamental design for a combined spout and handle set, as shown and described.

DESCRIPTION

FIG. 1 is top perspective view of a combined spout and handle set showing my new design; FIG. 2 is a top plan view thereof; FIG. 3 is a front elevational view thereof; FIG. 4 is a left side elevational view thereof the right side being a mirror image of the left side down; FIG. 5 is a rear elevational view thereof; FIG. 6 is a bottom plan view thereof; and FIG. 7 is a top perspective view of a modified form of the combined spout and handle set shown in FIGS. 1-6.

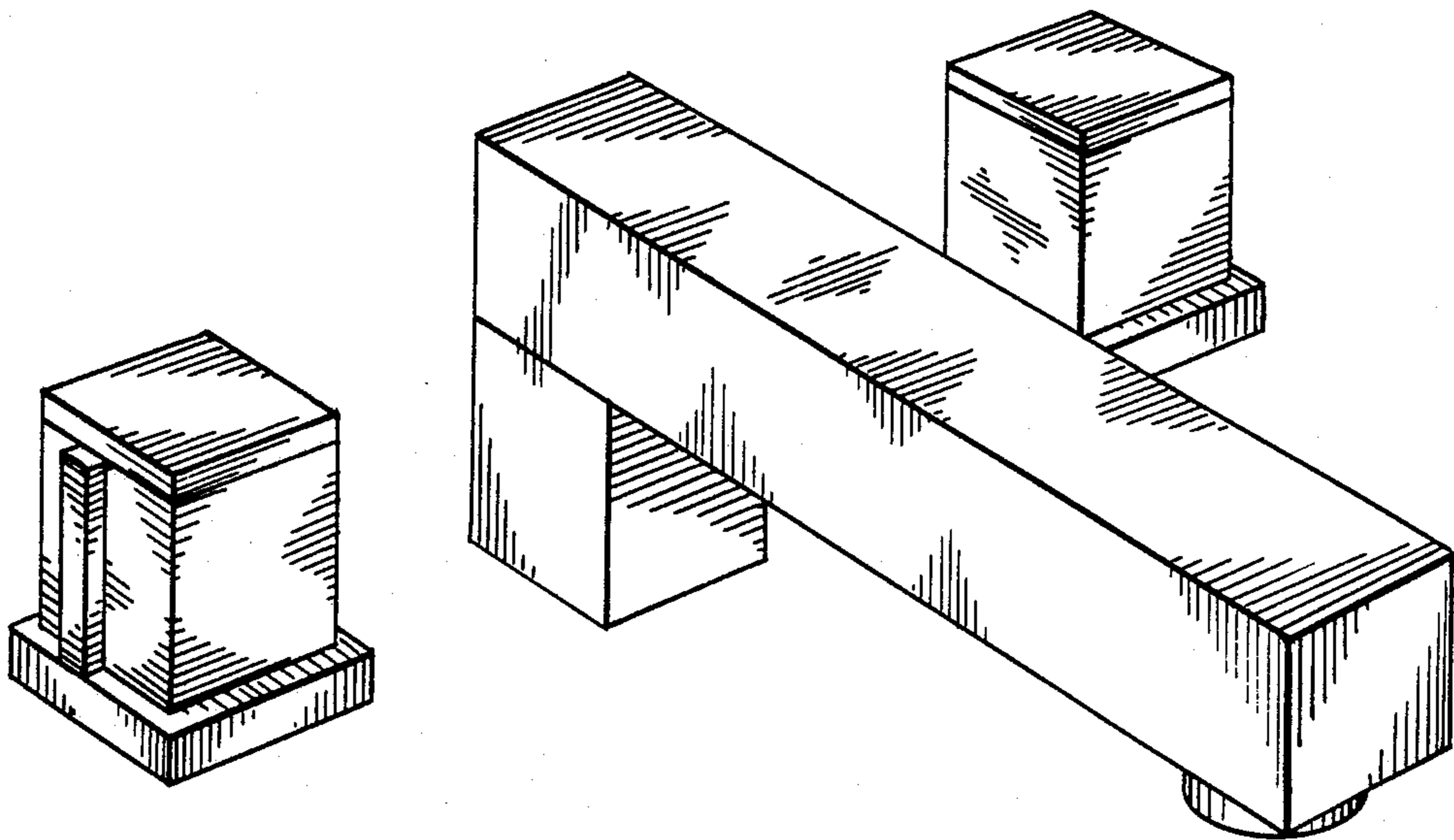

FIG. 1

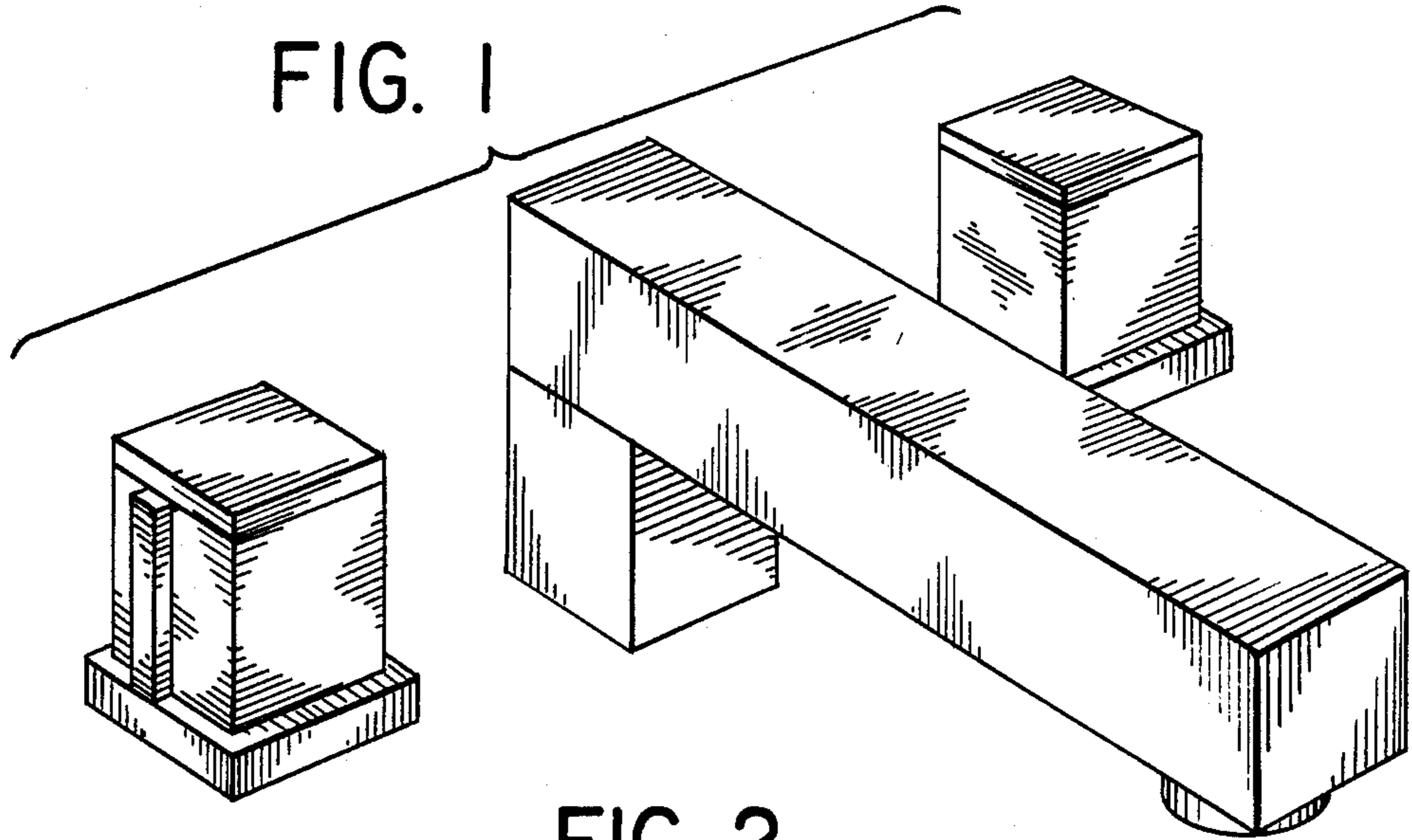

FIG. 2

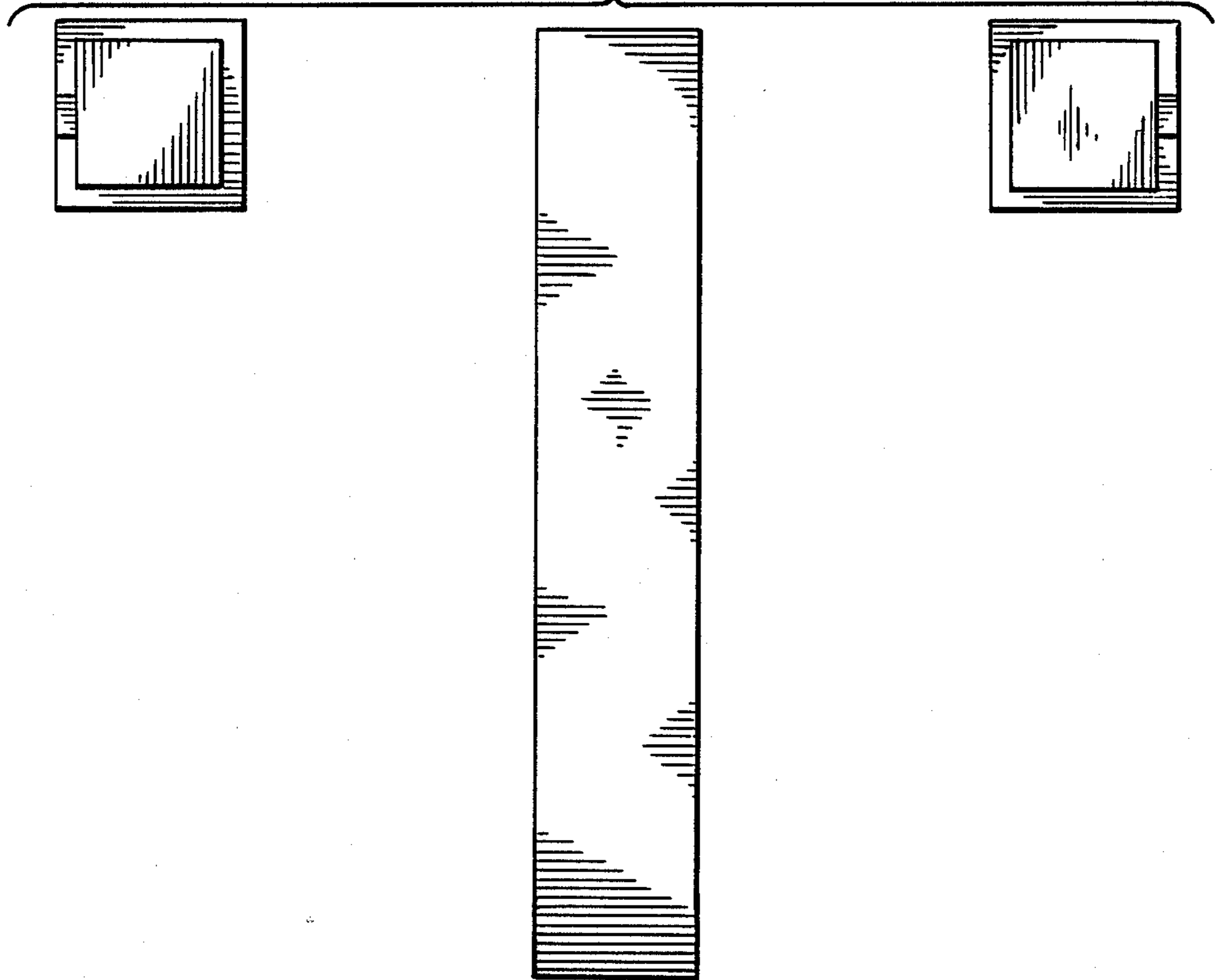

FIG. 3

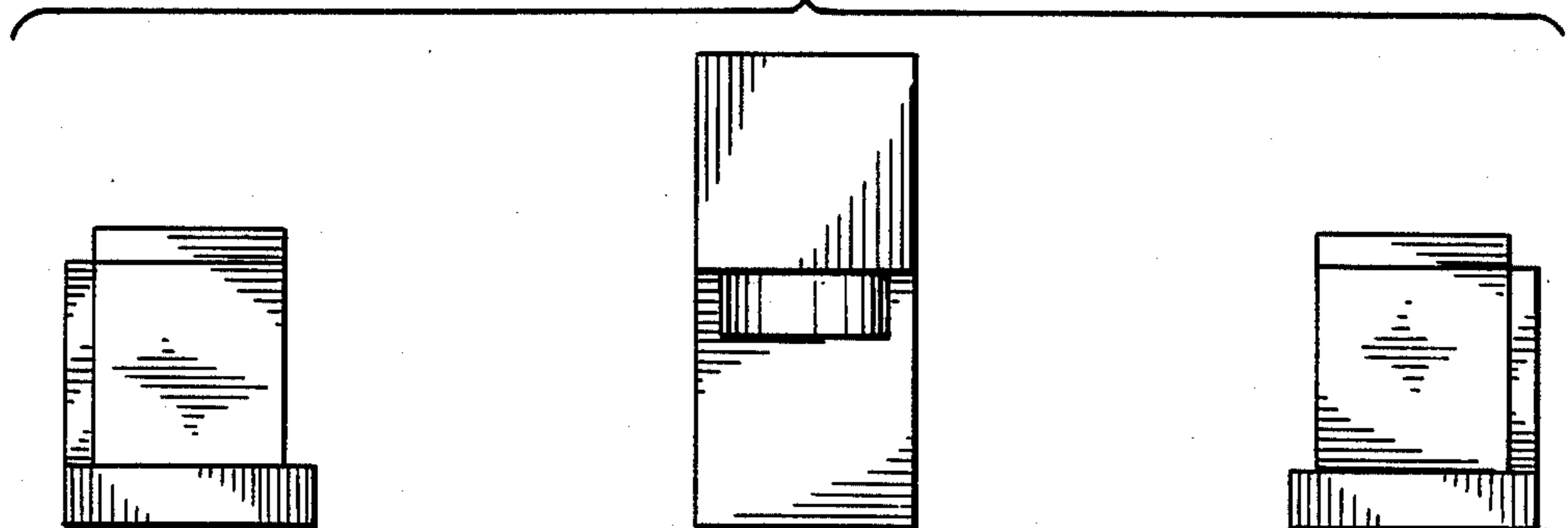

FIG. 4

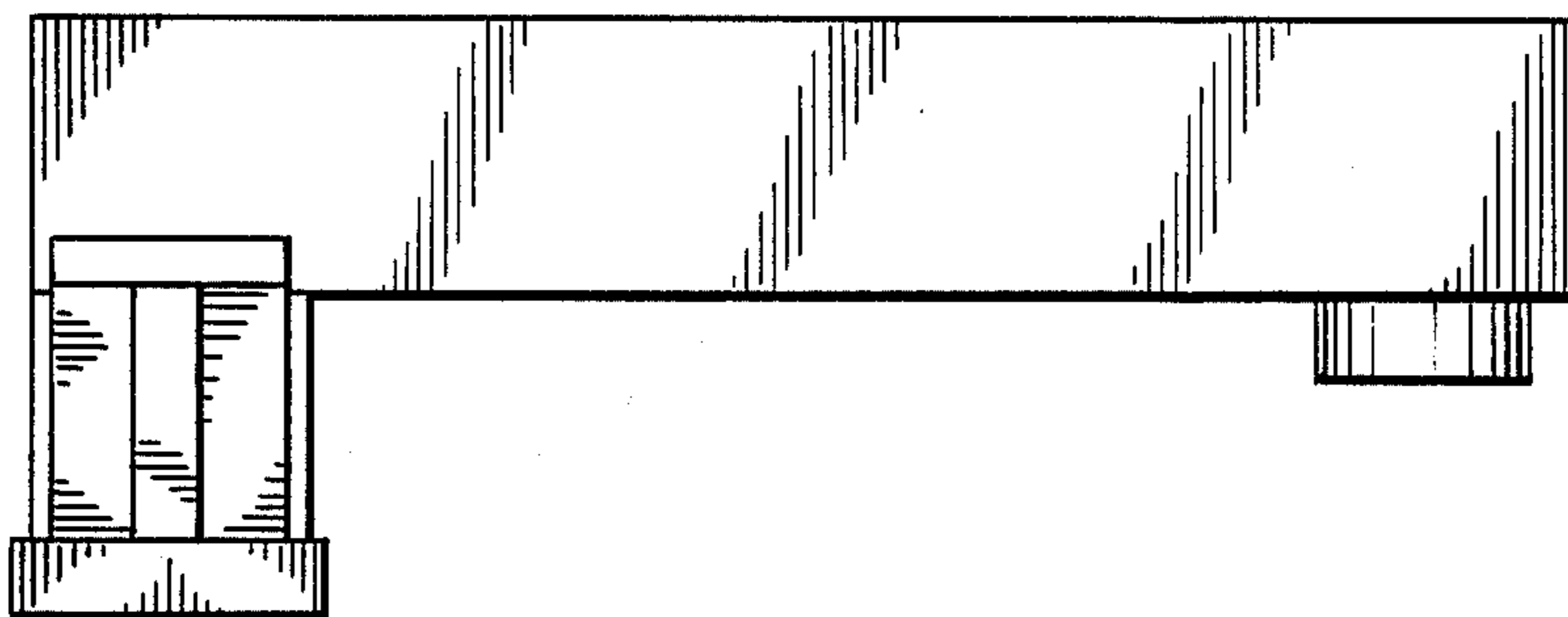

FIG. 5

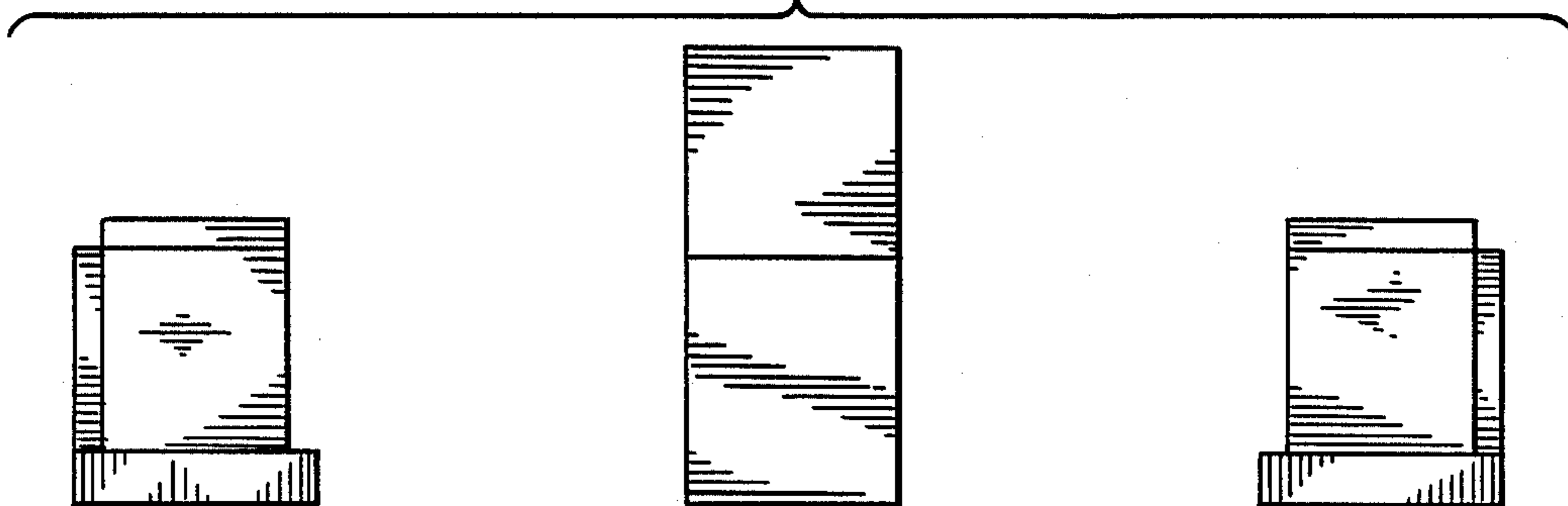

FIG. 6

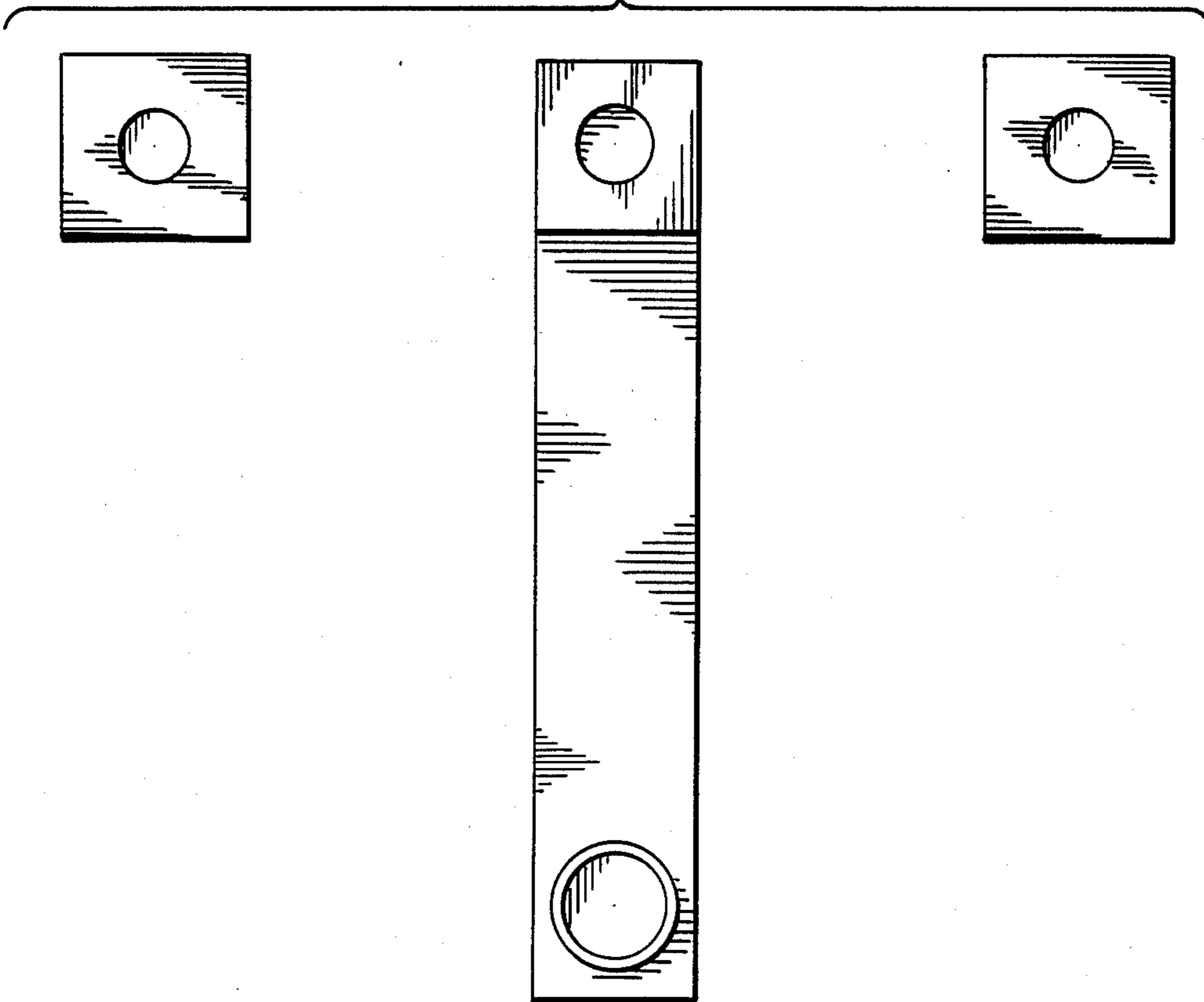

FIG. 7

