

[54] WALL MOUNT, COIN-OPERATED, PUBLIC TELEPHONE

[75] Inventors: Hiroyuki Yamazaki, Tokyo; Yutaka Yoshino, Isehara; Makoto Gotoh, Atsugi, all of Japan

[73] Assignee: Anritsu Corporation, Tokyo, Japan

[**] Term: 14 Years

[21] Appl. No.: 99,511

[22] Filed: Sep. 22, 1987

[52] U.S. Cl. D14/146

[58] Field of Search D14/55; 379/453, 150, 379/146, 153

[56] References Cited

U.S. PATENT DOCUMENTS

D. 197,974	4/1964	Dreyfuss	D14/55
D. 227,783	7/1973	Jarda et al.	D14/55
D. 270,260	8/1983	Appel et al.	D14/55
D. 283,890	5/1986	Britz et al.	D14/55
D. 291,566	8/1987	Perry et al.	D14/55
D. 294,144	2/1988	Chang	D14/55
571,590	11/1896	Gallagher, Jr.	379/153
4,518,830	5/1985	Drexler et al.	D14/55 UX
4,672,661	6/1987	Clark, Jr. et al.	379/144 X

OTHER PUBLICATIONS

"Public Telephone Products"; GTE Supply, copyright 1987.

"CCRC", Panel Enclosures; Phillips & Brooks, Inc.: Gladwin Inc; 161-1460; 1987.

"The Dual Solution"; Stromberg-Carlson; 1987, Phonocard; Landis & Gyr.

"Line Powered Universal Public Telephone Retrofit Kit", Protel, Inc., CPI-34190, 8/87.

"The MBA-A Credit Card Pay Phone System", Telemanagement, vol. II, No. 4.

"Ernest Telecom Specifications Model 7DW/7DW-VF/7EW-VF", The People's Choice Ernest Telecom.

Primary Examiner—Horace B. Fay, Jr.

Attorney, Agent, or Firm—Bacon & Thomas

[57] CLAIM

The ornamental design for wall mount, coin-operated, public telephone, as shown and described.

DESCRIPTION

FIG. 1 is a front and right side perspective view of a wall mount, coin-operated, public telephone showing our new design;

FIG. 2 is a perspective view like FIG. 1 with the handset removed from the console;

FIG. 3 is a front elevational view thereof;

FIG. 4 is a right side elevational view thereof;

FIG. 5 is a top plan view thereof;

FIG. 6 is a left side elevational view thereof;

FIG. 7 is a rear elevational view thereof; and

FIG. 8 is a bottom plan view thereof.

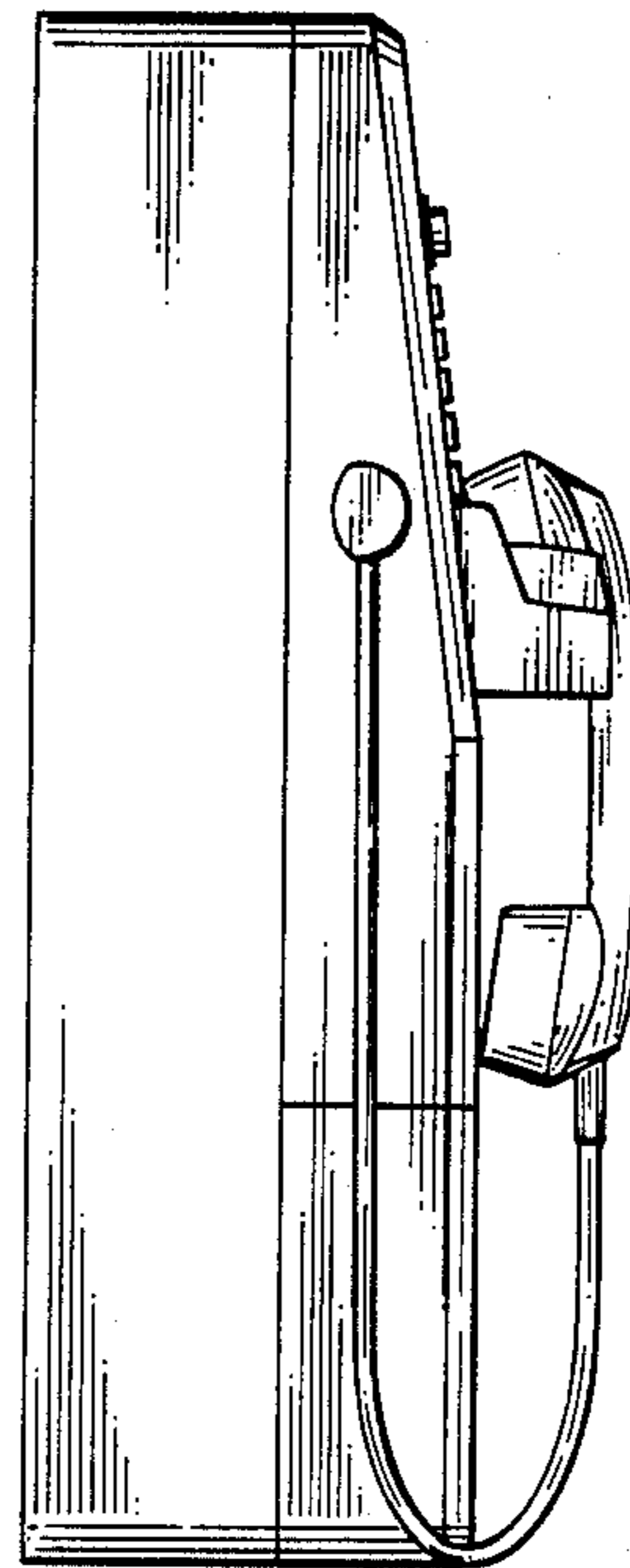
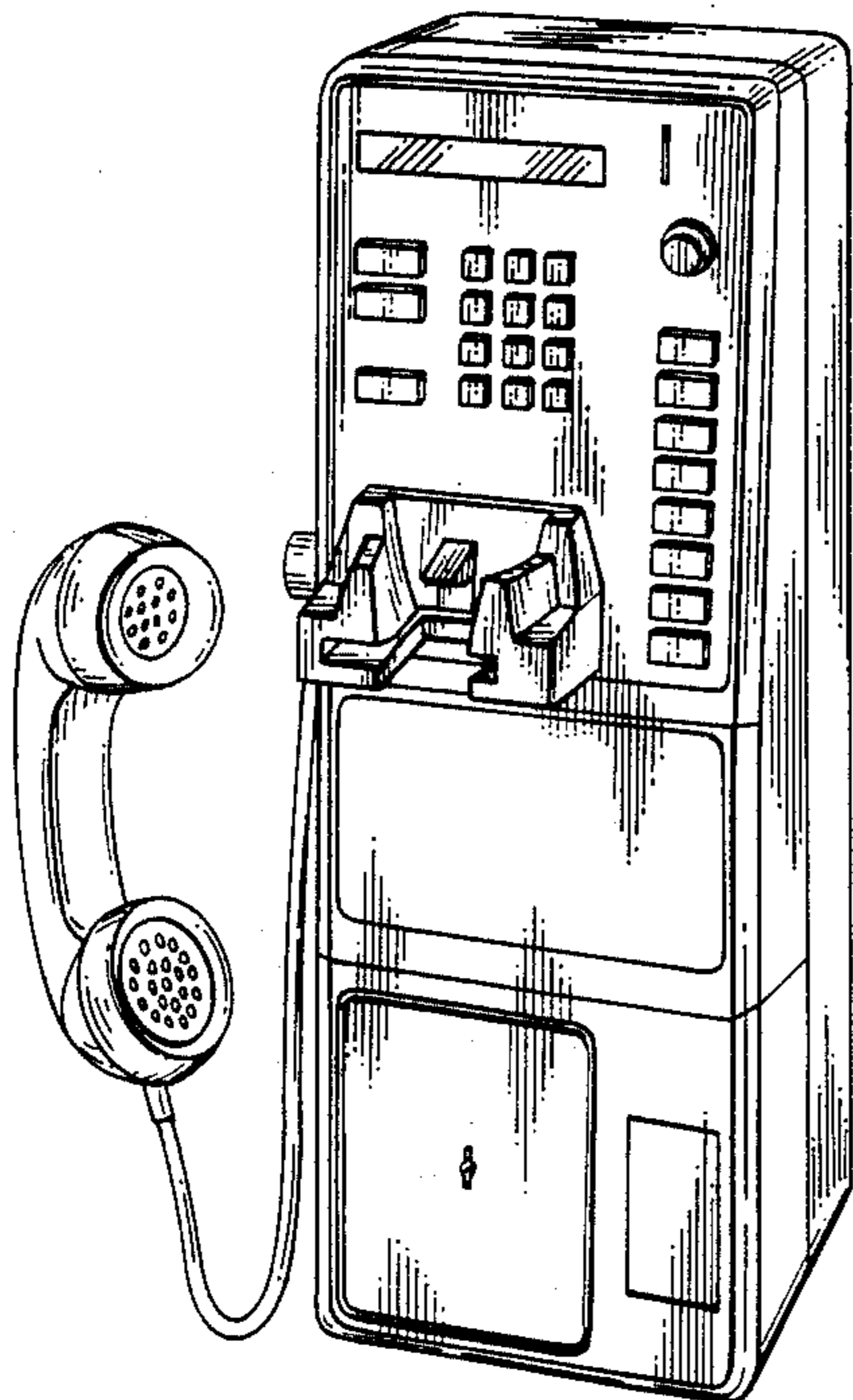

FIG. 1

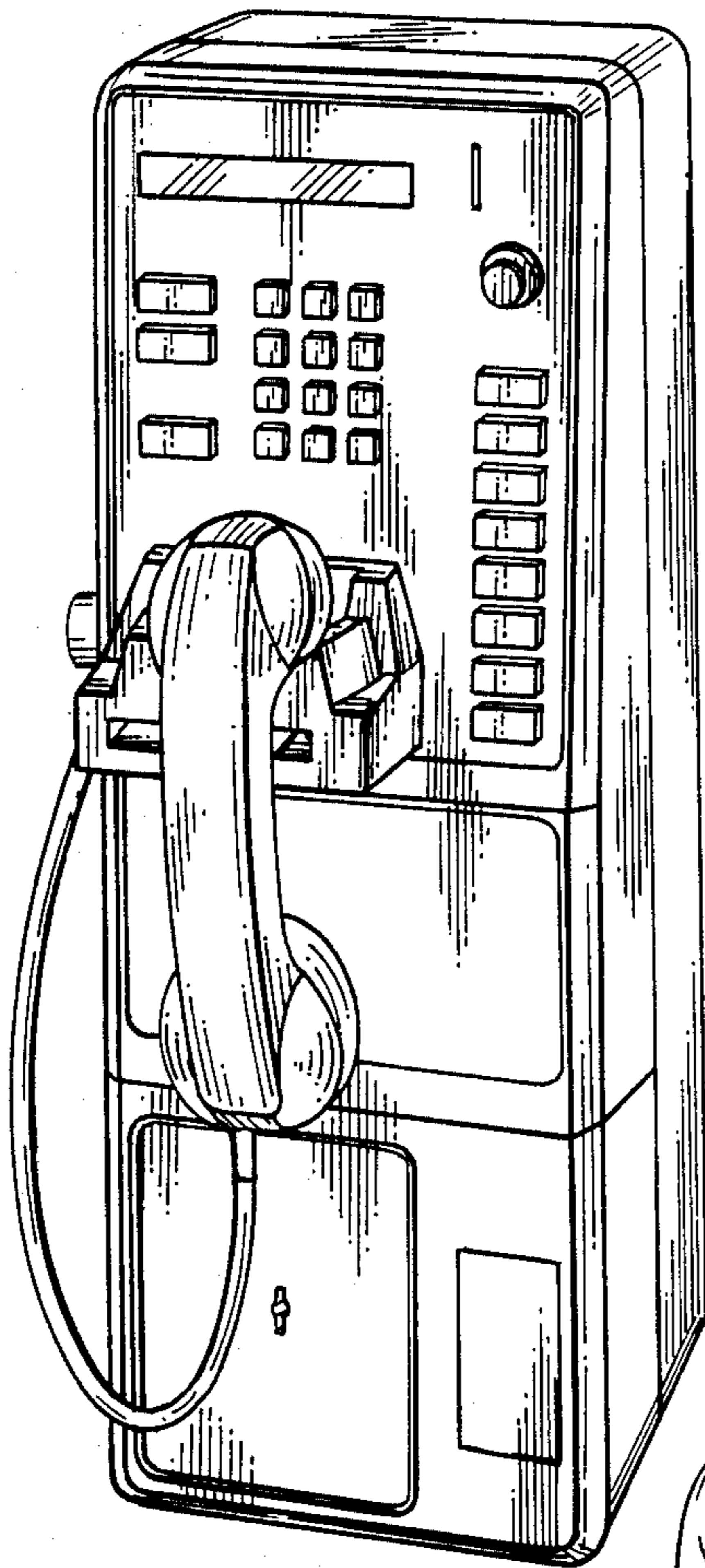

FIG. 2

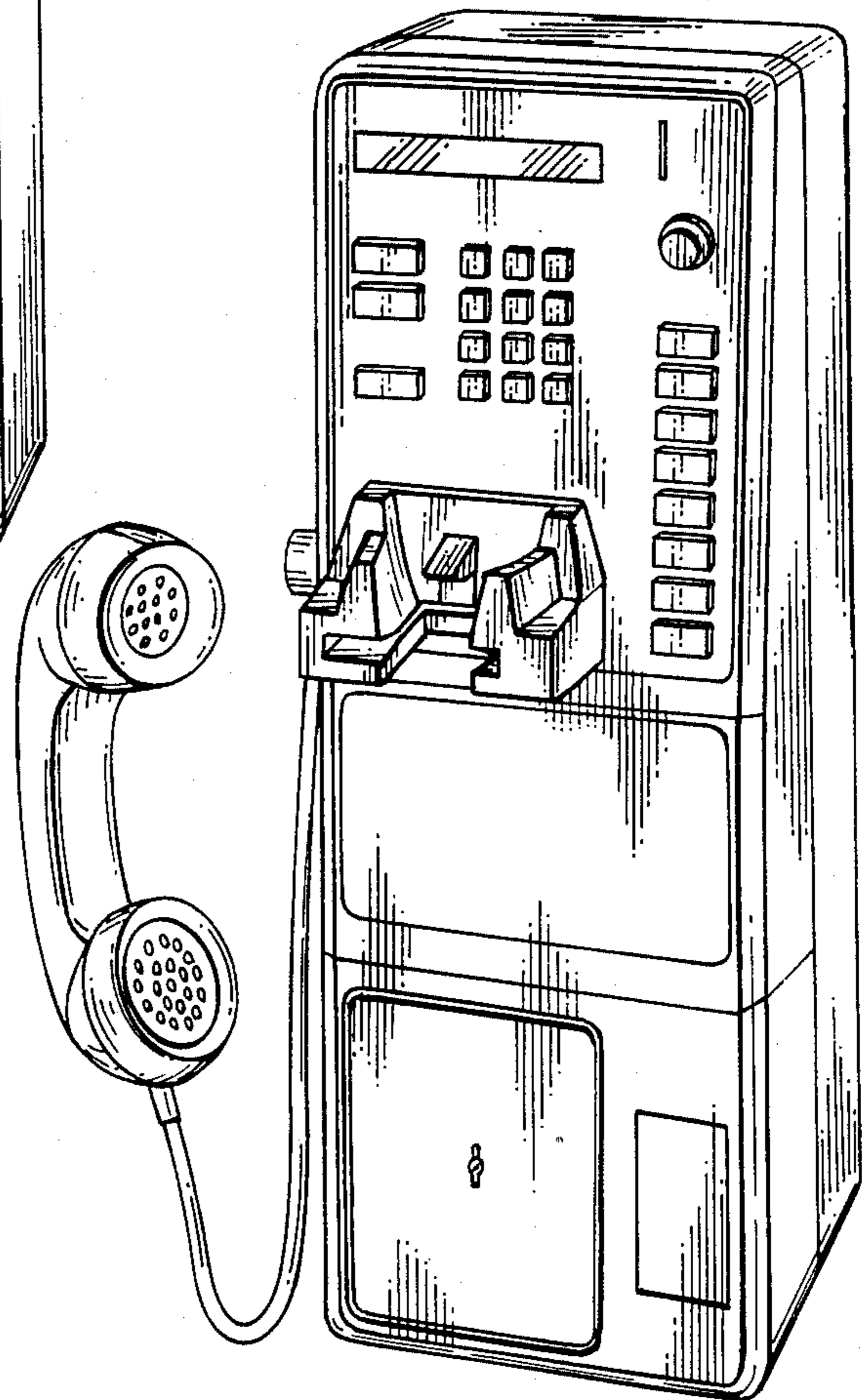

FIG. 3

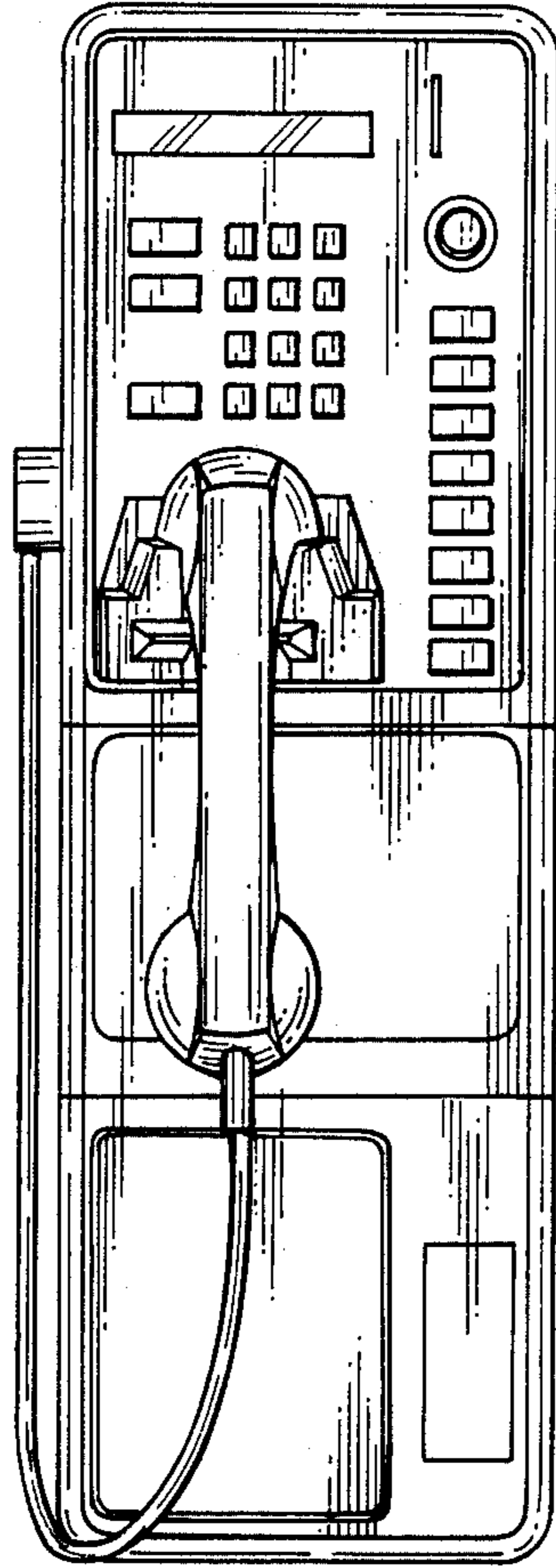

FIG. 4

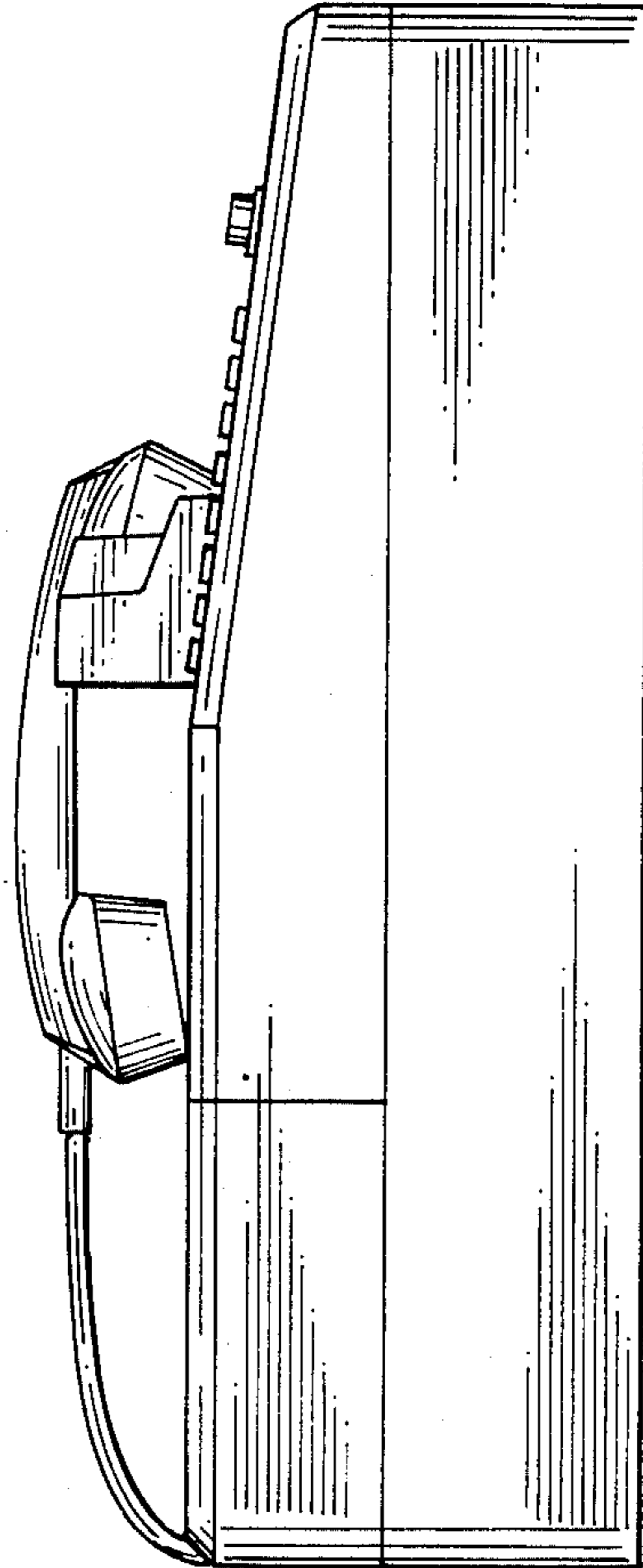

FIG. 5

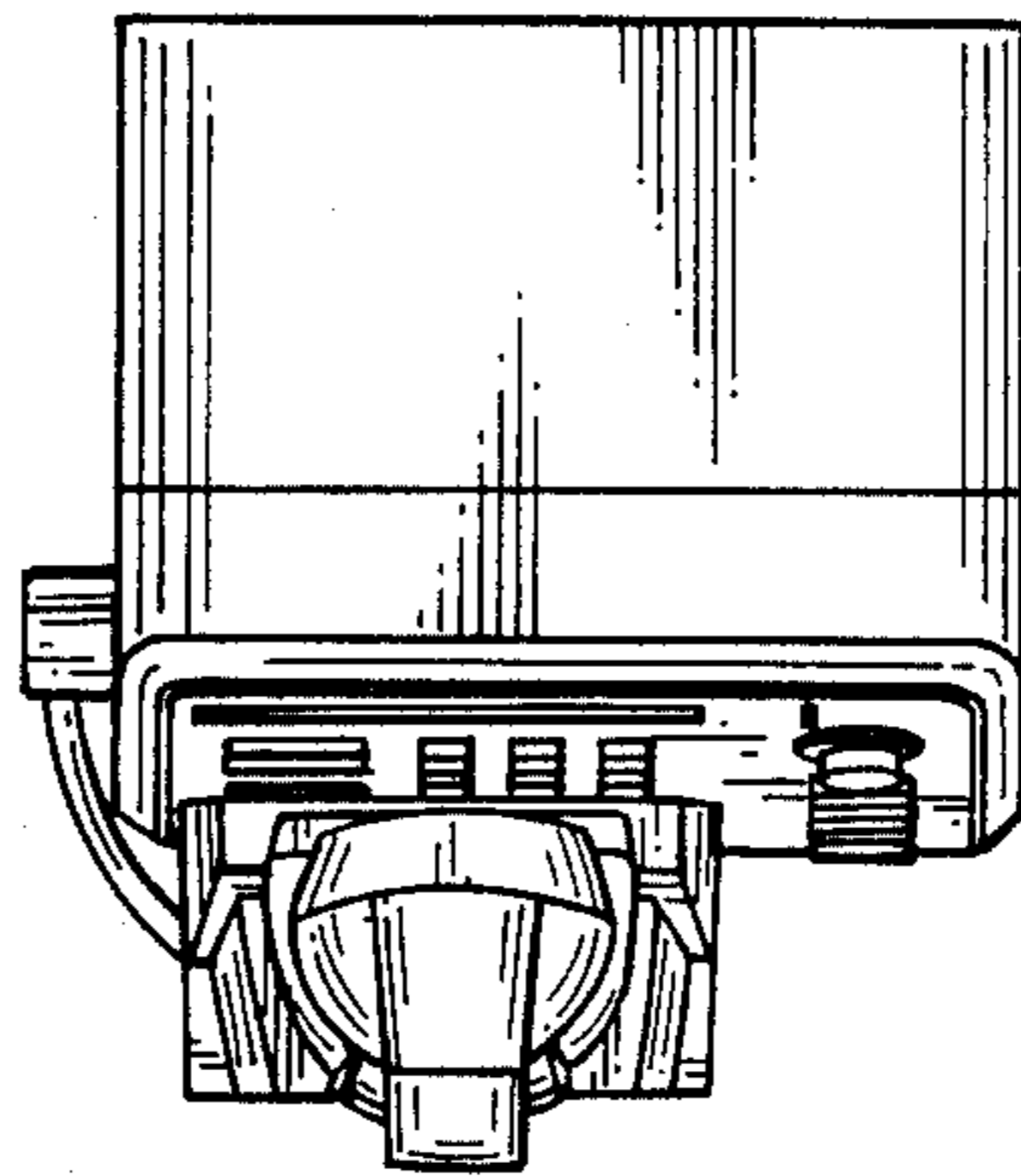

FIG. 6

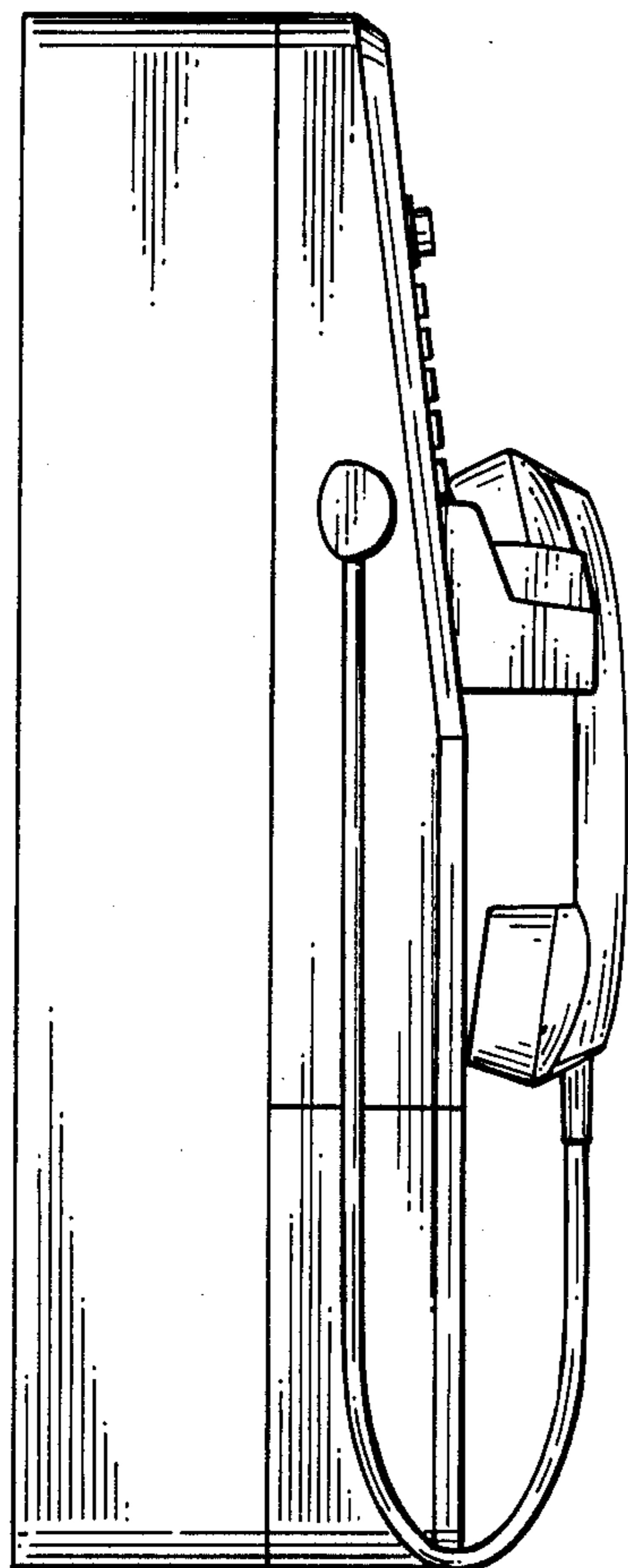

FIG. 7

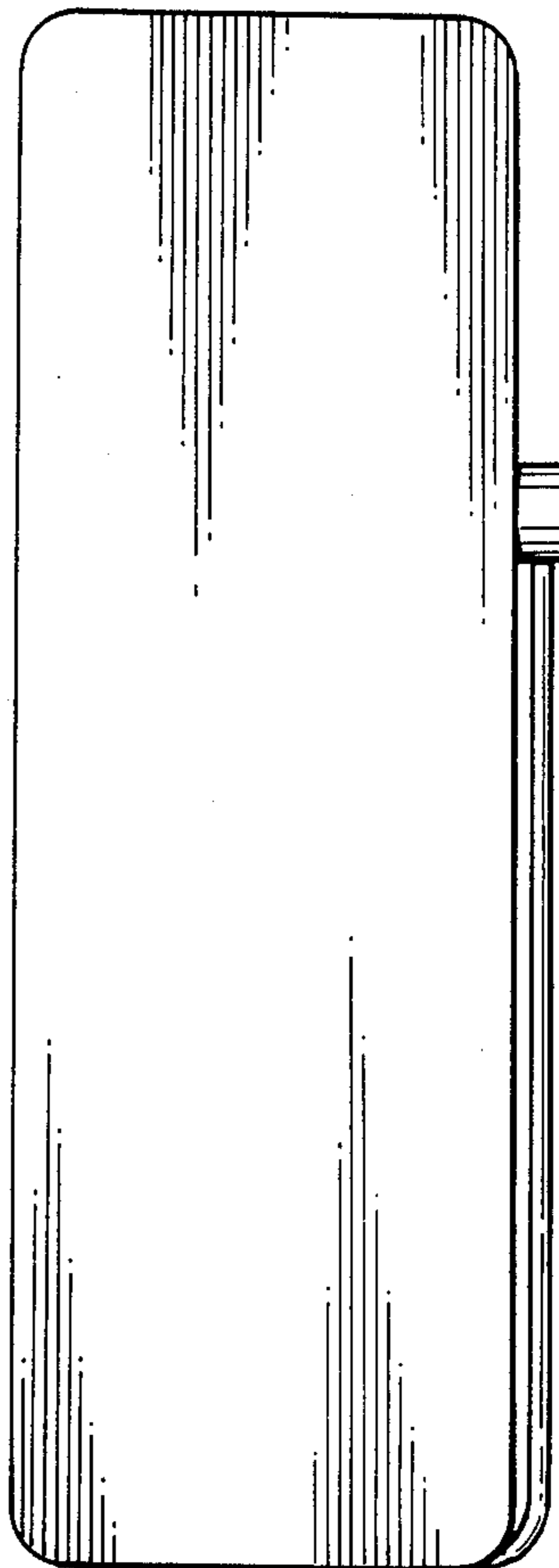

FIG. 8

