

[54] TELEPHONE SET

[75] Inventor: Ernst Thomke, Grenchen, Switzerland

[73] Assignee: Swatch S.A., Switzerland

[\*\*] Term: 14 Years

[21] Appl. No.: 107,516

[22] Filed: Oct. 9, 1987

[30] Foreign Application Priority Data

May 11, 1987 [WO] World Int. Prop. O. .... 008627  
[52] U.S. Cl. .... D14/150  
[58] Field of Search ..... D14/52, 53, 63, 54, D14/64; 379/440, 419, 428, 433, 434, 436; 455/89, 90

[56] References Cited

U.S. PATENT DOCUMENTS

- D. 236,627 9/1975 Henshaw et al. .... D14/63
- D. 292,703 11/1987 Tragatsching ..... D14/53
- D. 293,102 12/1987 Bullock et al. .... D14/53
- D. 293,572 1/1988 Büchin ..... D14/62 X
- D. 294,249 2/1988 Hyvönen ..... D14/53
- D. 294,695 3/1988 Endt ..... D14/53

- D. 296,439 6/1988 Strahan ..... D14/64
- D. 297,732 9/1988 Chan ..... D14/63 X
- 4,581,490 4/1986 Genender ..... 179/100 R
- 4,647,722 3/1987 Nishida et al. .... 379/63
- 4,736,411 4/1988 Chan ..... 379/428 X

Primary Examiner—Horace B. Fay, Jr.  
Attorney, Agent, or Firm—McGlew & Tuttle

[57] CLAIM

The ornamental design for telephone set, as shown and described.

DESCRIPTION

FIGS. 1 and 2 are respectively left and right side elevational view of a Telephone Set showing my new design in cradled relationship;  
FIGS. 3 and 4 are respectively bottom and top plan views thereof;  
FIGS. 5 and 6 are respectively front and rear elevational views thereof;  
FIG. 7 is a bracket associated front elevational view of the base unit and a rear elevational view of the handset shown spaced apart for clarity of representation; and  
FIG. 8 is a bracket associated front elevational view of the base unit and a left side elevational view of the handset shown spread apart for clarity of representation.

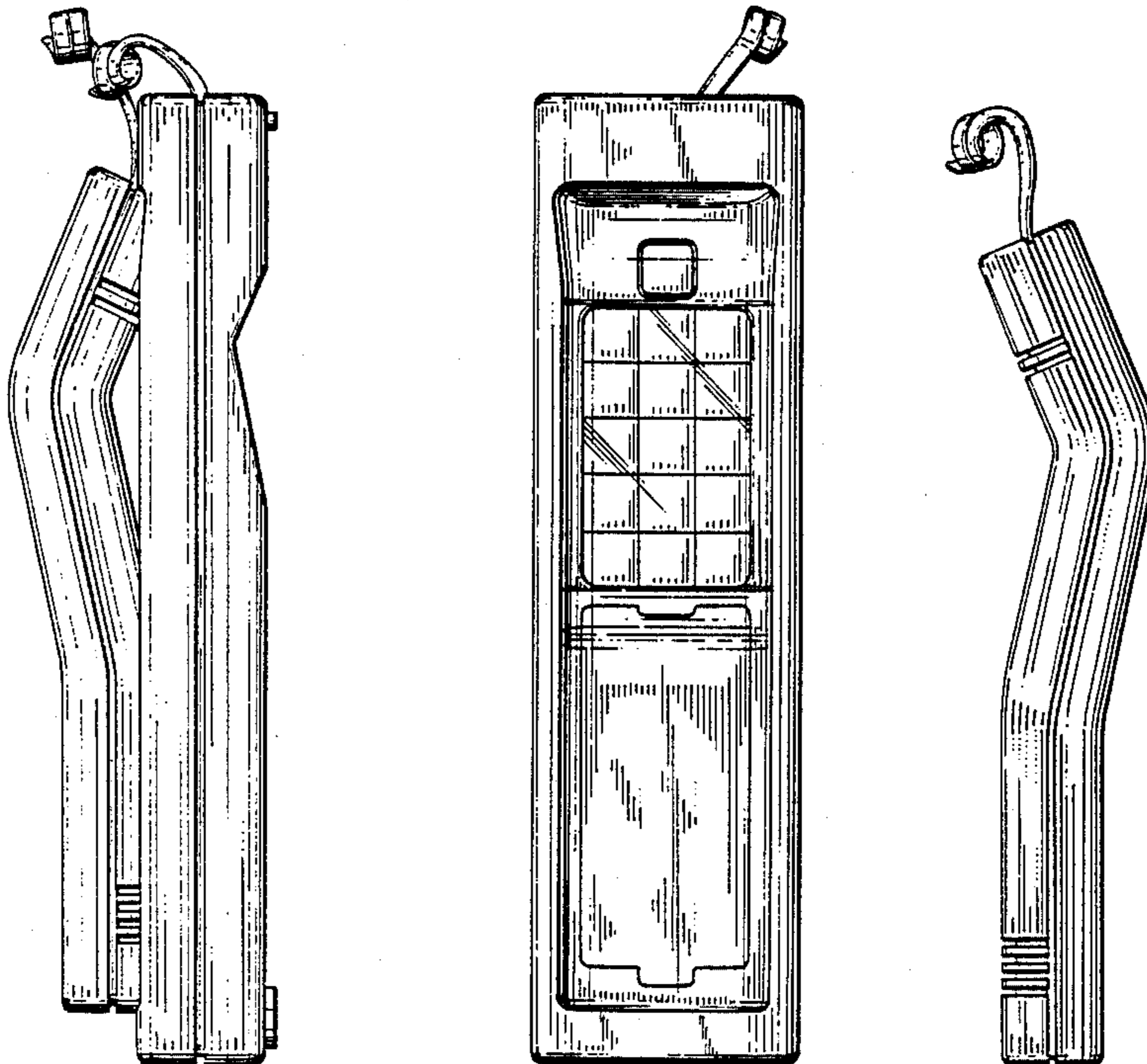

*Fig. 1.*

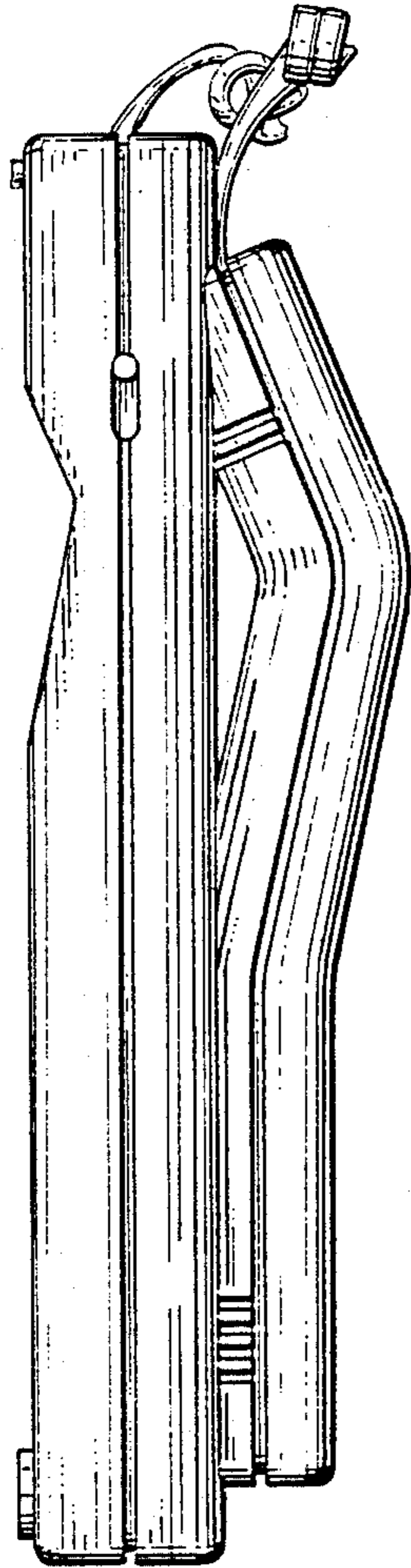

*Fig. 2.*

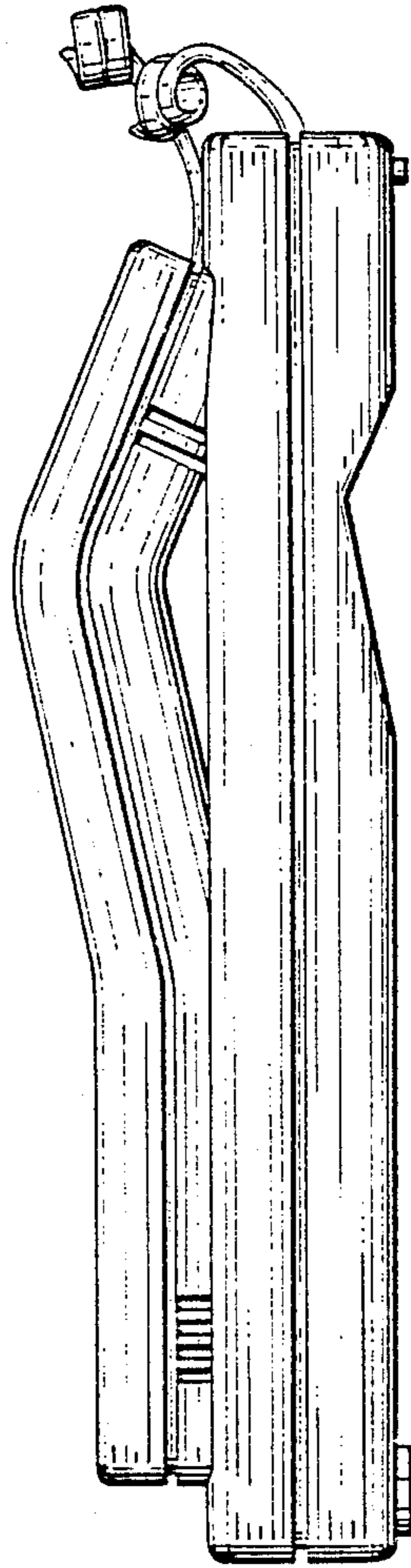

*Fig.3.*

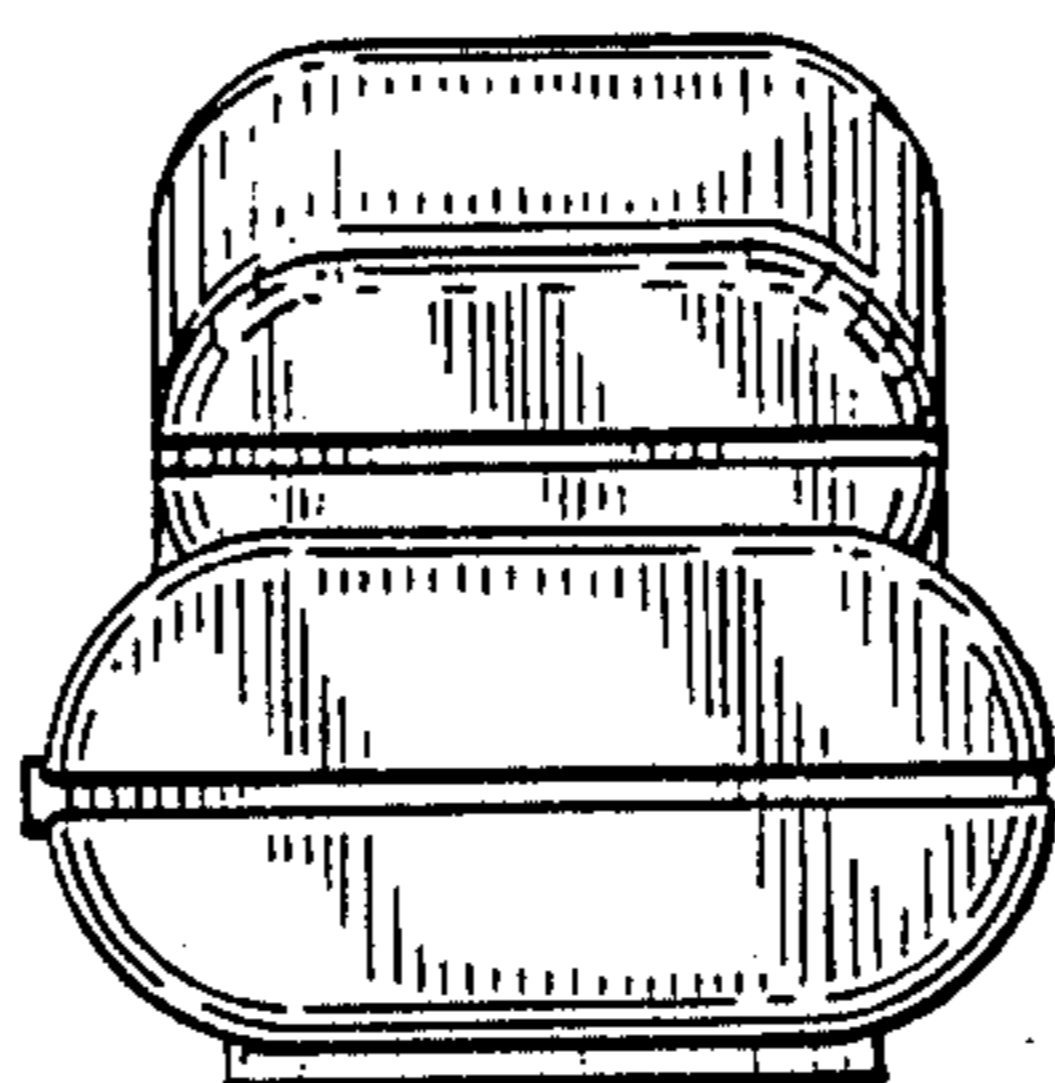

*Fig.4.*

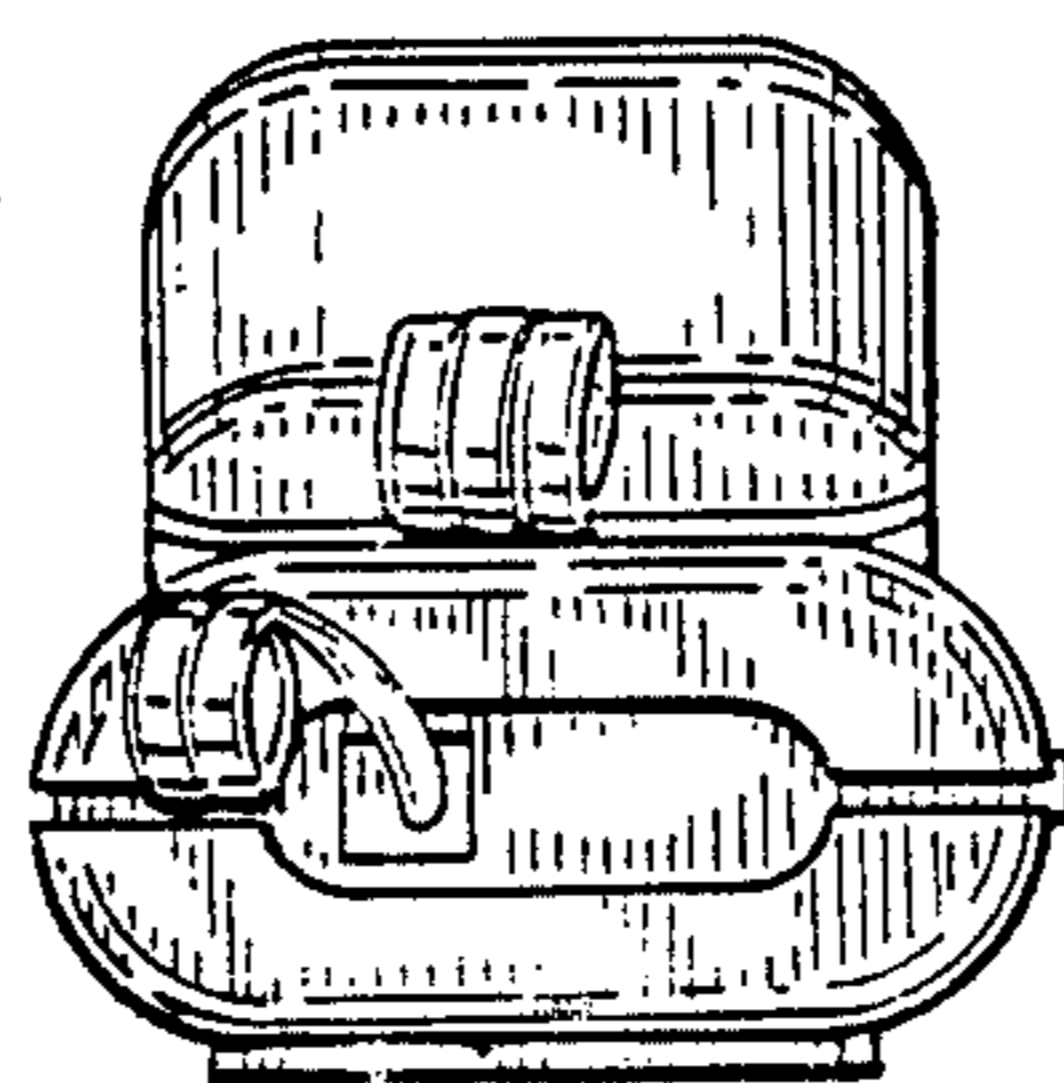

Fig. 5.

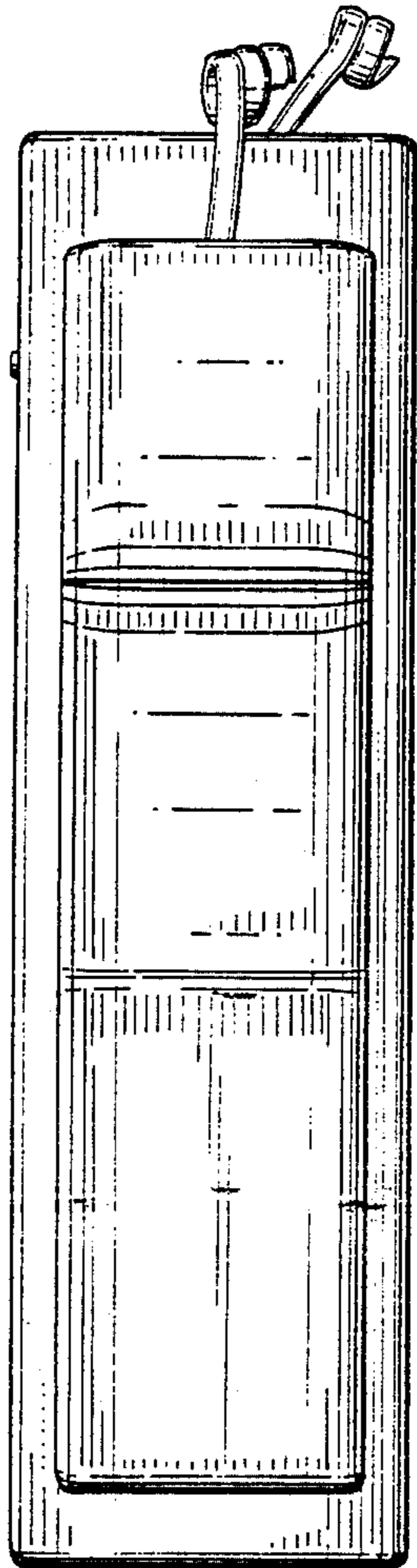

Fig. 6.

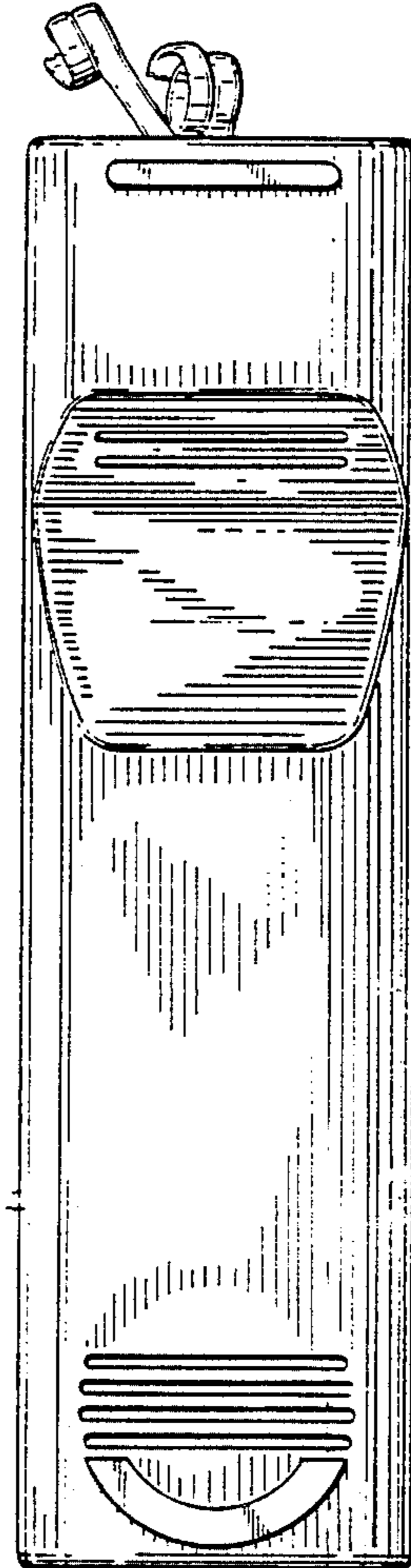

Fig. 7.

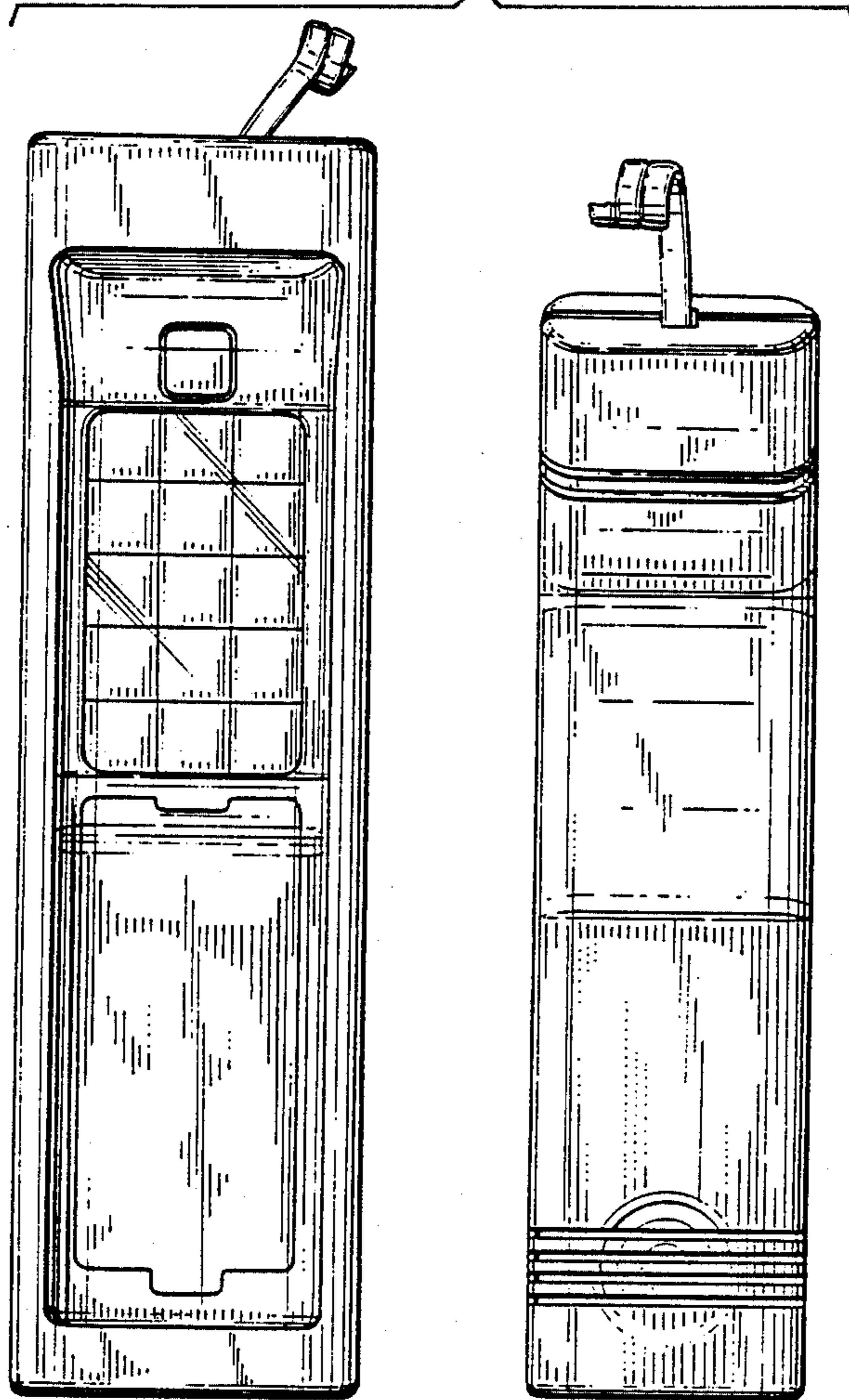

Fig. 8.

