

[54] **POTPOURRI BURNER**

[75] **Inventor: Frank J. Strafella, Powell, Ohio**
[73] **Assignee: The Love Mug, Inc., Worthington, Ohio**
[**] **Term: 14 Years**
[21] **Appl. No.: 61,179**
[22] **Filed: Jun. 12, 1987**
[52] **U.S. Cl. D11/131.1**
[58] **Field of Search D11/131.1; 422/125, 422/126; D26/37, 38, 40, 41, 49**

[56] **References Cited**

U.S. PATENT DOCUMENTS

D. 1,549	3/1862	Miller	D26/41
D. 13,394	11/1882	Ewing	D26/41
174,213	2/1876	Dunn	422/126
D. 214,684	7/1969	Roche	D26/41
D. 288,842	3/1987	Kwiatkowski	D11/131.1
791,930	6/1905	Mullen	422/126
1,036,759	8/1912	White	422/126
1,817,057	8/1931	Berry	422/125
1,824,055	9/1931	Newton	422/126
1,948,625	2/1934	Sykes	422/126 X
3,058,178	10/1962	Campagna	422/126

FOREIGN PATENT DOCUMENTS

3768 of 1899 United Kingdom 422/125

OTHER PUBLICATIONS

Gifts & Decorative Accessories, 5/86, p. 45—Potpourri Burners at top.
Gifts & Decorative Accessories, 5/86, p. 103—Potpourri Warmer at bottom right.
Gifts & Decorative Accessories, 10/86, p. 73—Country Kettle & Home Scents Fragrance Warmers at right.
Gifts & Decorative Accessories, 10/86, p. 144—Potpourri Warmers at bottom.

Primary Examiner—Louis S. Zarfes
Attorney, Agent, or Firm—Frank H. Foster

[57] **CLAIM**

The ornamental design for a potpourri burner, as shown.

DESCRIPTION

FIG. 1 is a front elevational view of a potpourri burner showing my new design.
FIG. 2 is a rear elevational view thereof.
FIG. 3 is a right side elevational view thereof.
FIG. 4 is a left side elevational view thereof.
FIG. 5 is a top plan view thereof.
FIG. 6 is a bottom plan view thereof.
FIG. 7 is a front perspective view thereof.

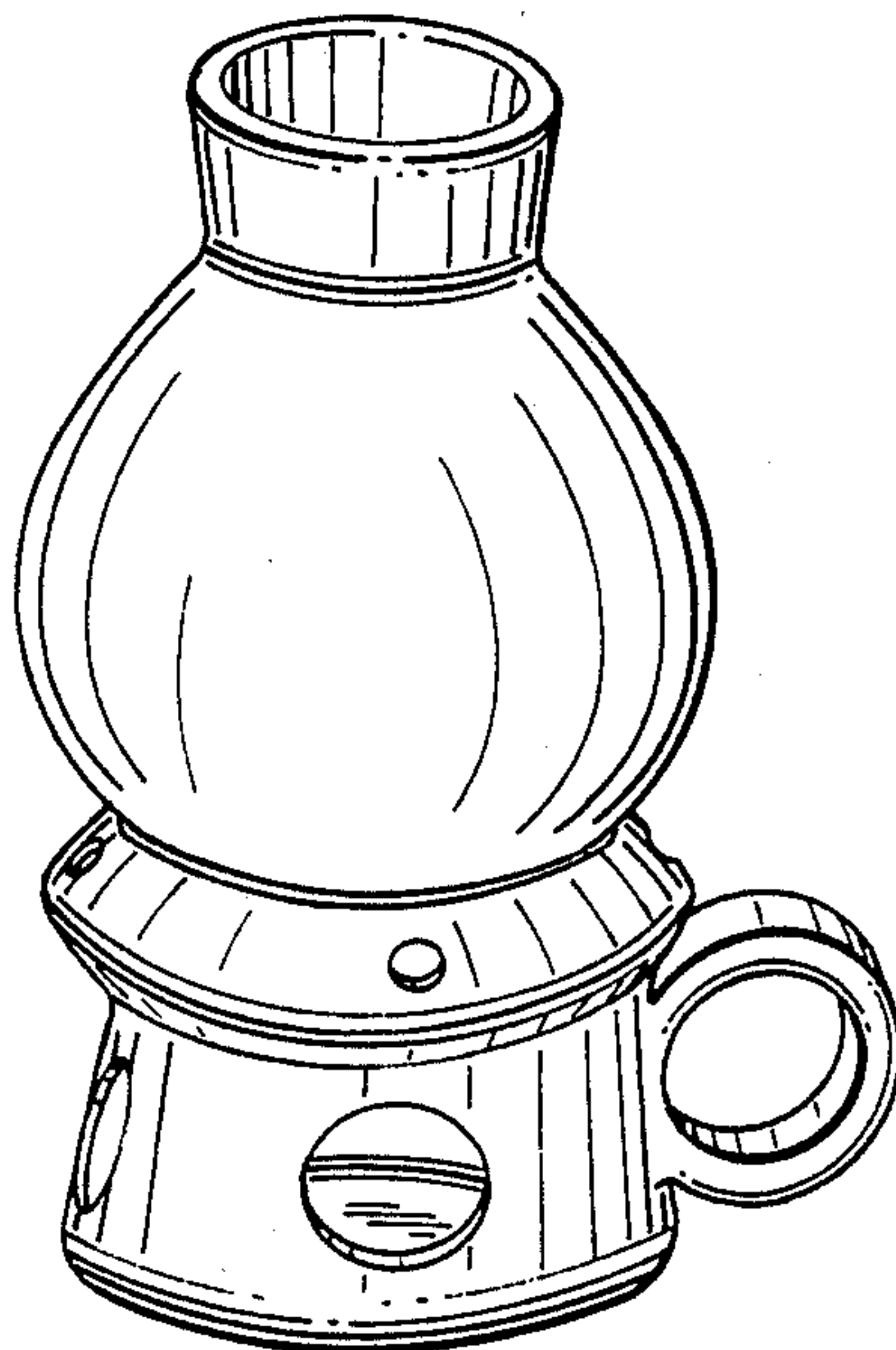

FIG. 1

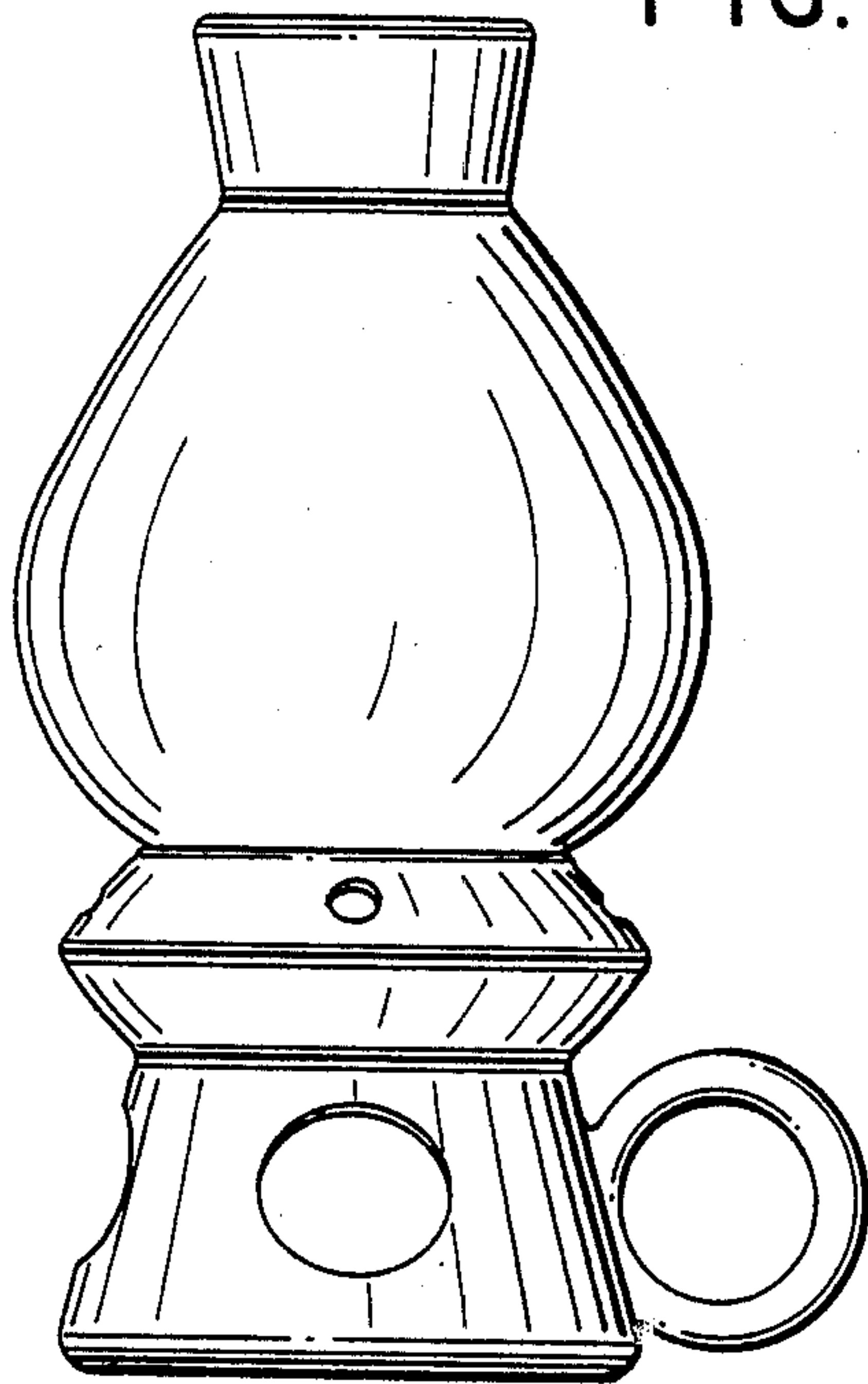

FIG. 2

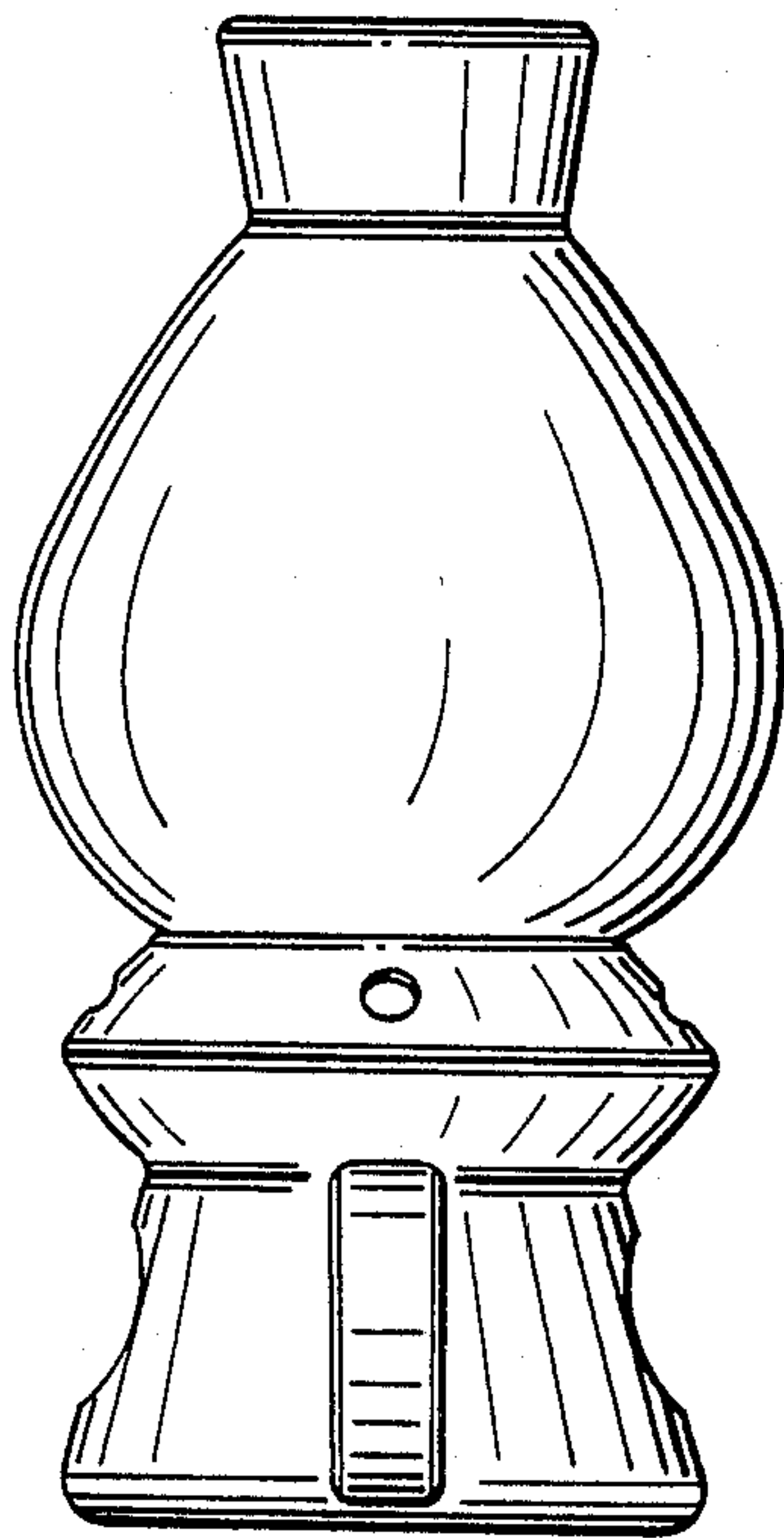
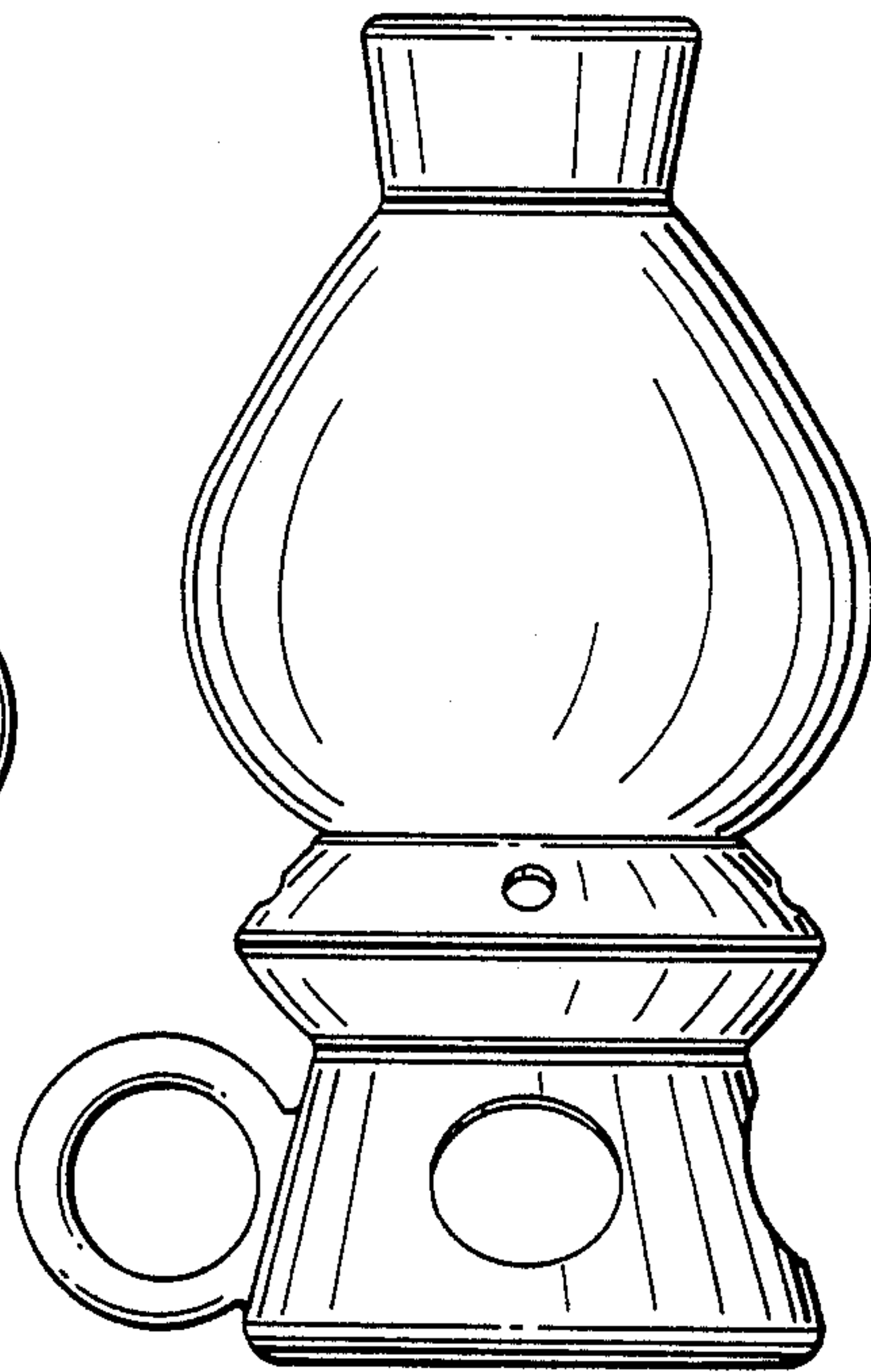

FIG. 3

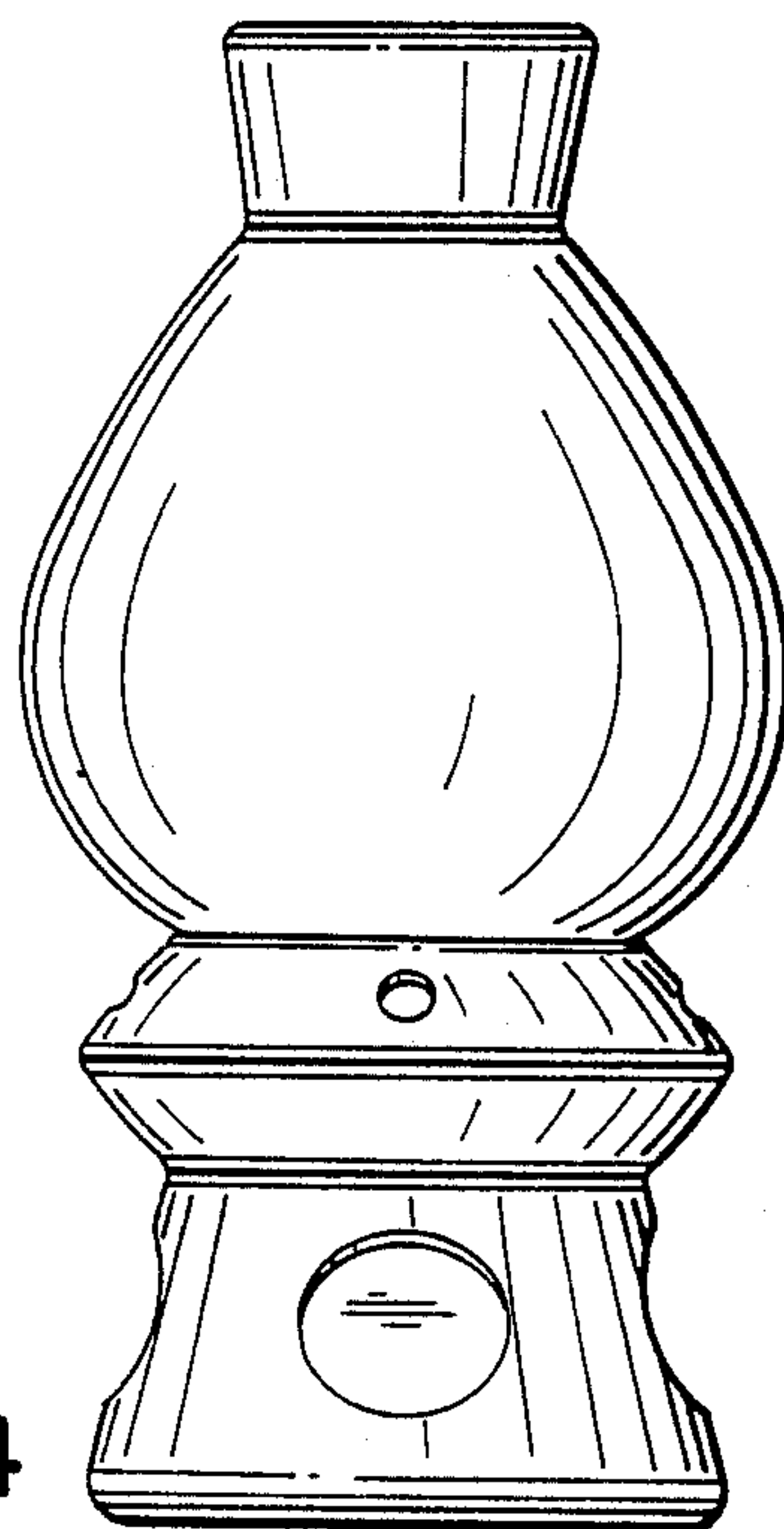

FIG. 4

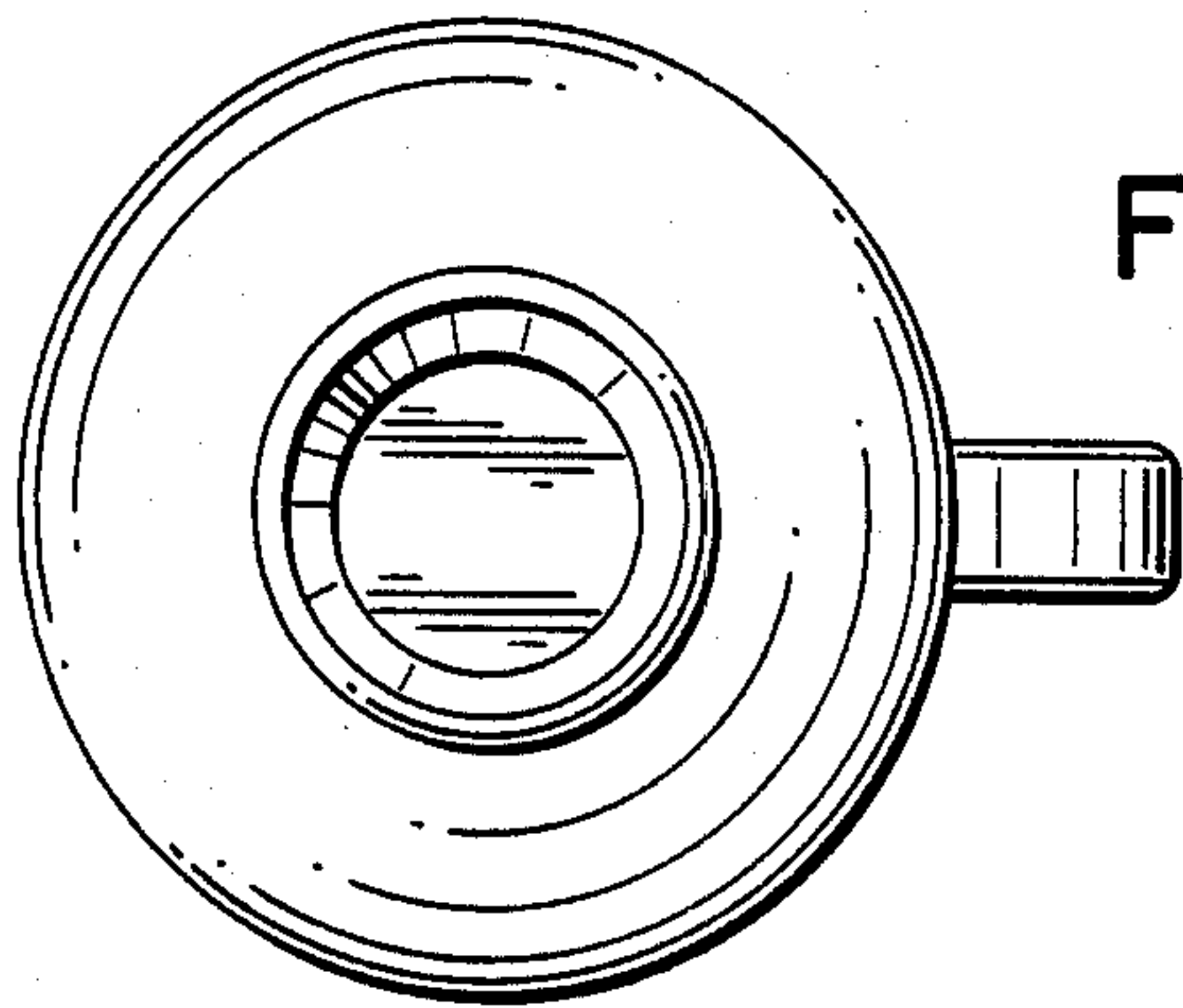

FIG. 5

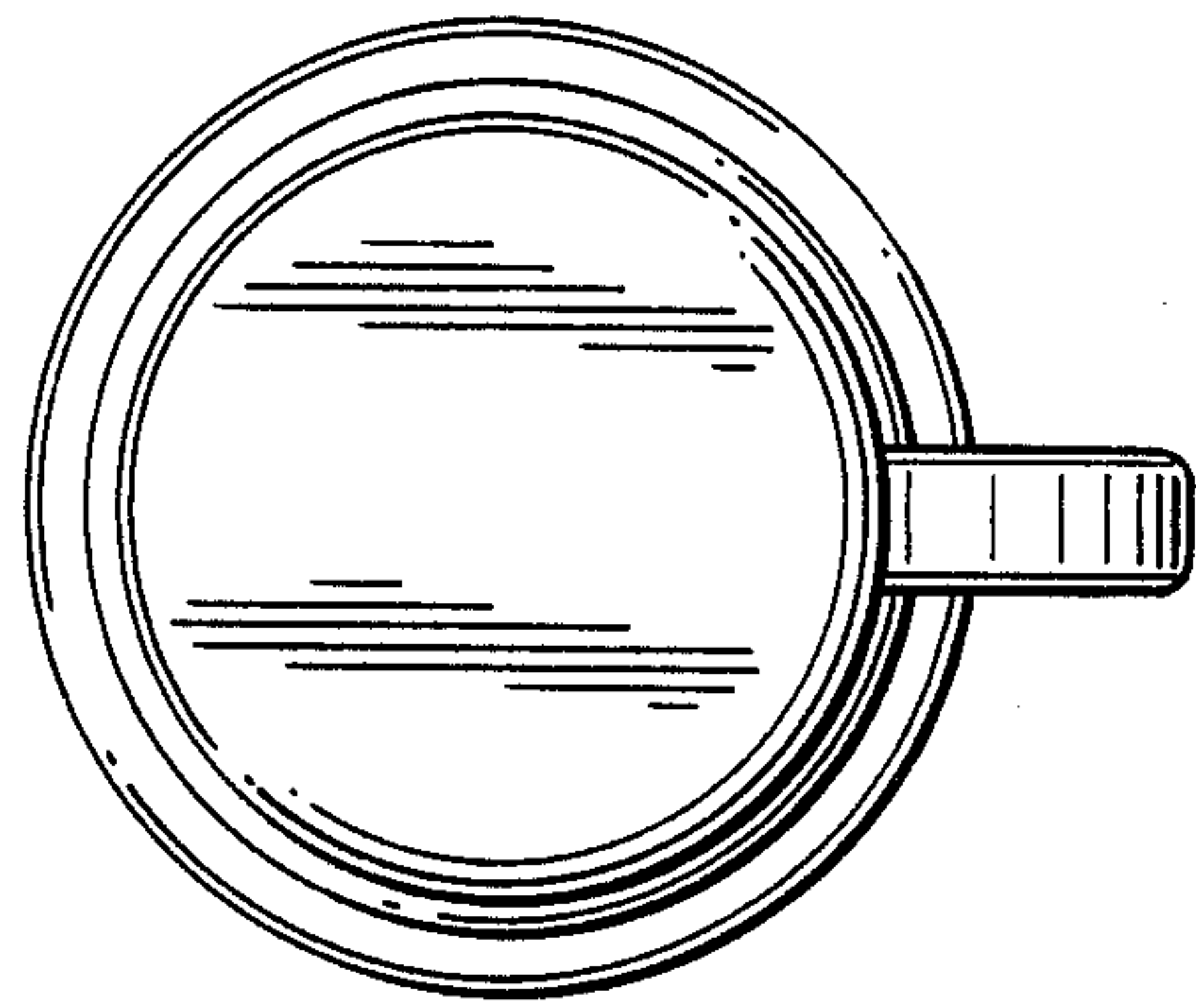

FIG. 6

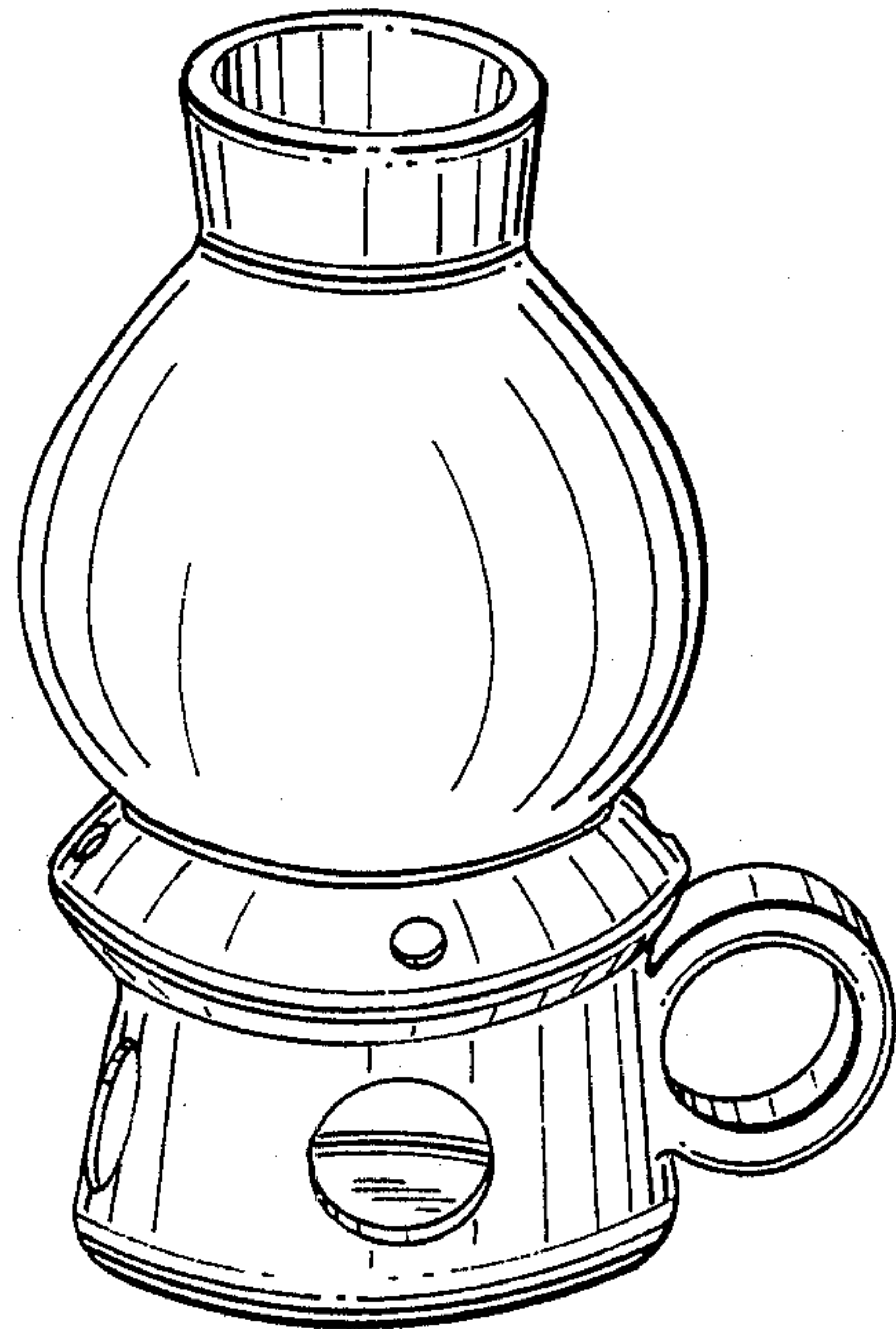

FIG. 7