

[54] **TACO HOLDER**

[76] **Inventor:** Mark W. Walmesley, 37 Eastshore, Irvine, Calif. 92714
 [**] **Term:** 14 Years
 [21] **Appl. No.:** 856,138
 [22] **Filed:** Apr. 21, 1986
 [52] **U.S. Cl.** D7/76; D7/38
 [58] **Field of Search** D7/70, 71, 37-38, D7/411, 76; D9/455, 341; 99/426; 220/23.8; 206/562-564; 211/71, 13

[56] **References Cited**

U.S. PATENT DOCUMENTS

D. 275,256 8/1984 Gilliam D7/76
 D. 291,269 8/1987 Richards D7/76
 2,175,753 10/1939 Guthmann 211/13

Primary Examiner—Bernard Ansher
Assistant Examiner—Terry Pfeffer
Attorney, Agent, or Firm—Leonard Tachner

[57] **CLAIM**

The ornamental design for a taco holder, as shown and described.

DESCRIPTION

FIG. 1 is a perspective view of a taco holder showing my new design;
 FIG. 2 is a perspective view thereof of a second embodiment of that shown in FIG. 1;
 FIG. 3 is a perspective view of a third embodiment of that shown in FIG. 1;
 FIG. 4 is a right side elevational view thereof;
 FIG. 5 is a front elevational view thereof;
 FIG. 6 is a rear elevational view thereof;
 FIG. 7 is a top plan view thereof;
 FIG. 8 is a bottom plan view thereof;
 FIG. 9 is a right side elevational view of that shown in FIG. 2;
 FIG. 10 is a front elevational view of that shown in FIG. 2;
 FIG. 11 is a rear elevational view of that shown in FIG. 2;
 FIG. 12 is a top plan view of that shown in FIG. 2;
 FIG. 13 is a bottom plan view of that shown in FIG. 2;
 FIG. 14 is a right side elevational view of that shown in FIG. 3;
 FIG. 15 is a front elevational view of that shown in FIG. 3;
 FIG. 16 is a rear elevational view of that shown in FIG. 3;
 FIG. 17 is a top plan view of that shown in FIG. 3; and,
 FIG. 18 is a bottom plan view of that shown in FIG. 3.

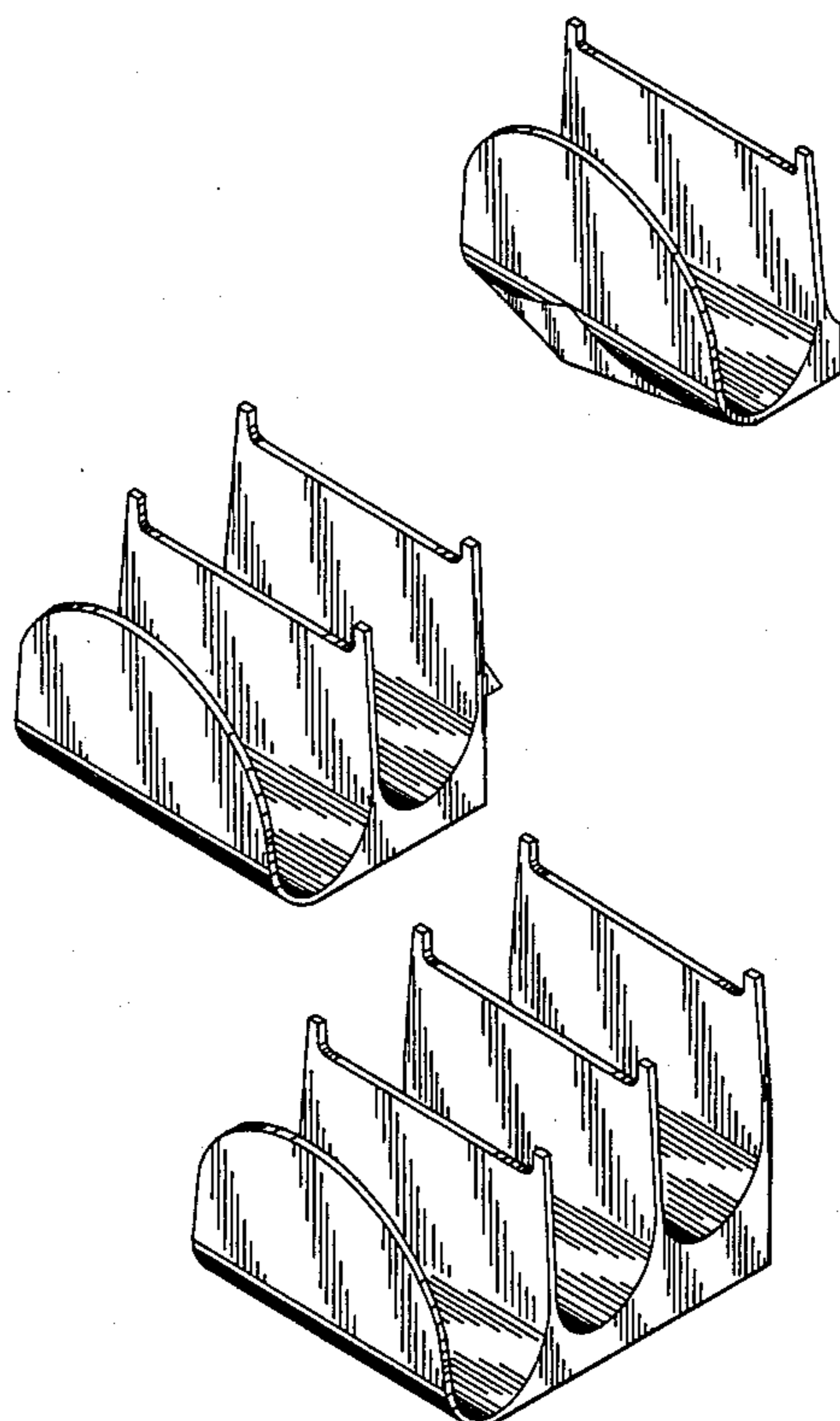

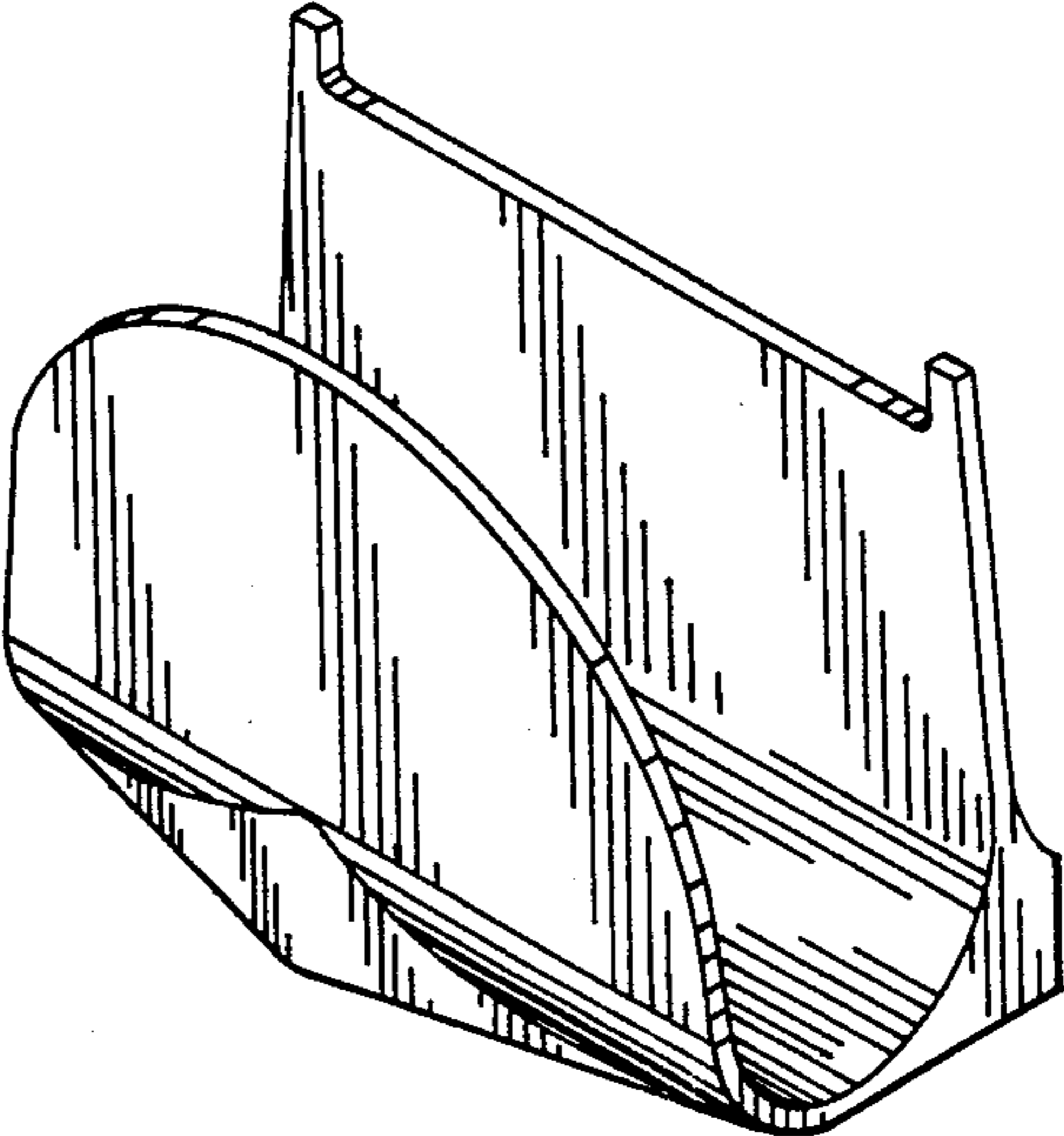

FIG. 1

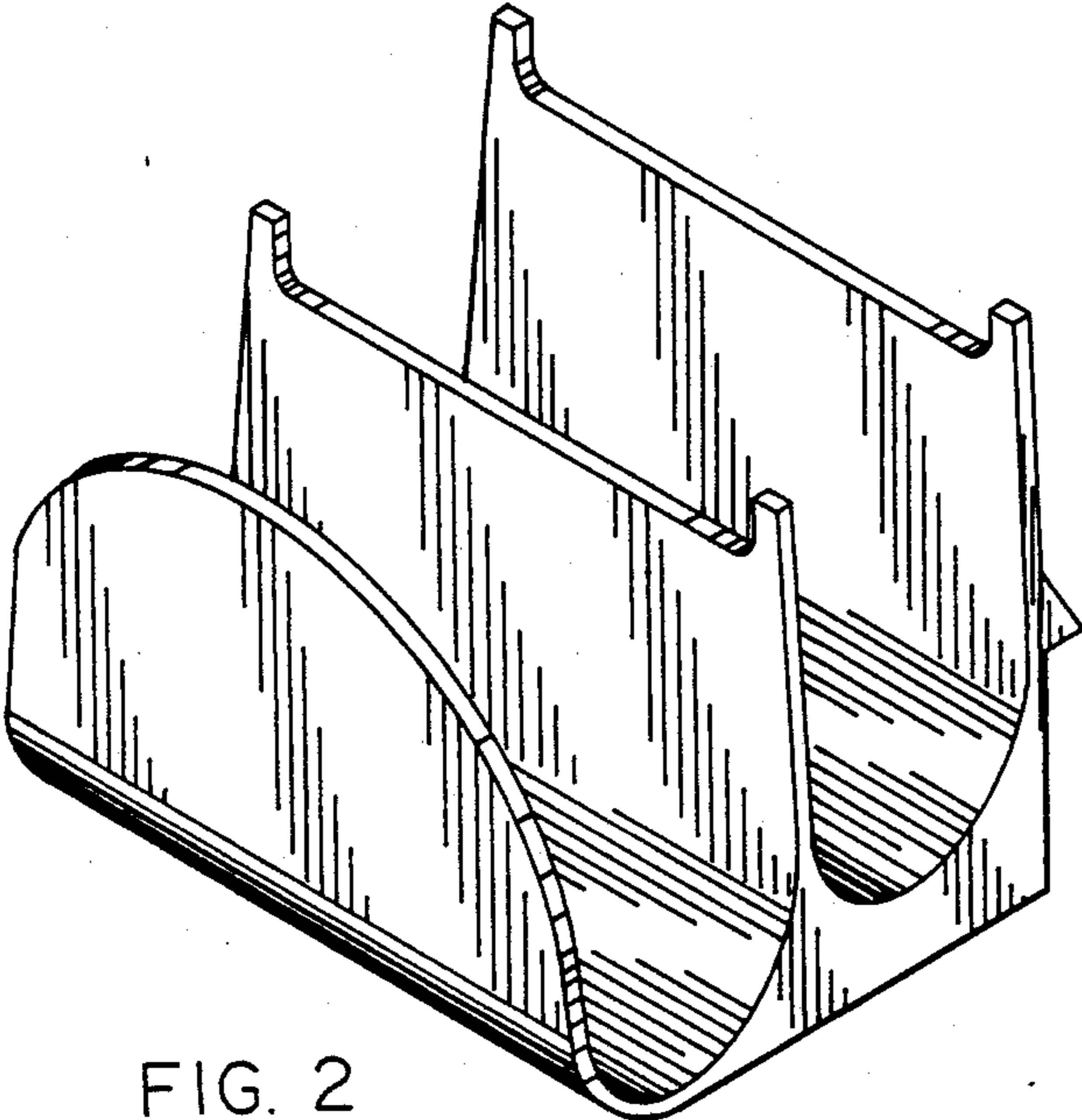

FIG. 2

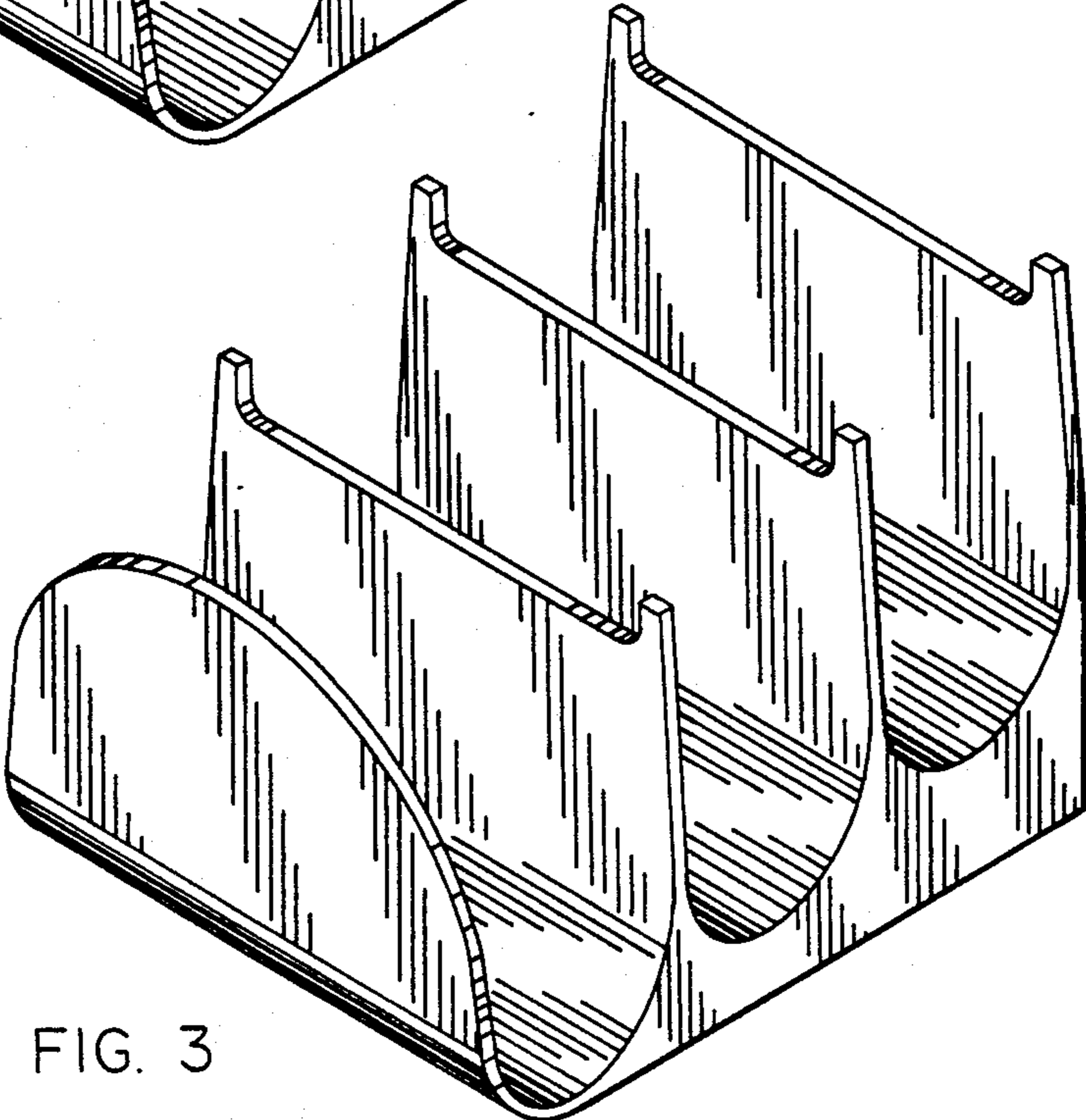

FIG. 3

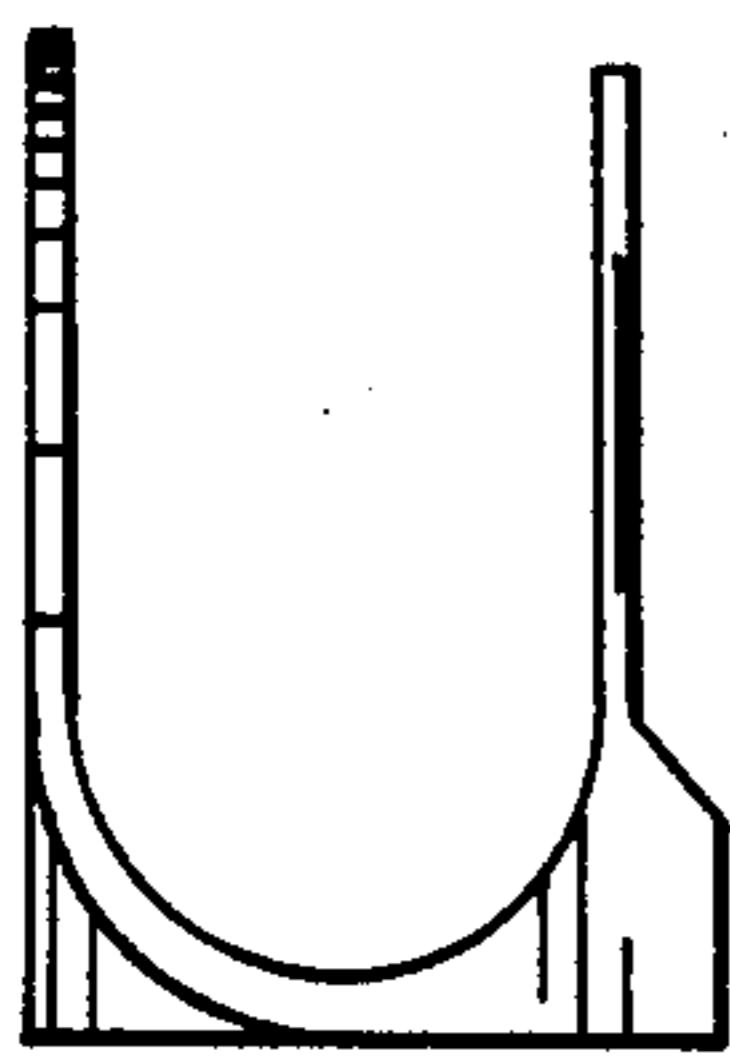

FIG. 4

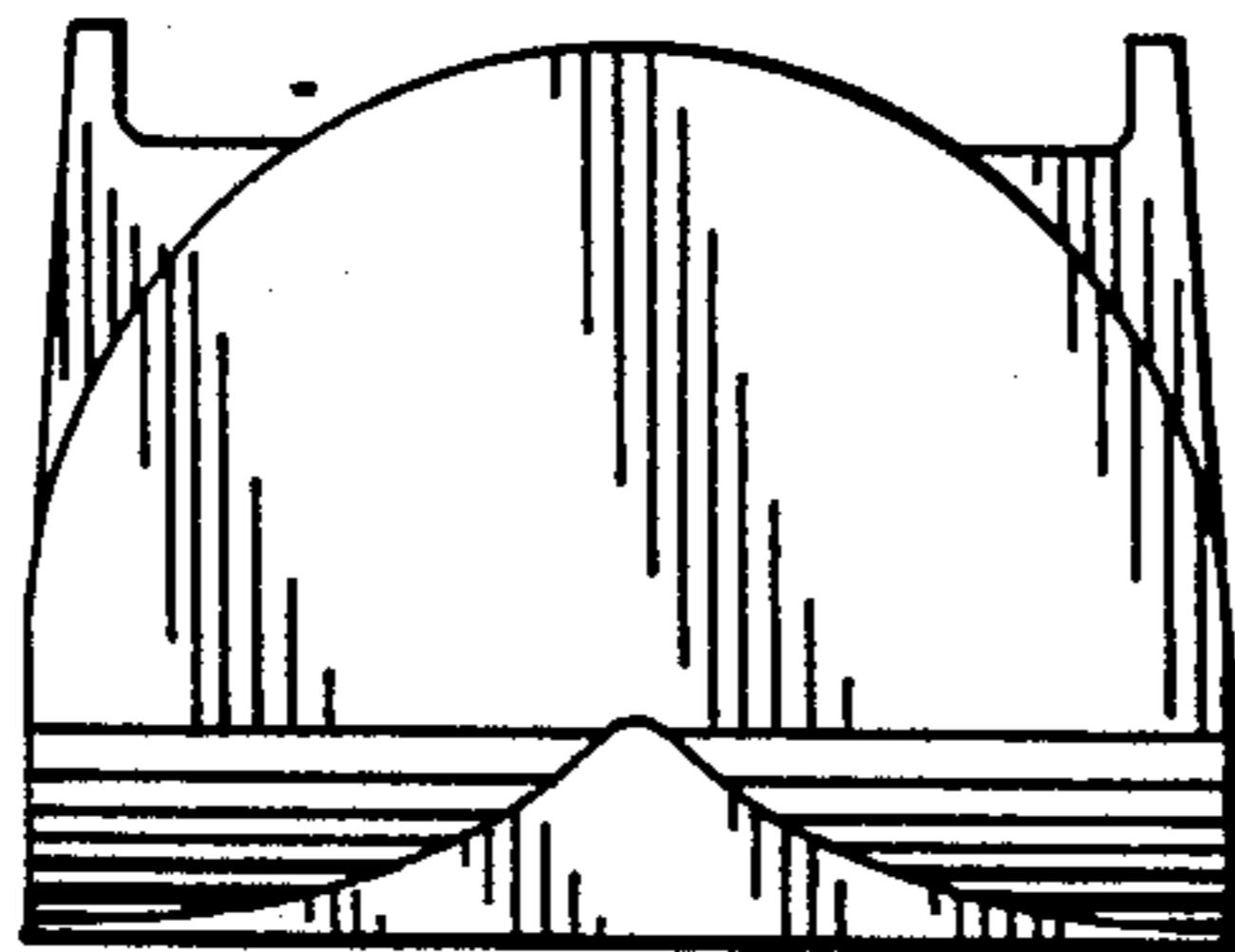

FIG. 5

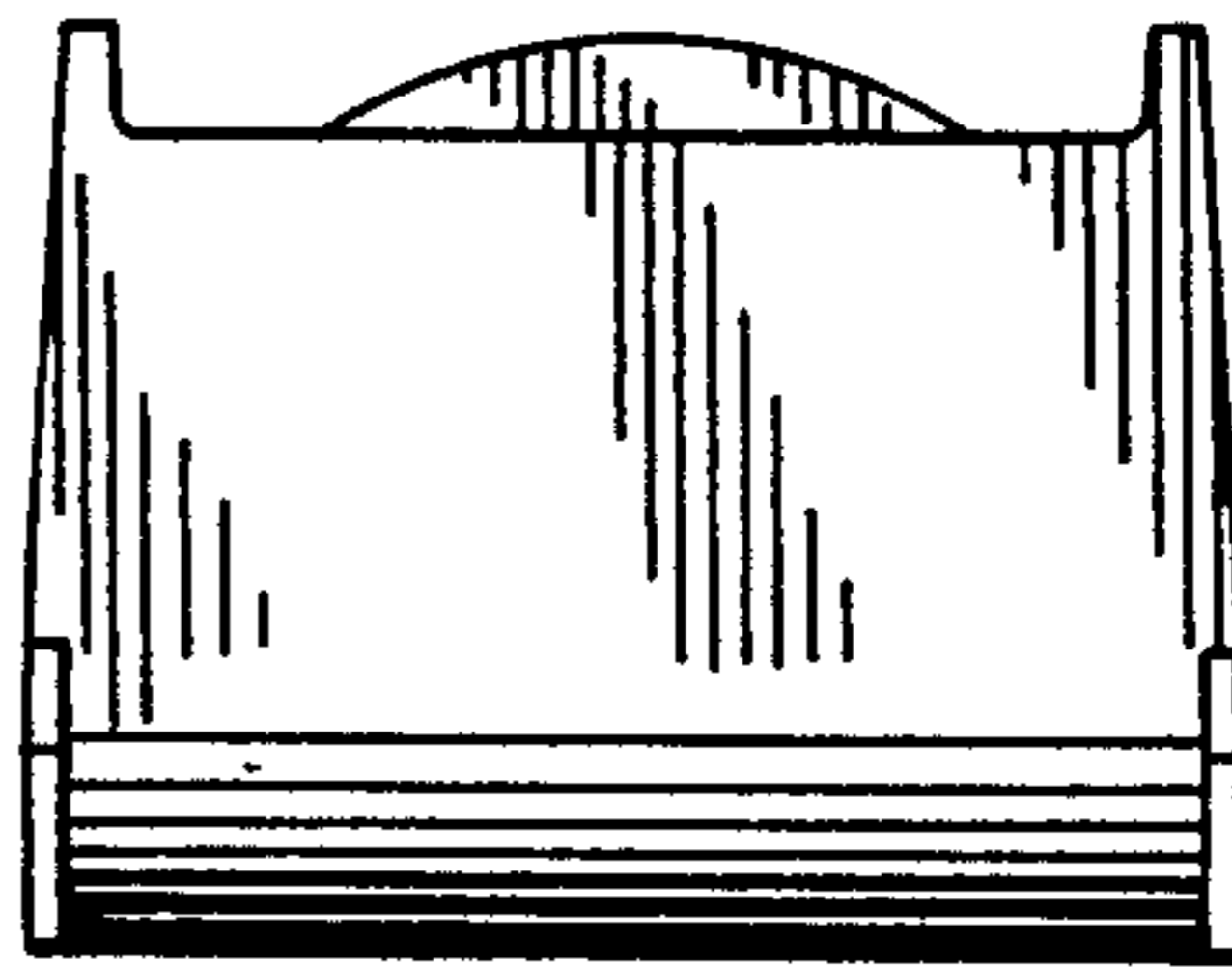

FIG. 6

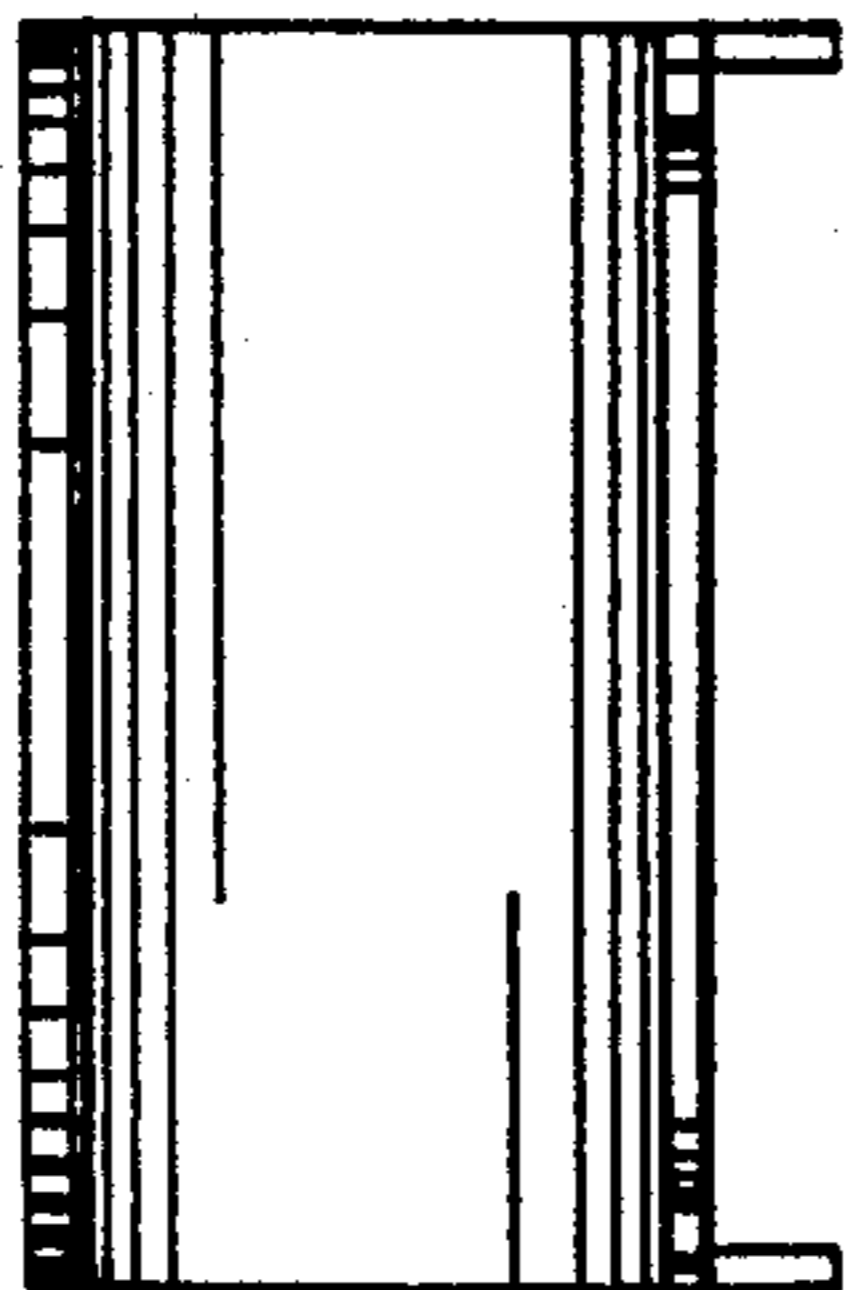

FIG. 7



FIG. 8

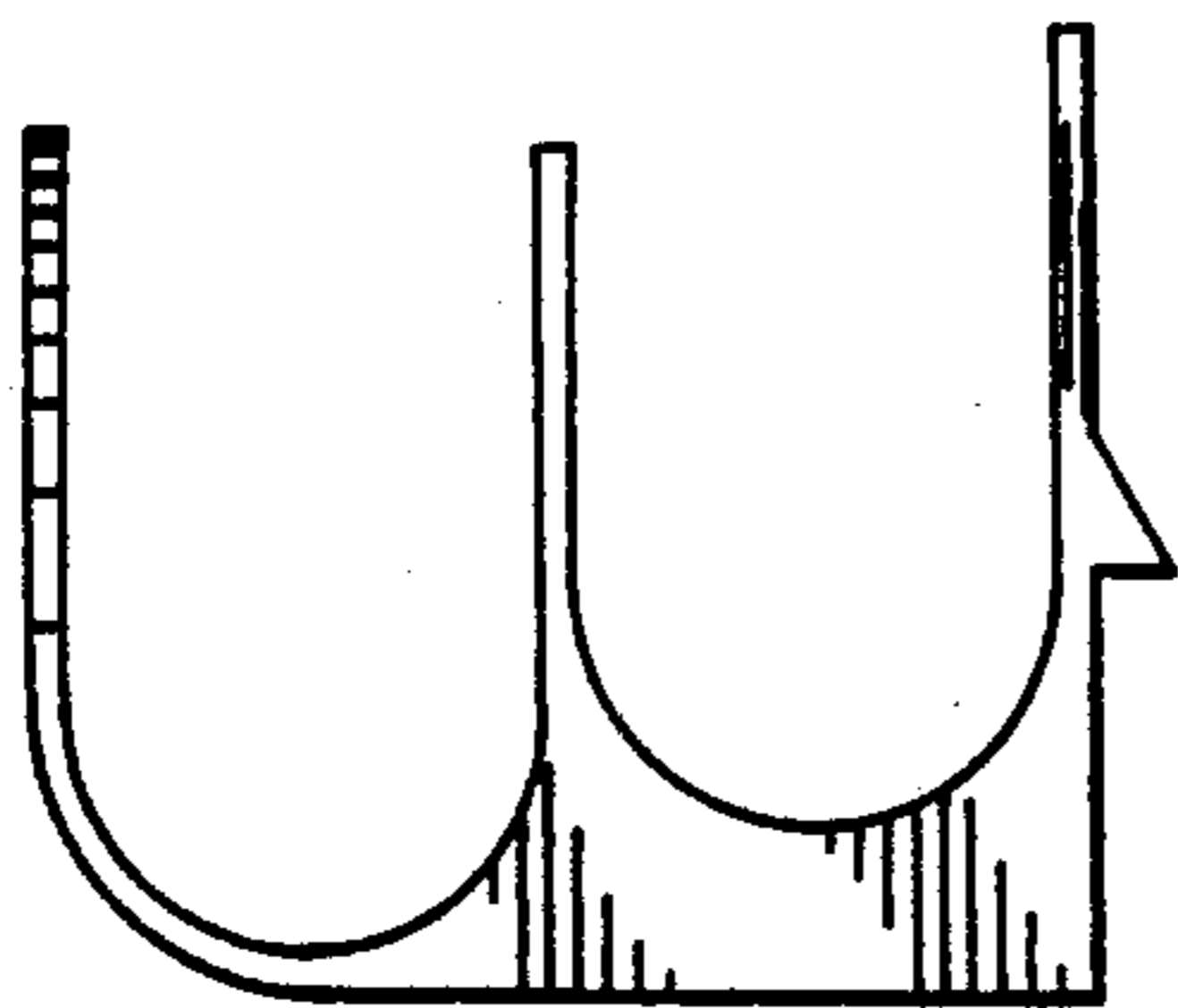

FIG. 9

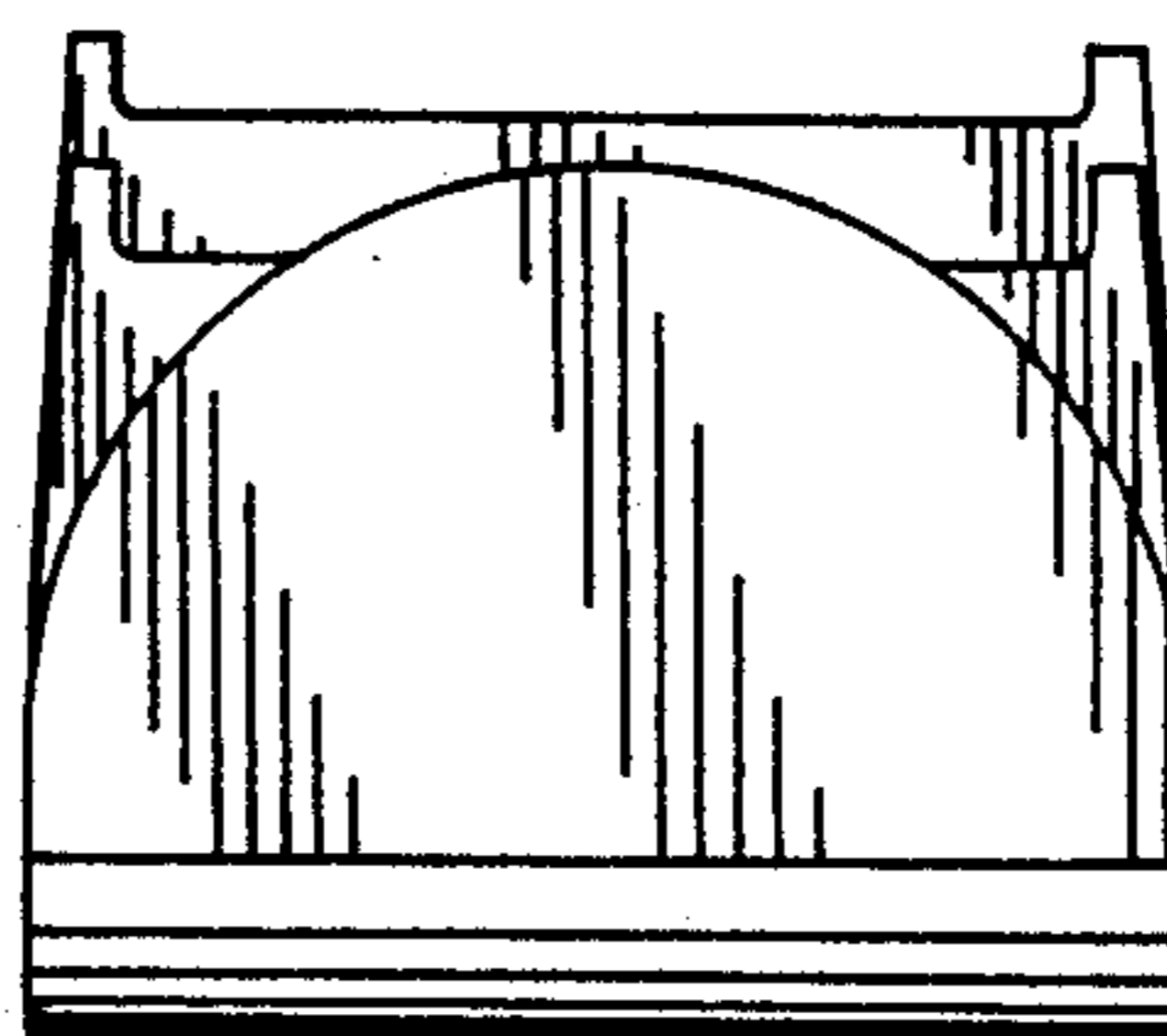

FIG. 10

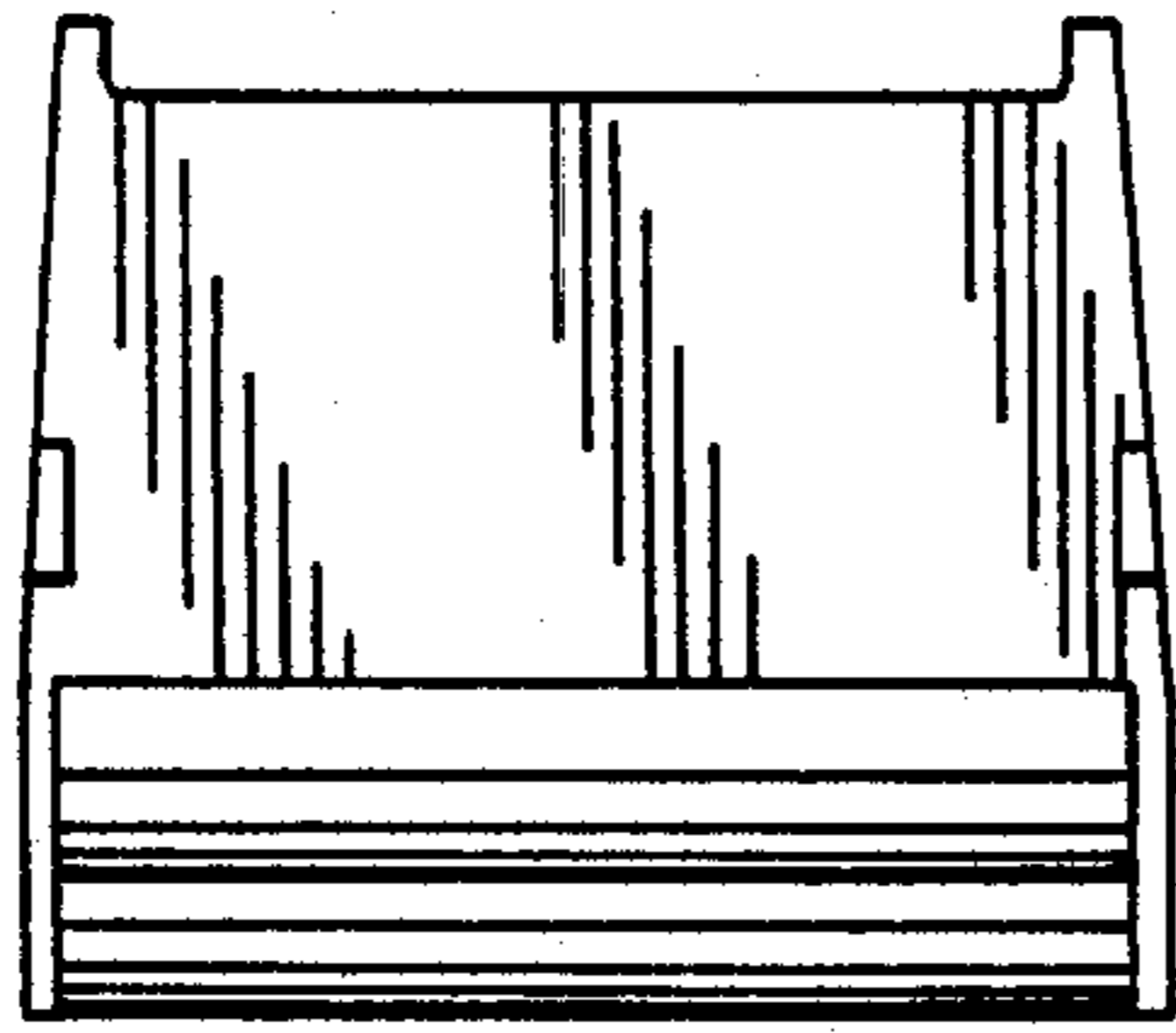

FIG. 11

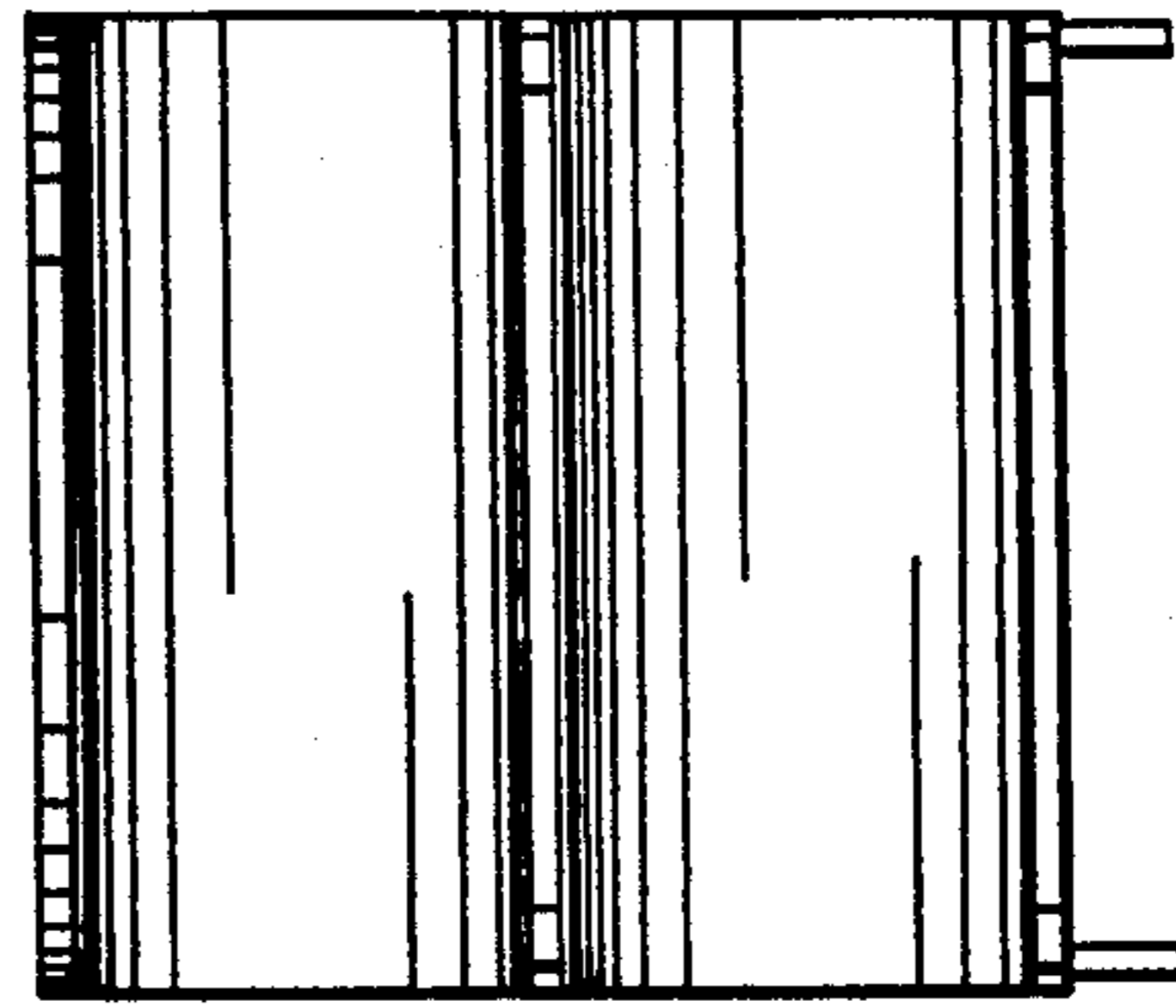

FIG. 12

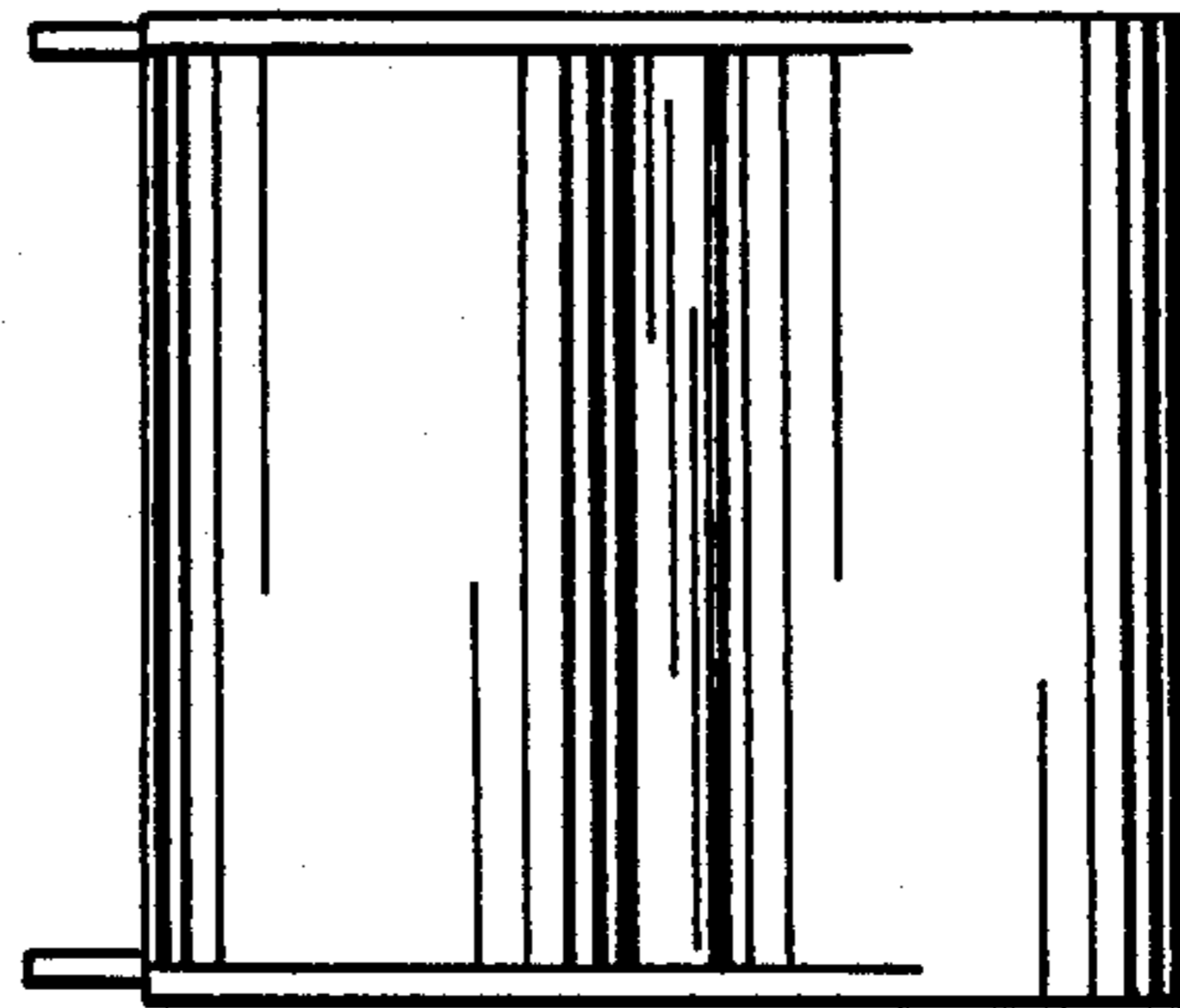

FIG. 13

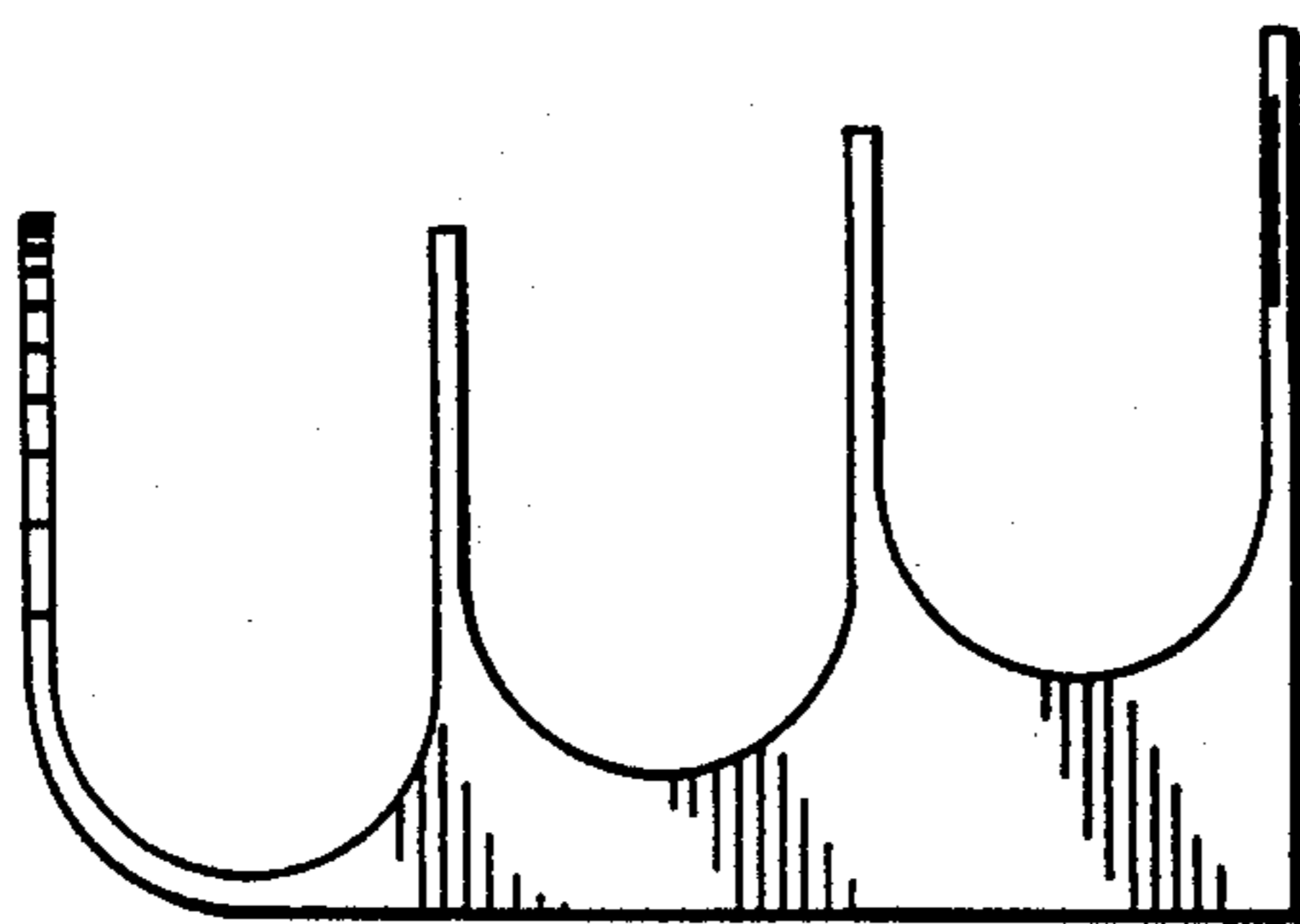

FIG. 14

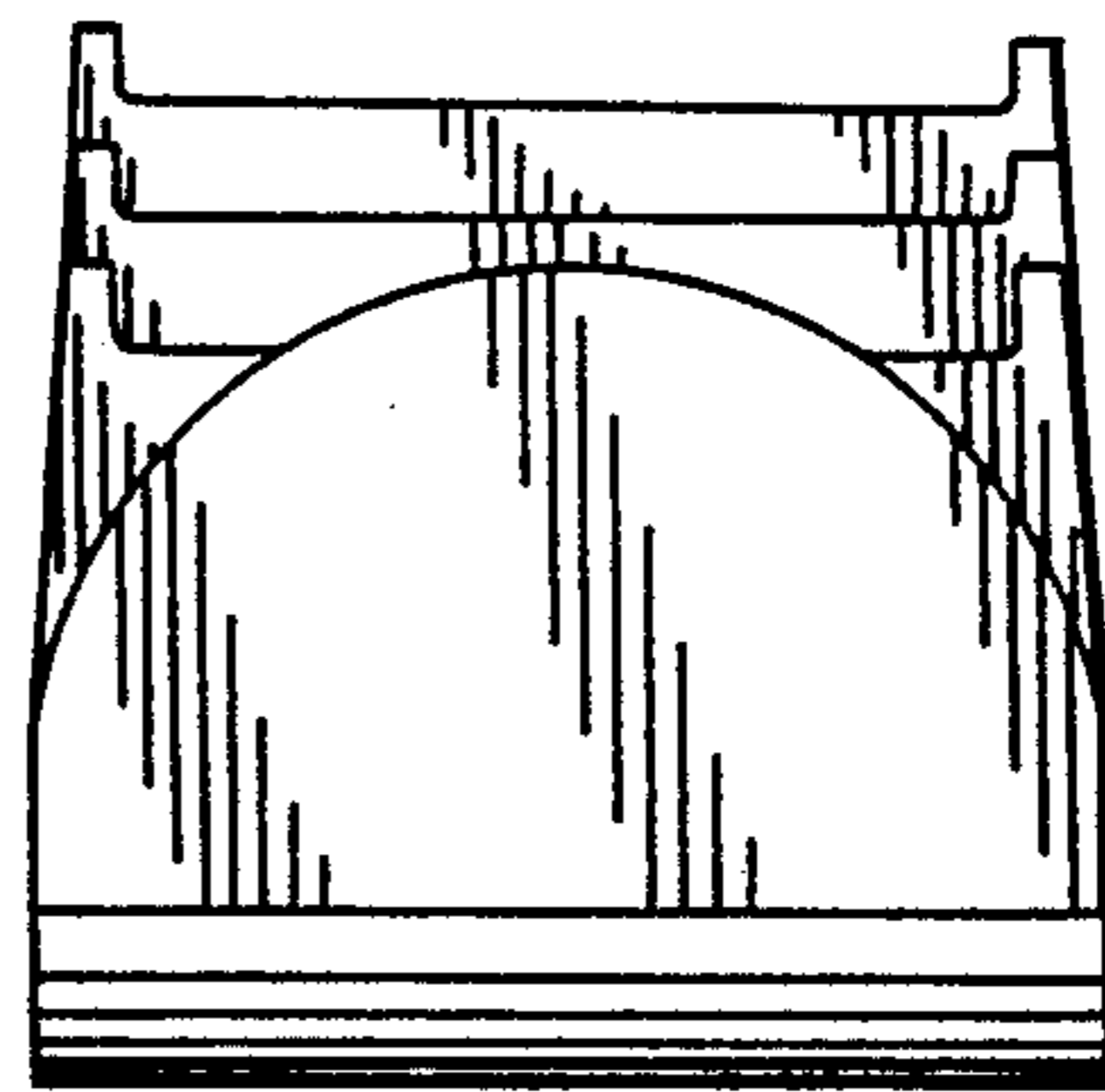

FIG. 15

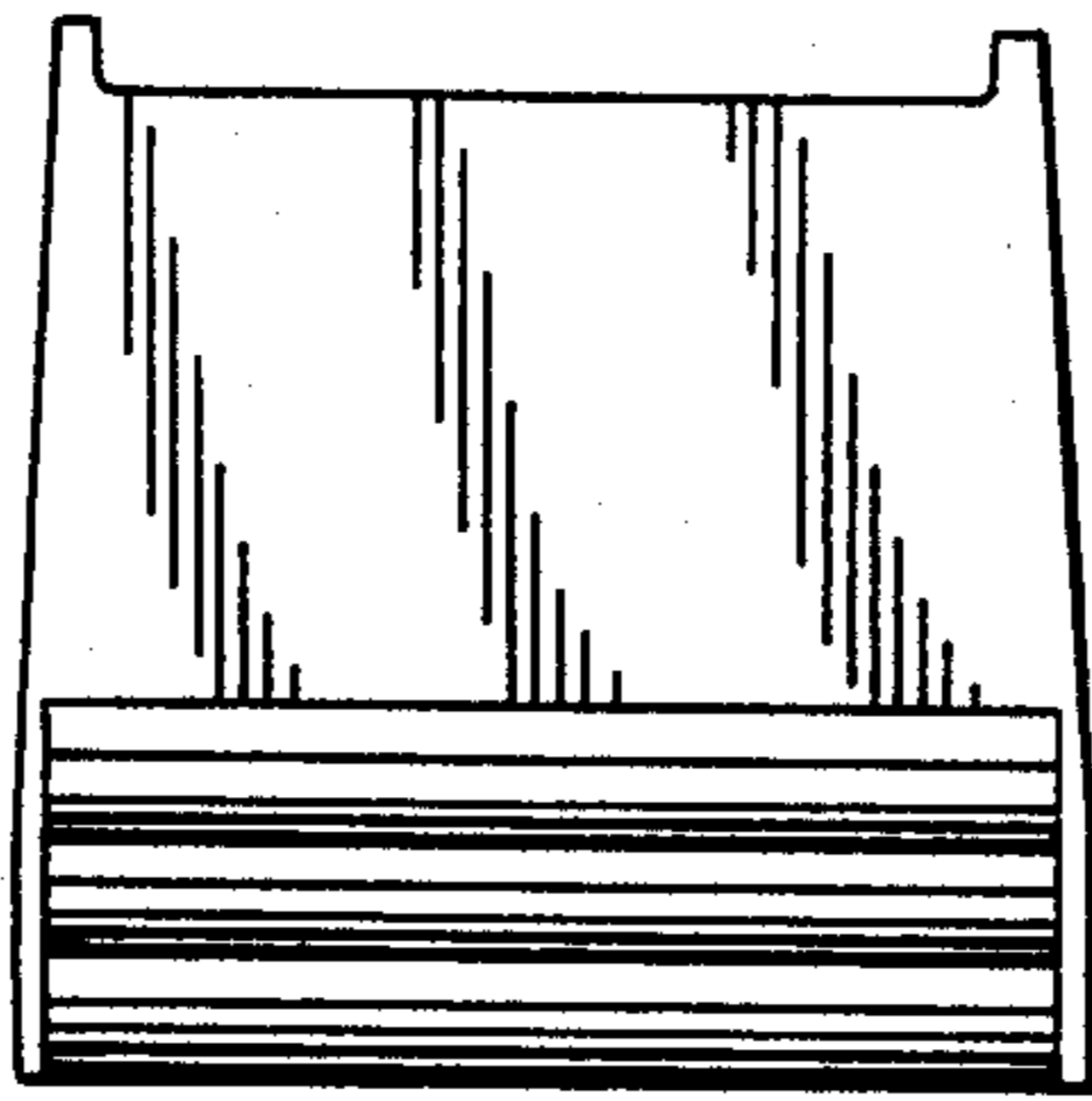

FIG. 16

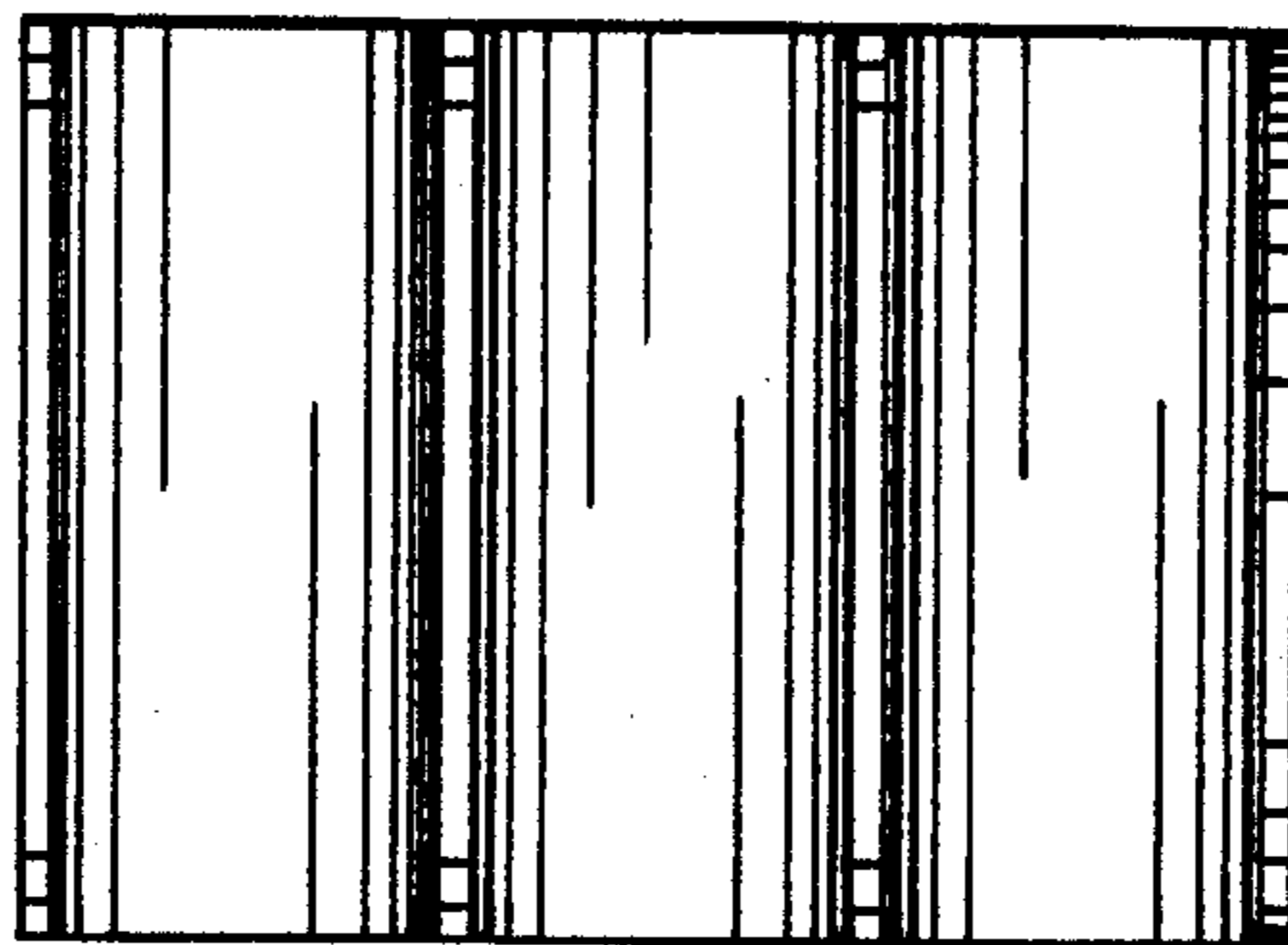

FIG. 17

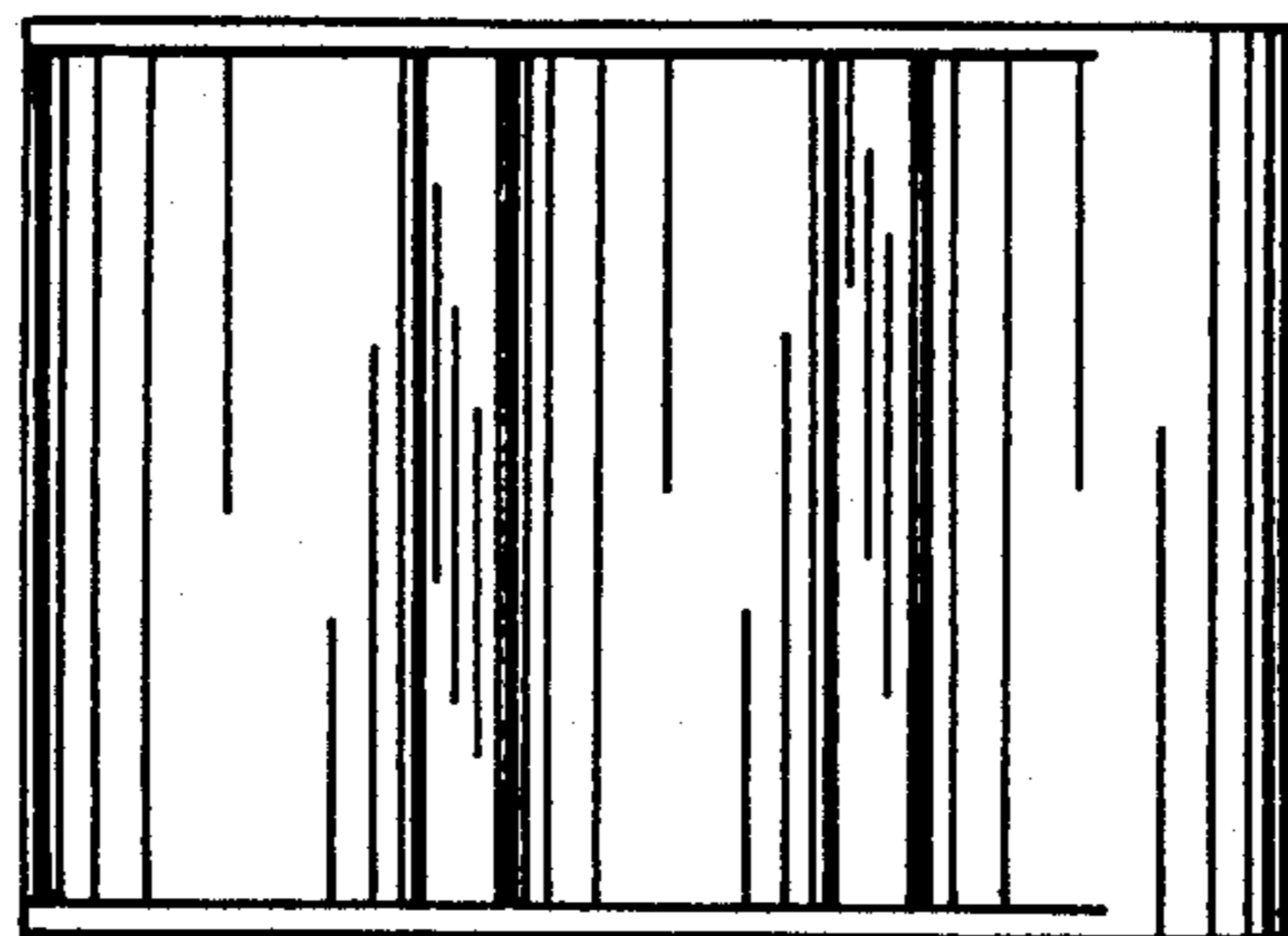

FIG. 18