

[54] PORTABLE LIGHT

[75] Inventor: Keiichi Ohashi, Shizuoka, Japan

[73] Assignee: Skylite Industry Co. Ltd., Shizuoka, Japan

[*] Notice: The portion of the term of this patent subsequent to Apr. 11, 2003 has been disclaimed.

[**] Term: 14 Years

[21] Appl. No.: 731,407

[22] Filed: May 7, 1985

[52] U.S. Cl. D26/49

[58] Field of Search D26/37-50;
362/157, 158, 183-191, 194-205

[56] References Cited

U.S. PATENT DOCUMENTS

D. 183,698 10/1958 Lewis D26/49

D. 238,604 1/1976 Brindley D26/49
D. 241,971 10/1976 Brindley D26/49
D. 268,528 4/1983 Hung D26/49
D. 287,642 1/1987 Chi-Hung D26/46 X
2,942,102 6/1960 Stoutenburgh 362/157
3,710,092 1/1973 Olbermann, Jr. D26/49 X

Primary Examiner—Susan J. Lucas
Attorney, Agent, or Firm—Wegner & Bretschneider

[57] CLAIM

The ornamental design for portable light, as shown.

DESCRIPTION

FIG. 1 is a perspective view of portable light embodying my new design;
FIG. 2 is a front elevational view thereof;
FIG. 3 is a top plan view thereof;
FIG. 4 is a rear elevational view thereof;
FIG. 5 is a bottom plan view thereof;
FIG. 6 is a right side elevational view thereof; and
FIG. 7 is a left side elevational view thereof.

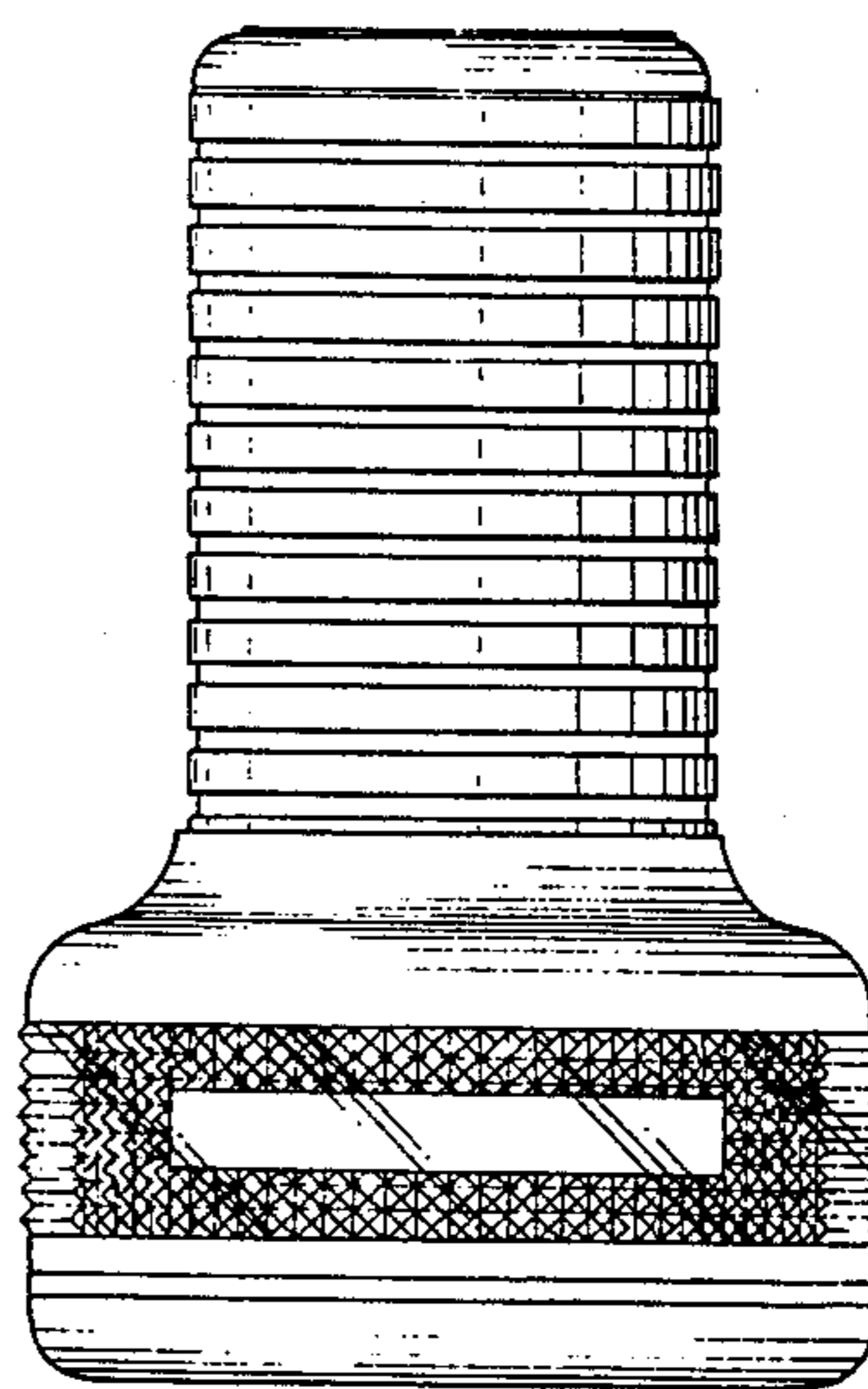
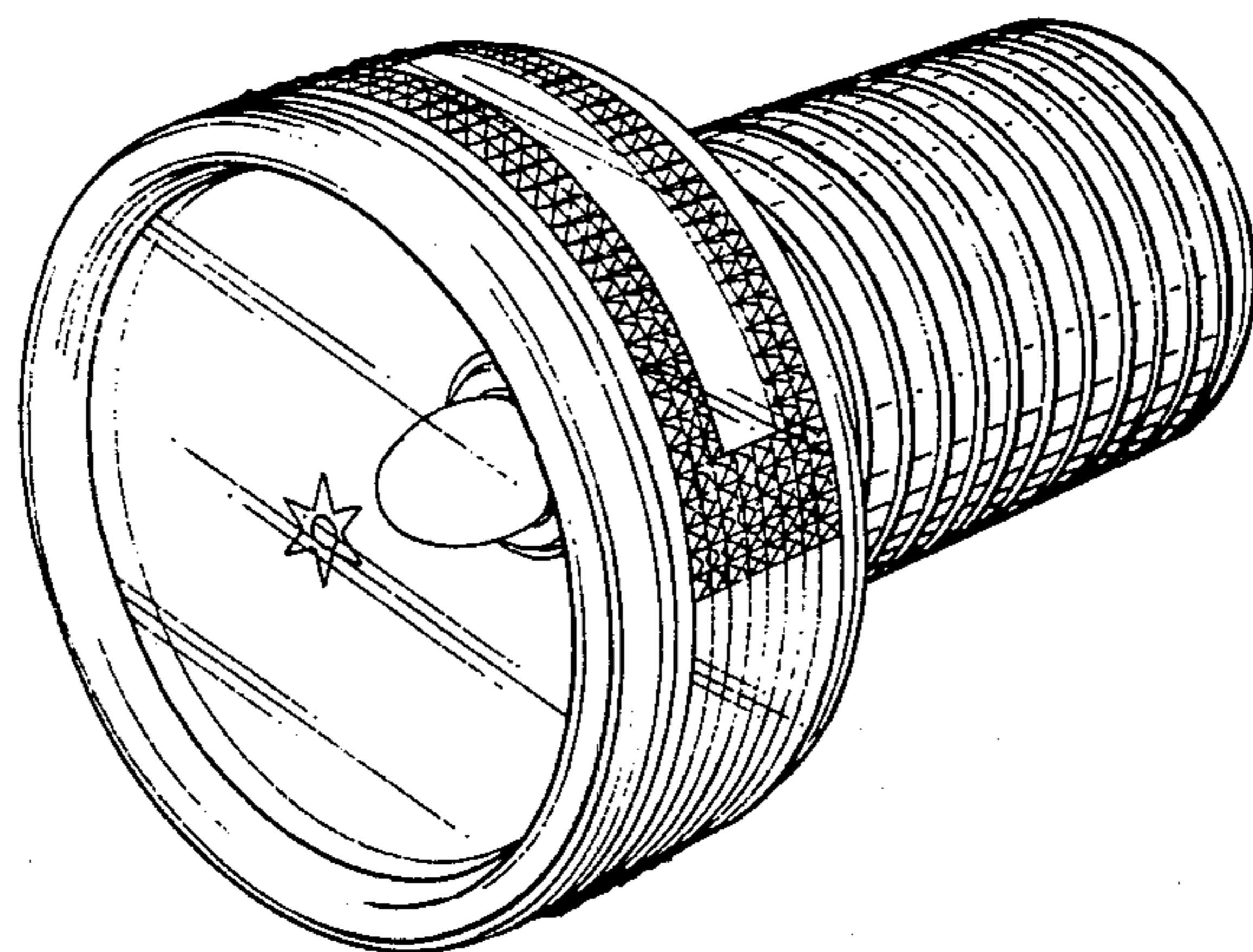

FIG. 1

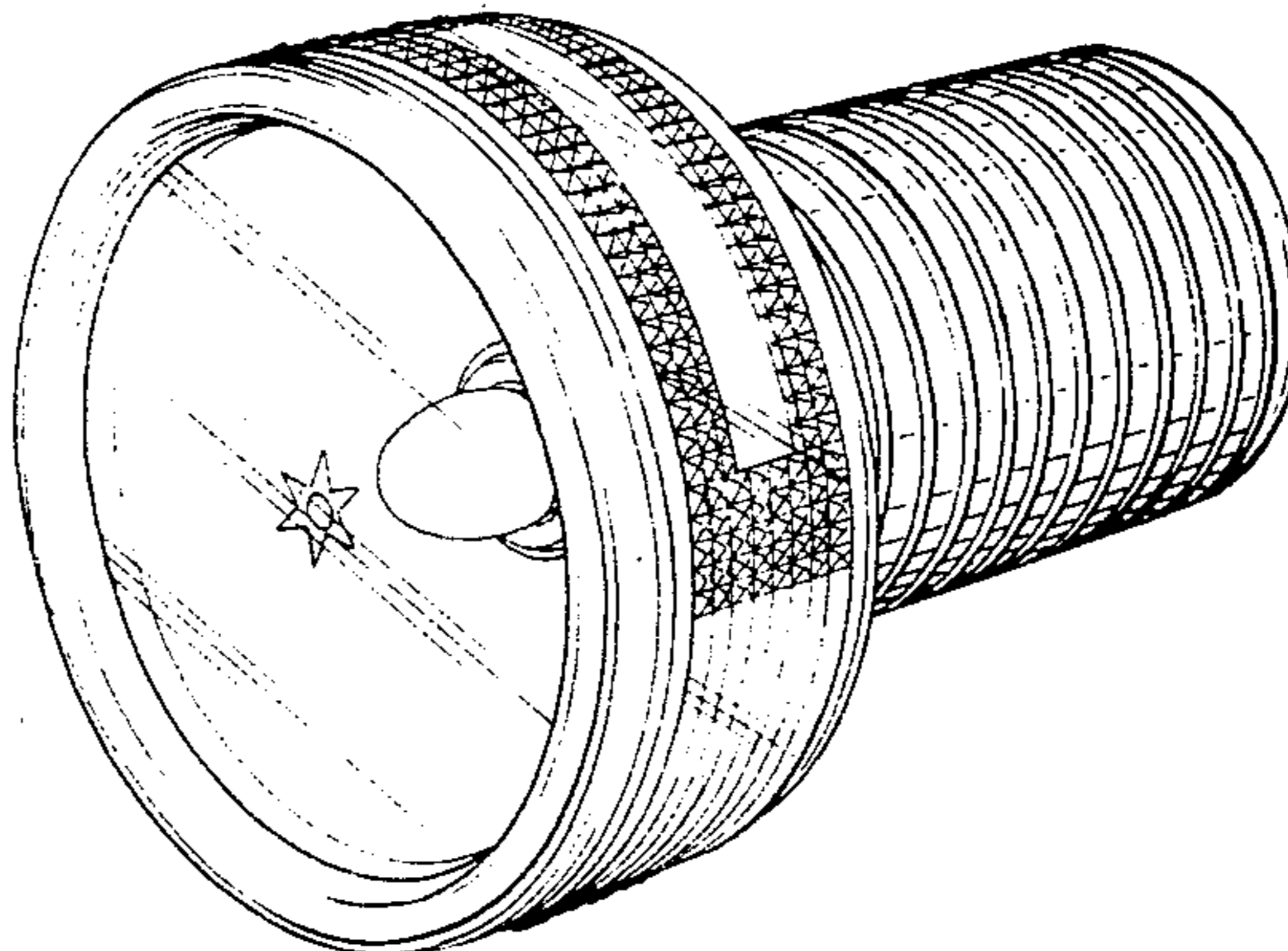

FIG. 2

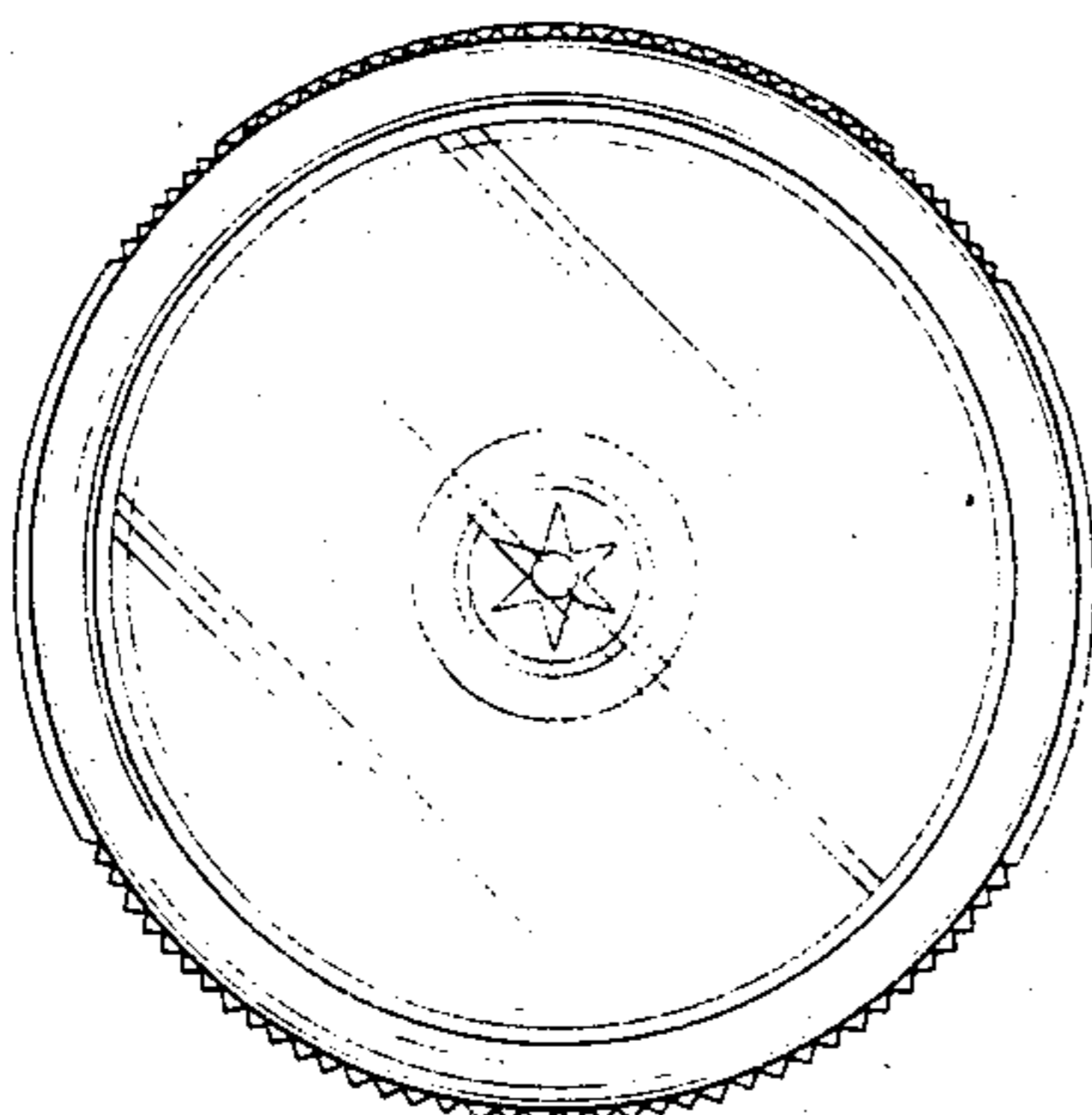

FIG. 3

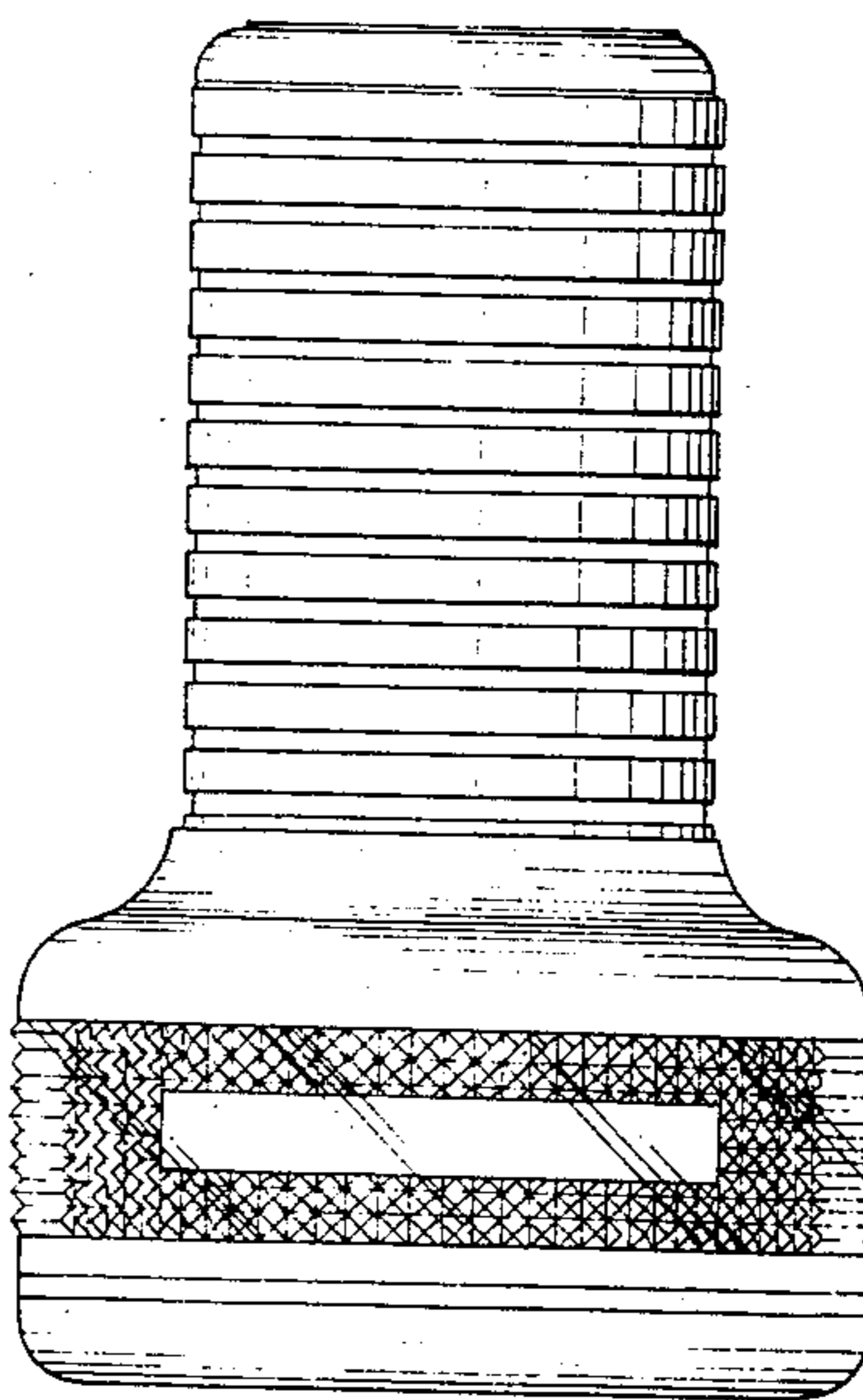

FIG. 4

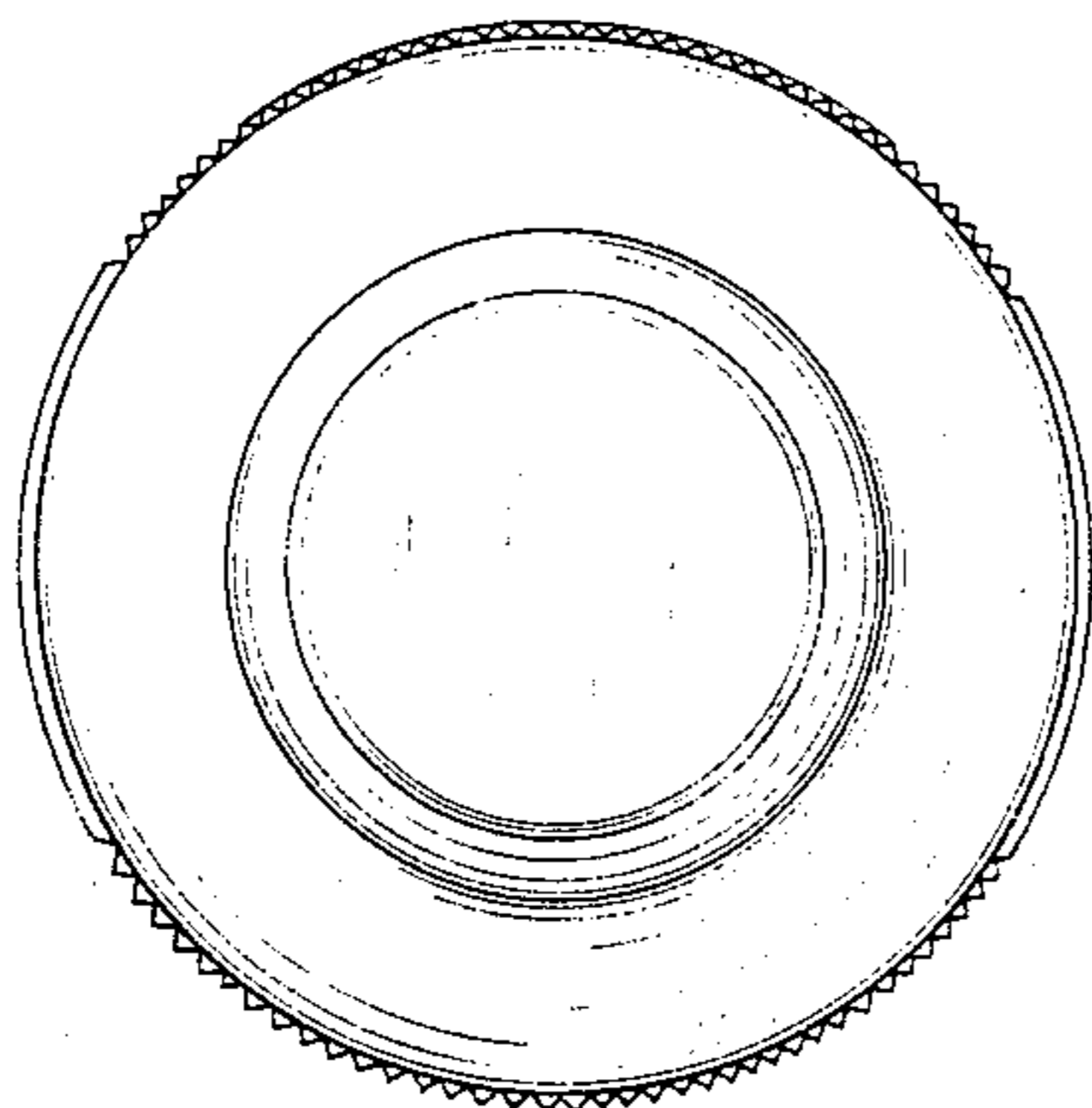

FIG. 5

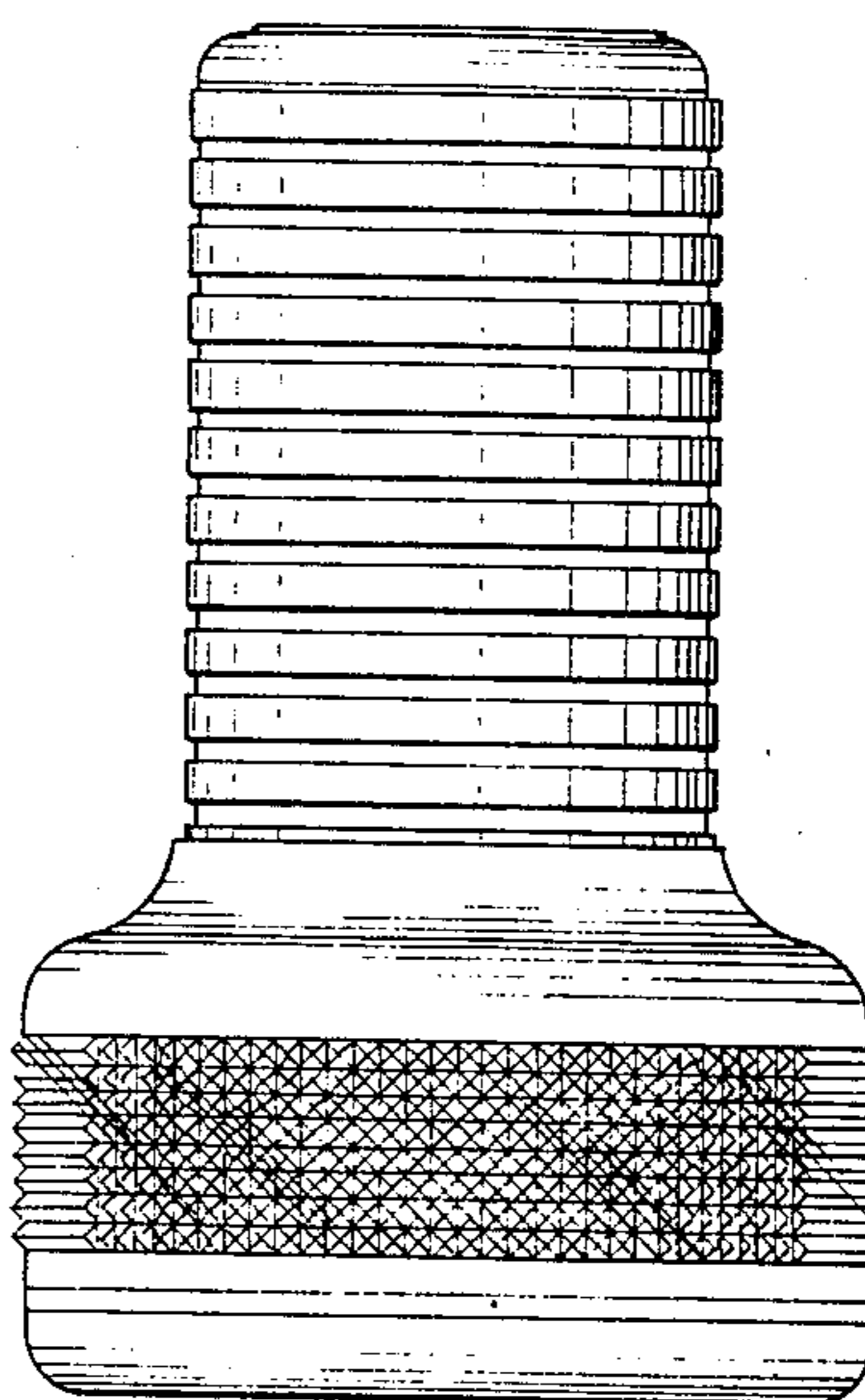

FIG. 6

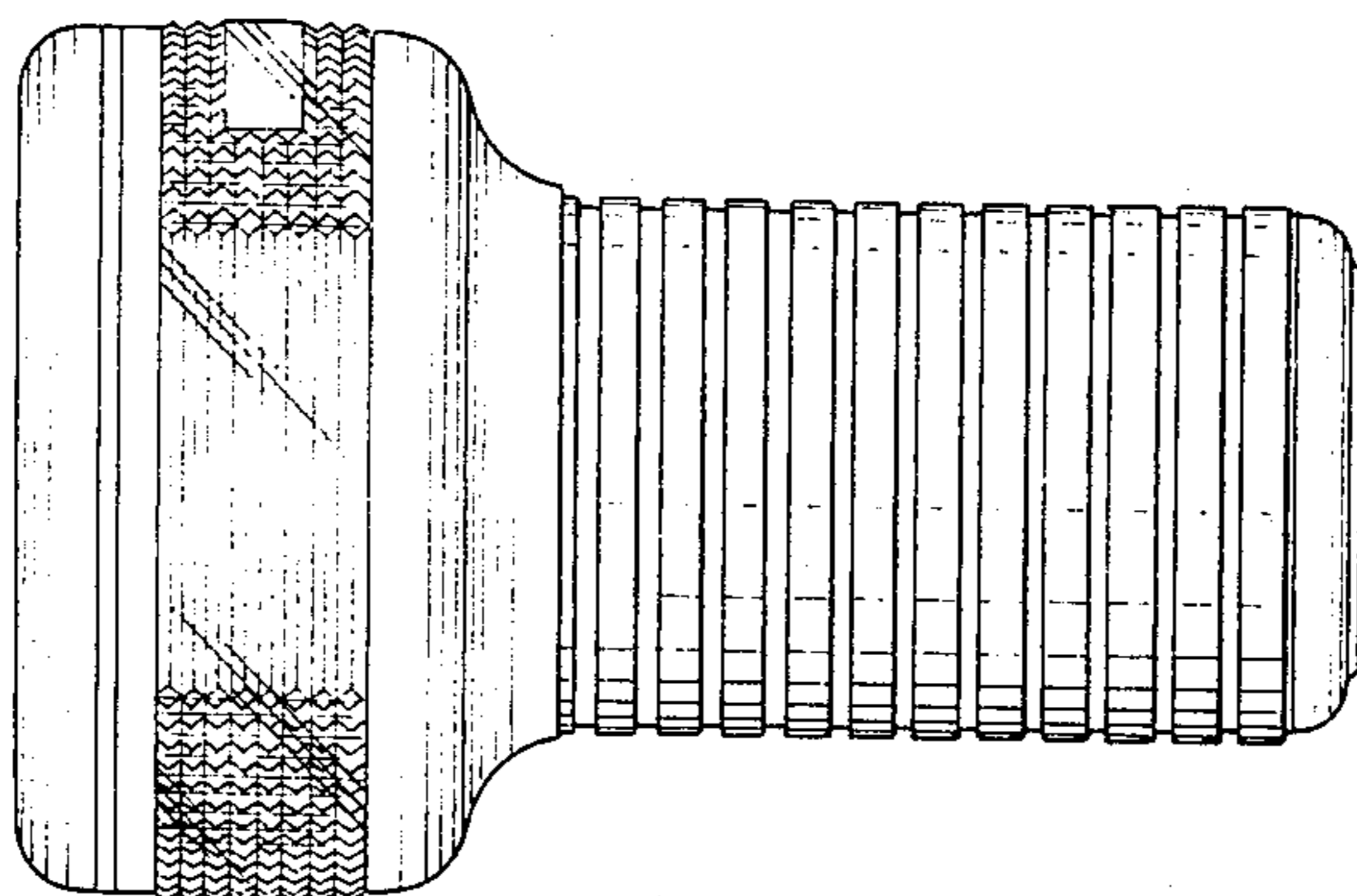

FIG. 7

