

[54] WHIRLPOOL BATHTUB

[75] Inventor: Kent A. Dowse, Coon Rapids, Minn.

[73] Assignee: Pearl Baths Inc., Minneapolis, Minn.

[\*\*] Term: 14 Years

[21] Appl. No.: 875,379

[22] Filed: Jun. 16, 1986

[52] U.S. Cl. .... D24/38

[58] Field of Search ..... D24/38; D4/488, 538, D4/546, 548, 552, 559, 560, 566, 576, 579, 580, 584, 513, 568, 590, 592; D23/55, 56, 49; D25/2; 128/36.9, 66

[56] References Cited

U.S. PATENT DOCUMENTS

- D. 254,387 3/1980 Ogden ..... D24/38 X
- D. 254,870 4/1980 Ogden ..... D24/38
- D. 286,679 11/1986 D'Innocente et al. .... D24/38
- 4,383,340 5/1983 Braun, Jr. .... 4/541

Primary Examiner—A. Hugo Word  
Assistant Examiner—Stella M. Reid  
Attorney, Agent, or Firm—James V. Harmon

[57] CLAIM

The ornamental design for a whirlpool bathtub, as shown.

DESCRIPTION

FIG. 1 is a perspective view of a whirlpool bathtub showing my new design;  
 FIG. 2 is a top plan view thereof;  
 FIG. 3 is a left side elevational view thereof;  
 FIG. 4 is a right side elevational view thereof;  
 FIG. 5 is a bottom plan view thereof;  
 FIG. 6 is a rear elevational view thereof;  
 FIG. 7 is a front elevational view thereof;  
 FIG. 8 is a perspective view of a second embodiment of the whirlpool bathtub shown in FIG. 1, in which the whirlpool bathtub is a larger size;  
 FIG. 9 is a top plan view thereof;  
 FIG. 10 is a left side elevational view thereof;  
 FIG. 11 is a right side elevational view thereof;  
 FIG. 12 is a bottom plan view thereof;  
 FIG. 13 is a rear elevational view thereof; and  
 FIG. 14 is a front elevational view thereof.  
 The lined shading on the outside surface of the tub in FIGS. 3-7 represent an unfinished fiberglass with resin appearance.

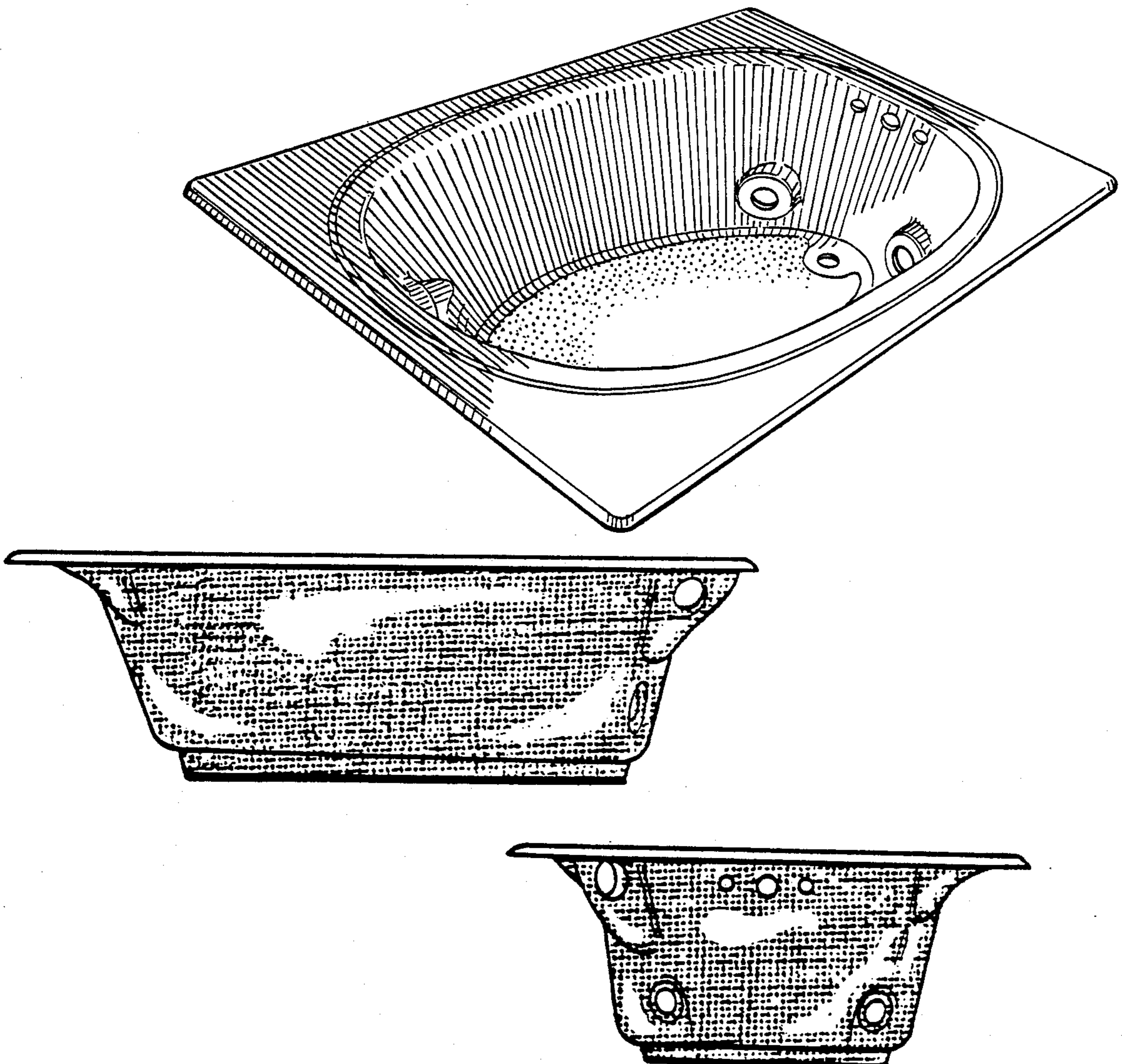

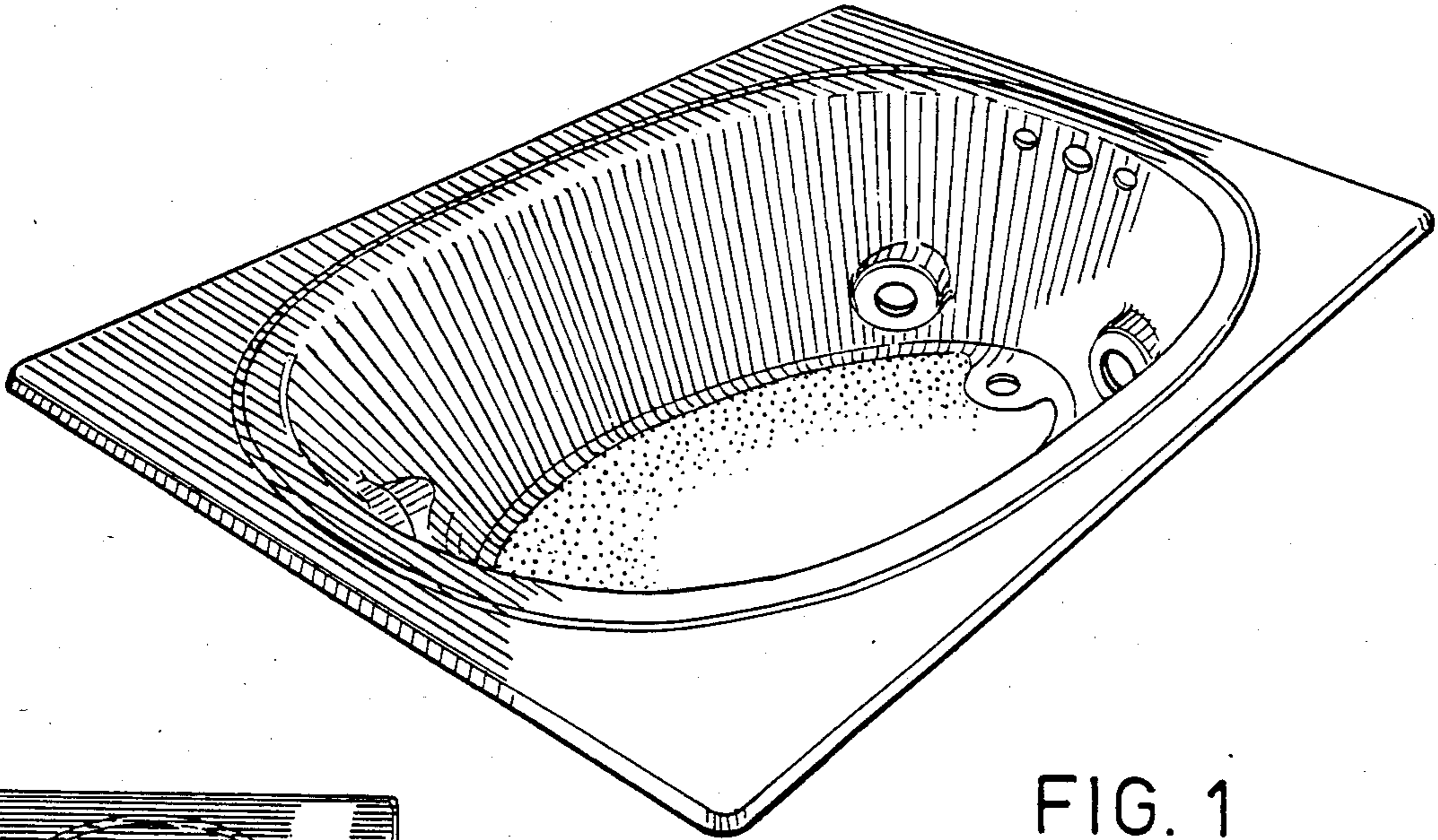

FIG. 1

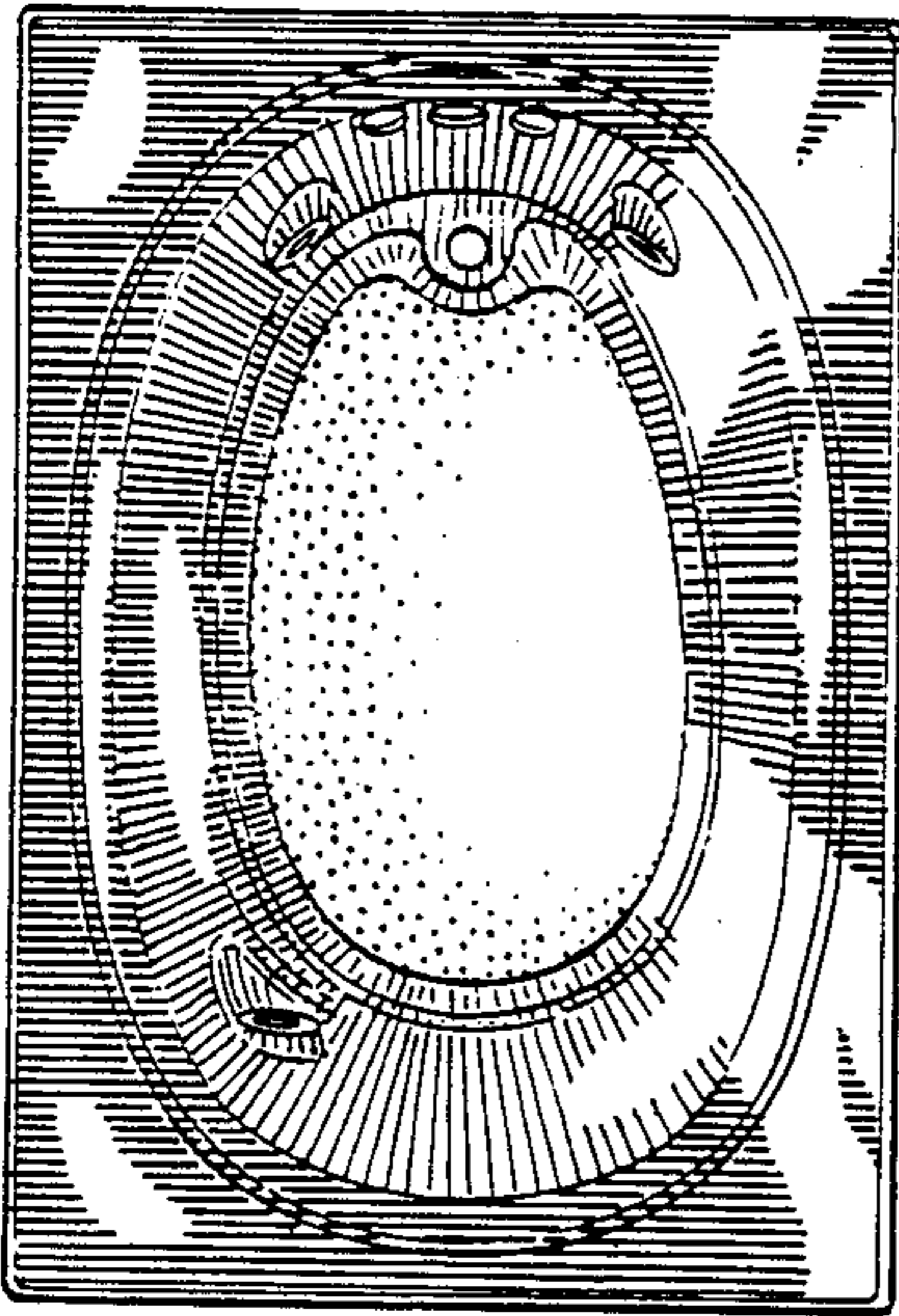

FIG. 2

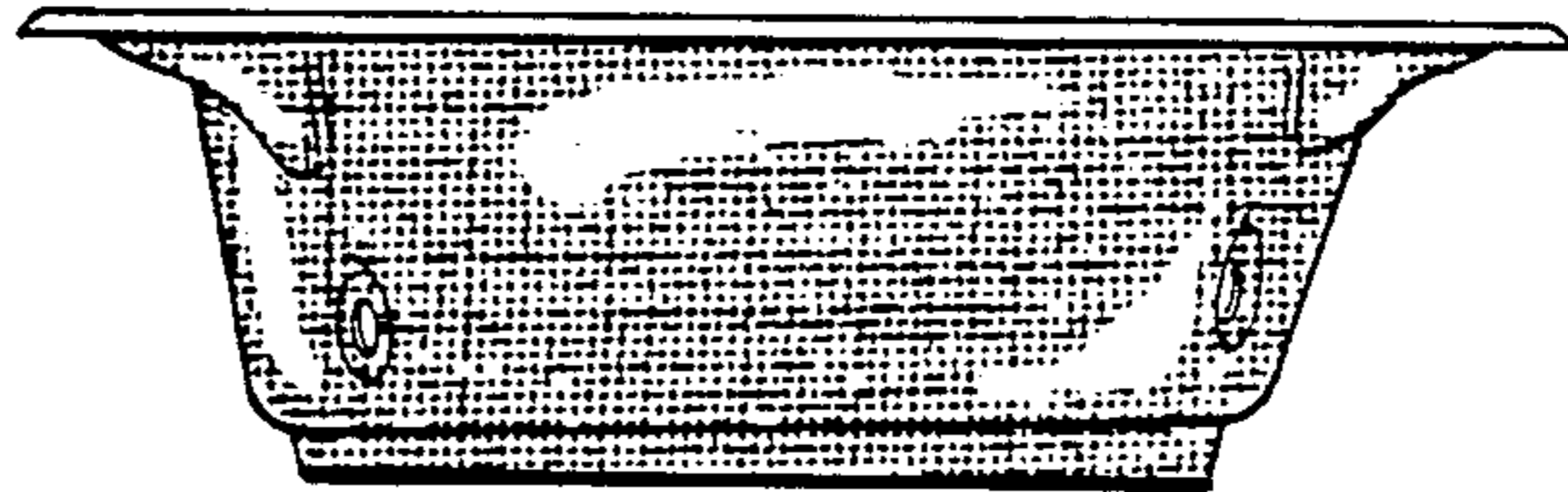

FIG. 3

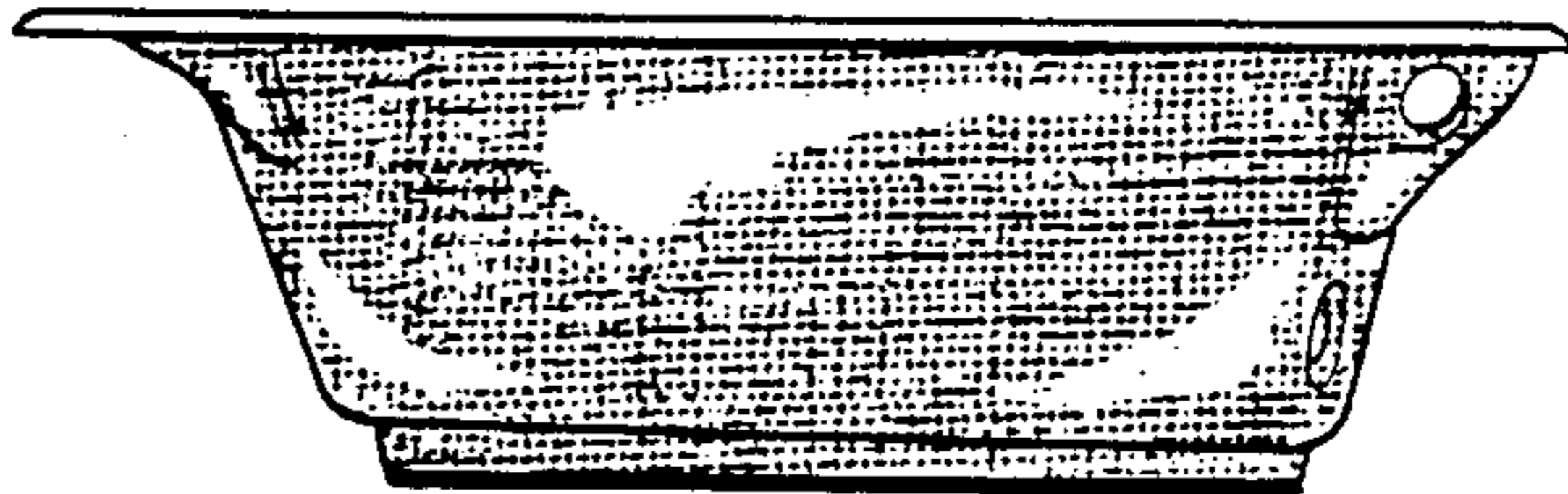

FIG. 4

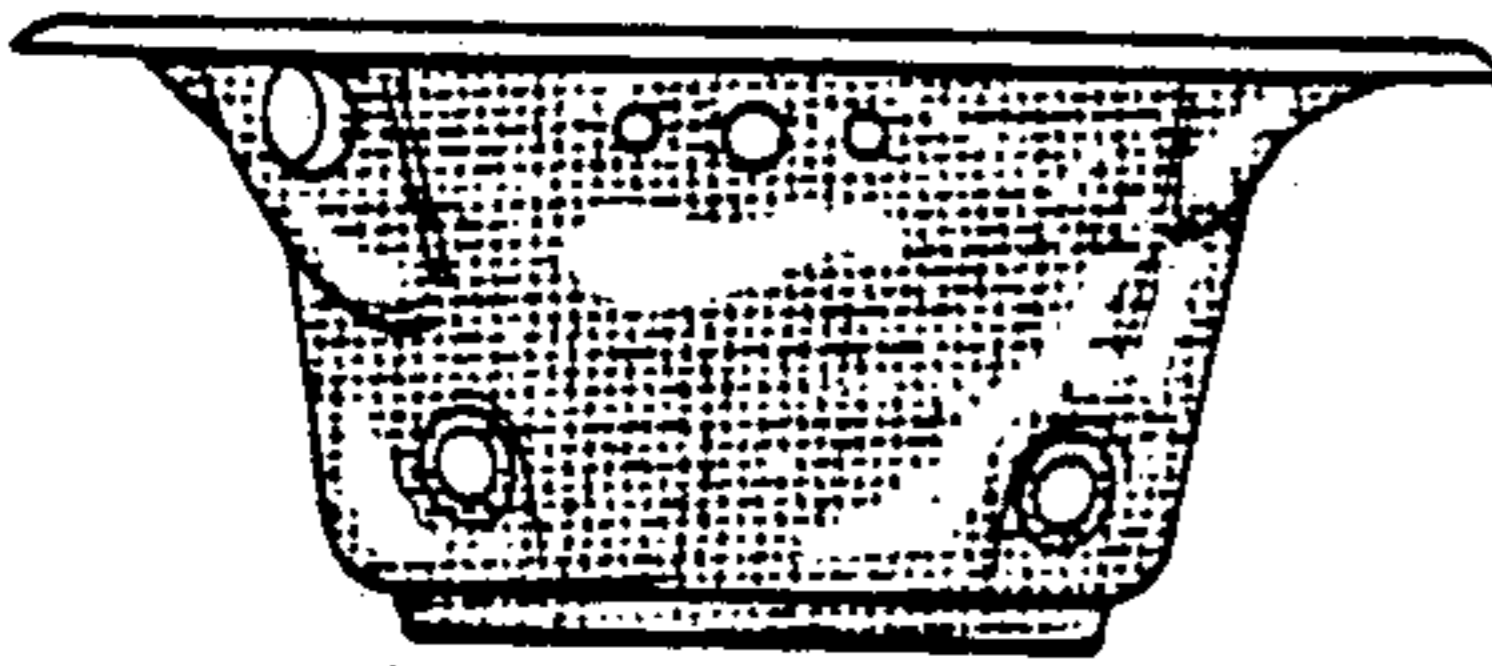

FIG. 6

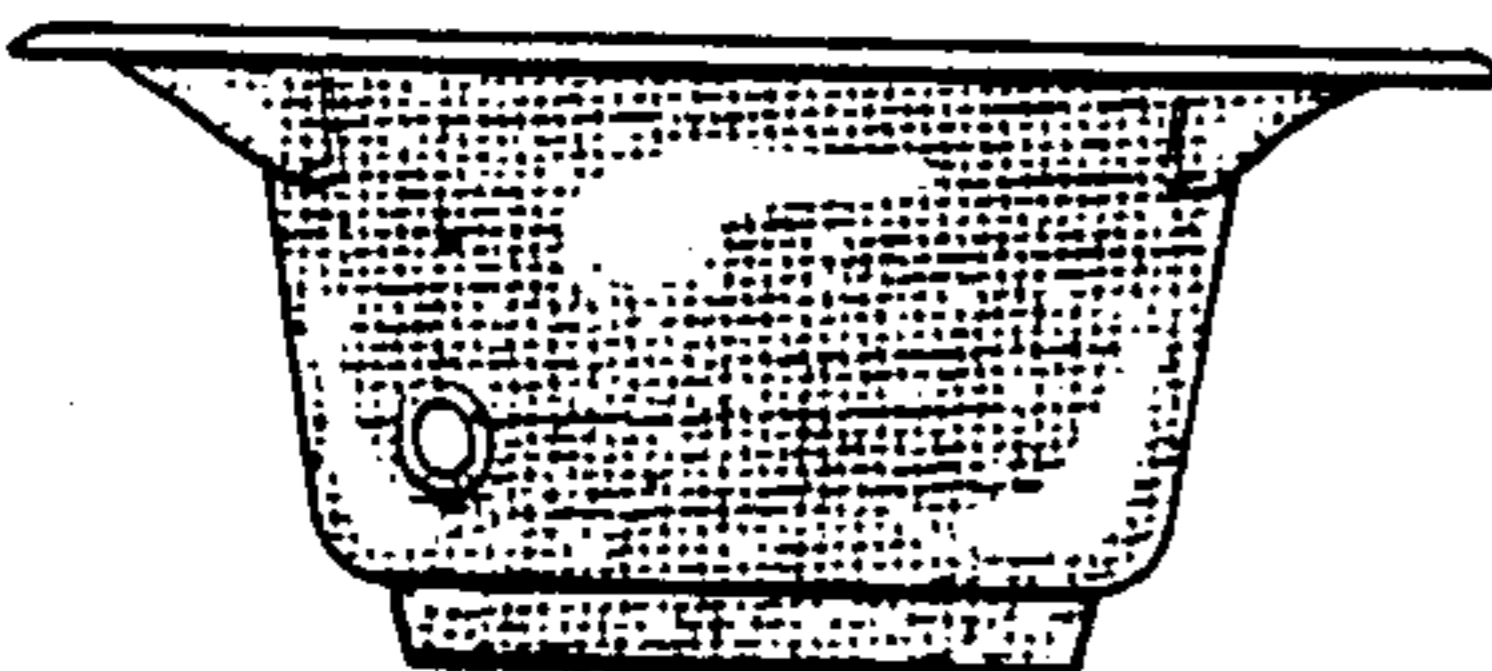

FIG. 7

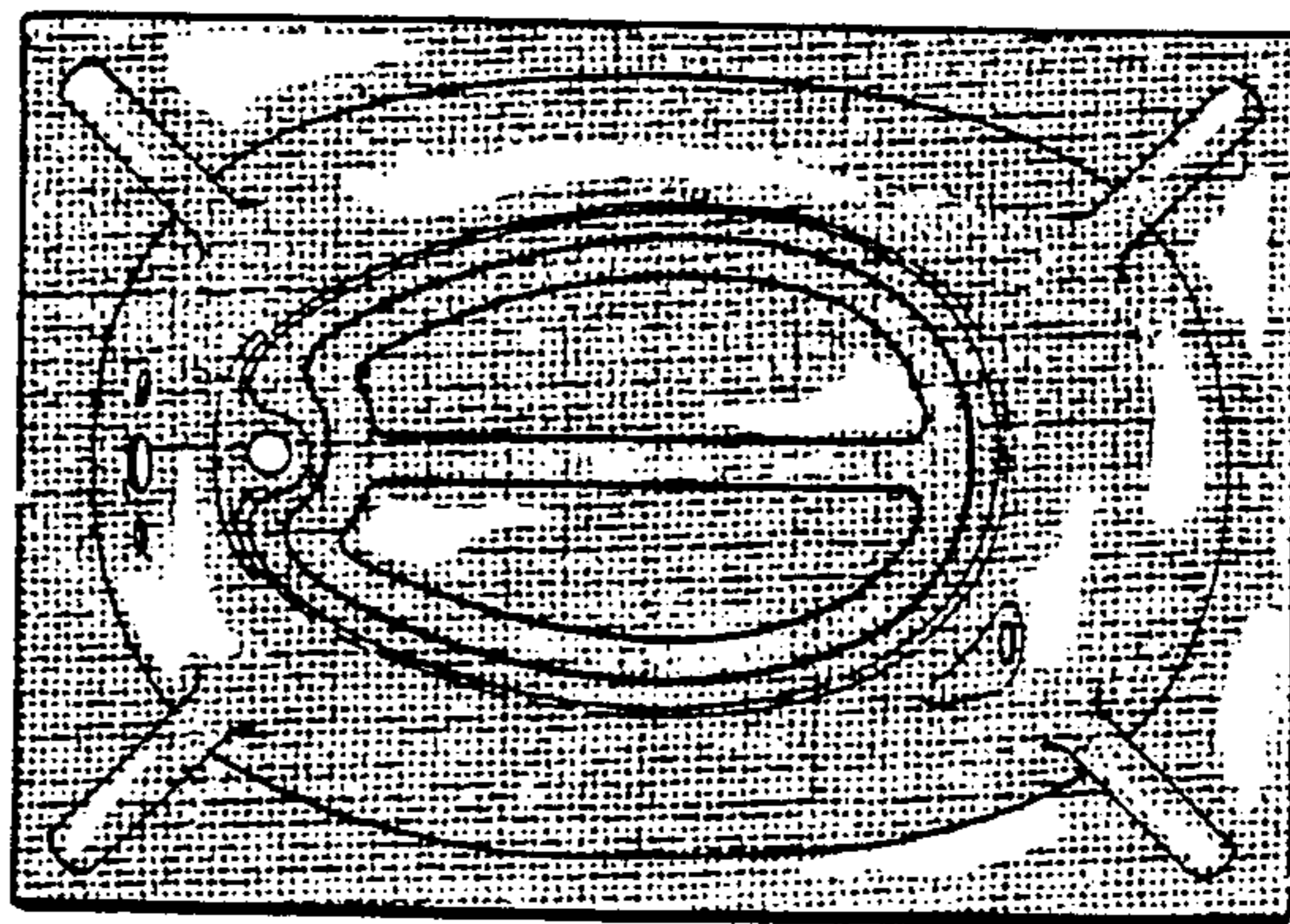

FIG. 5

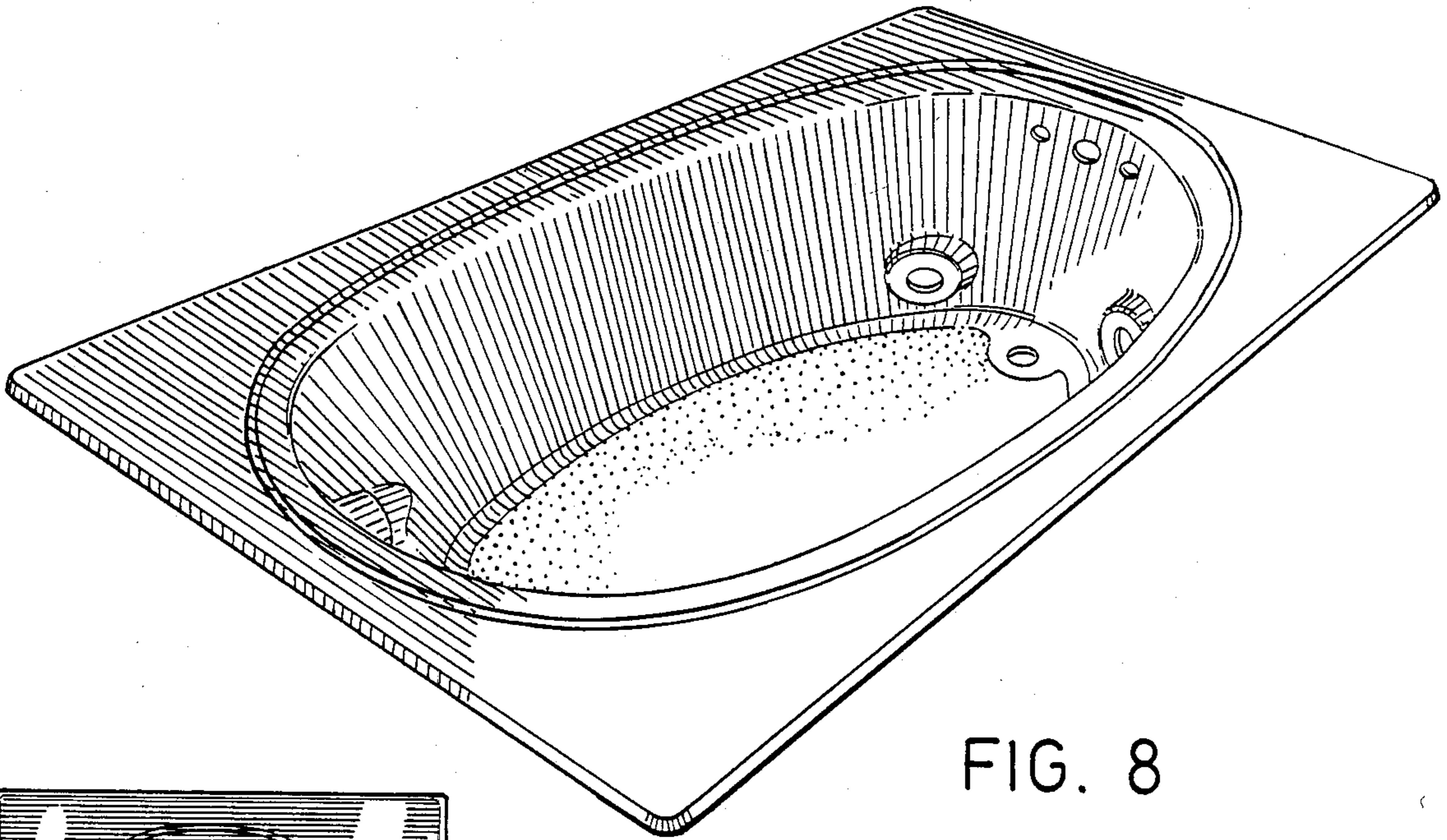

FIG. 8

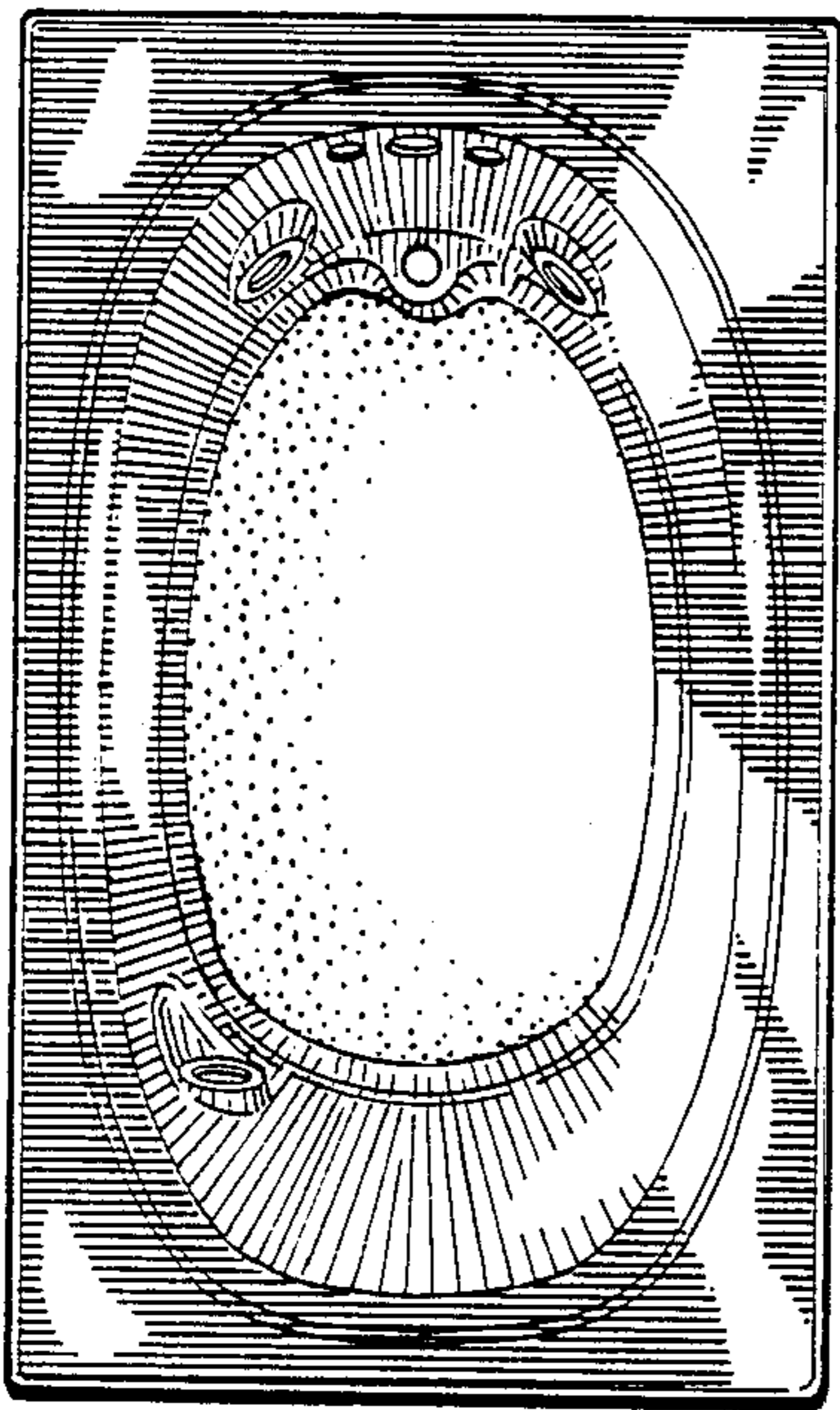

FIG. 9

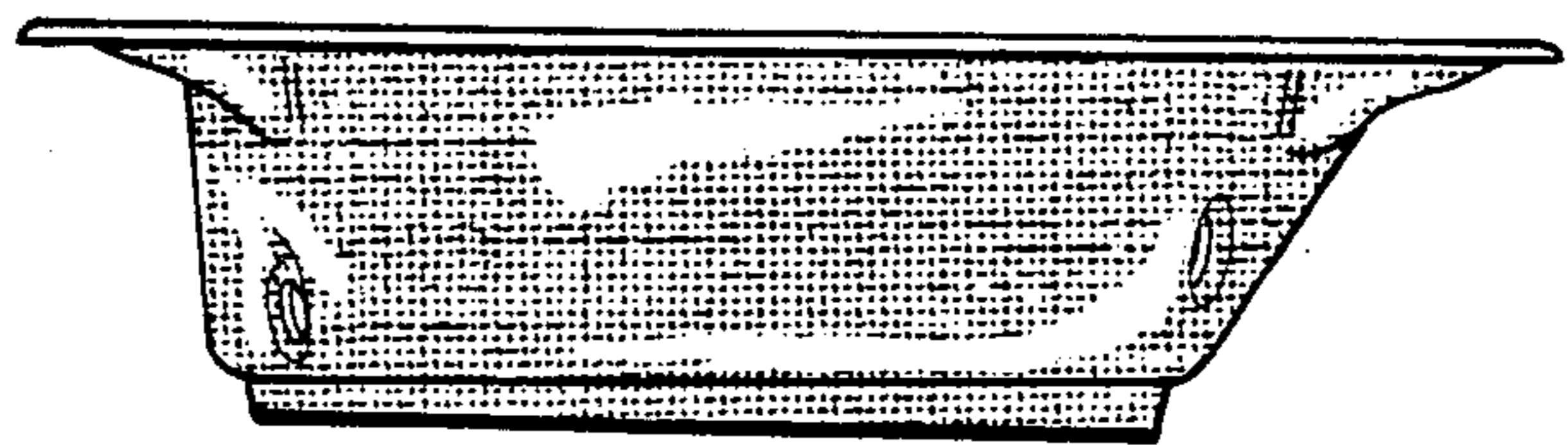

FIG. 10

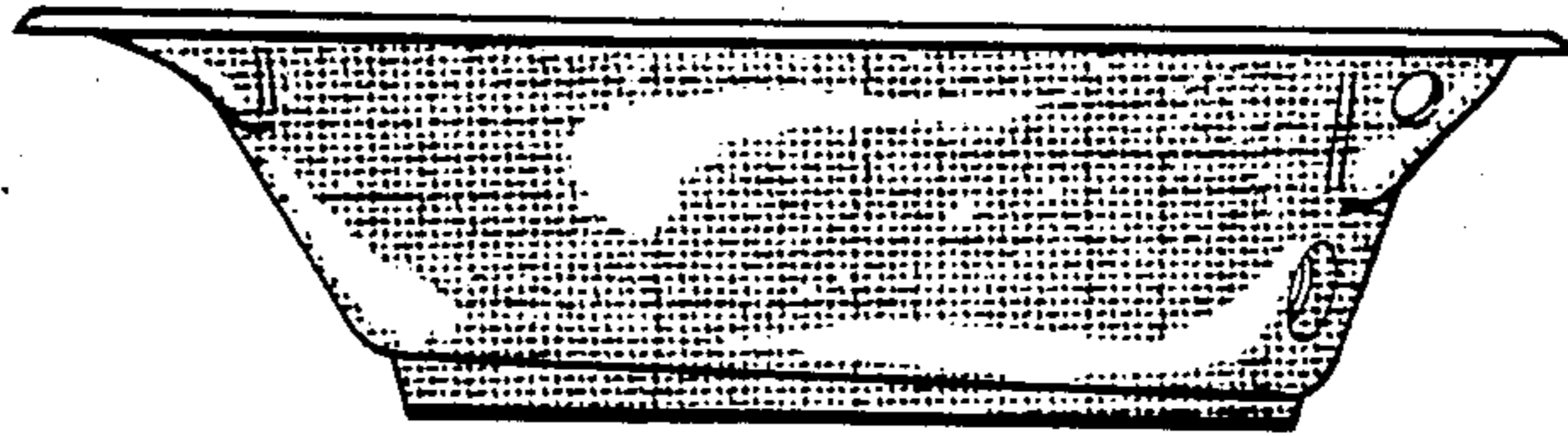

FIG. 11

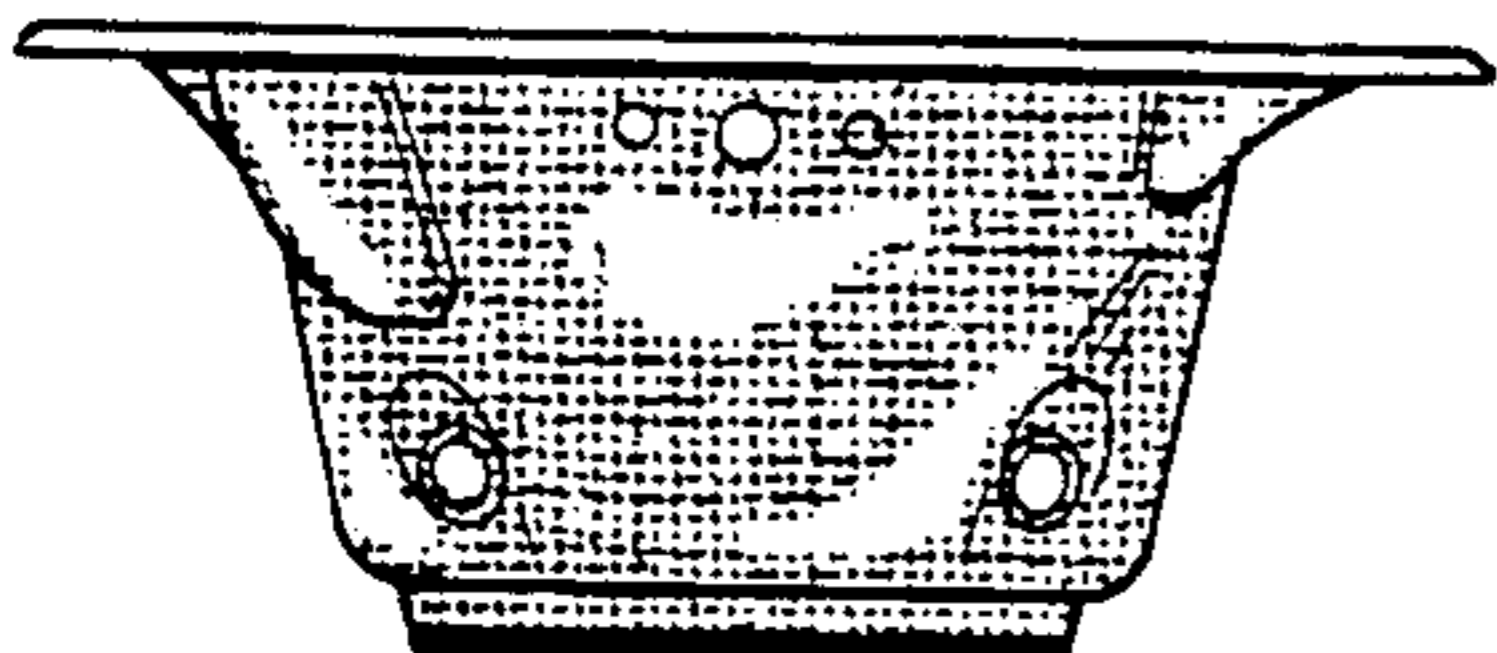

FIG. 13

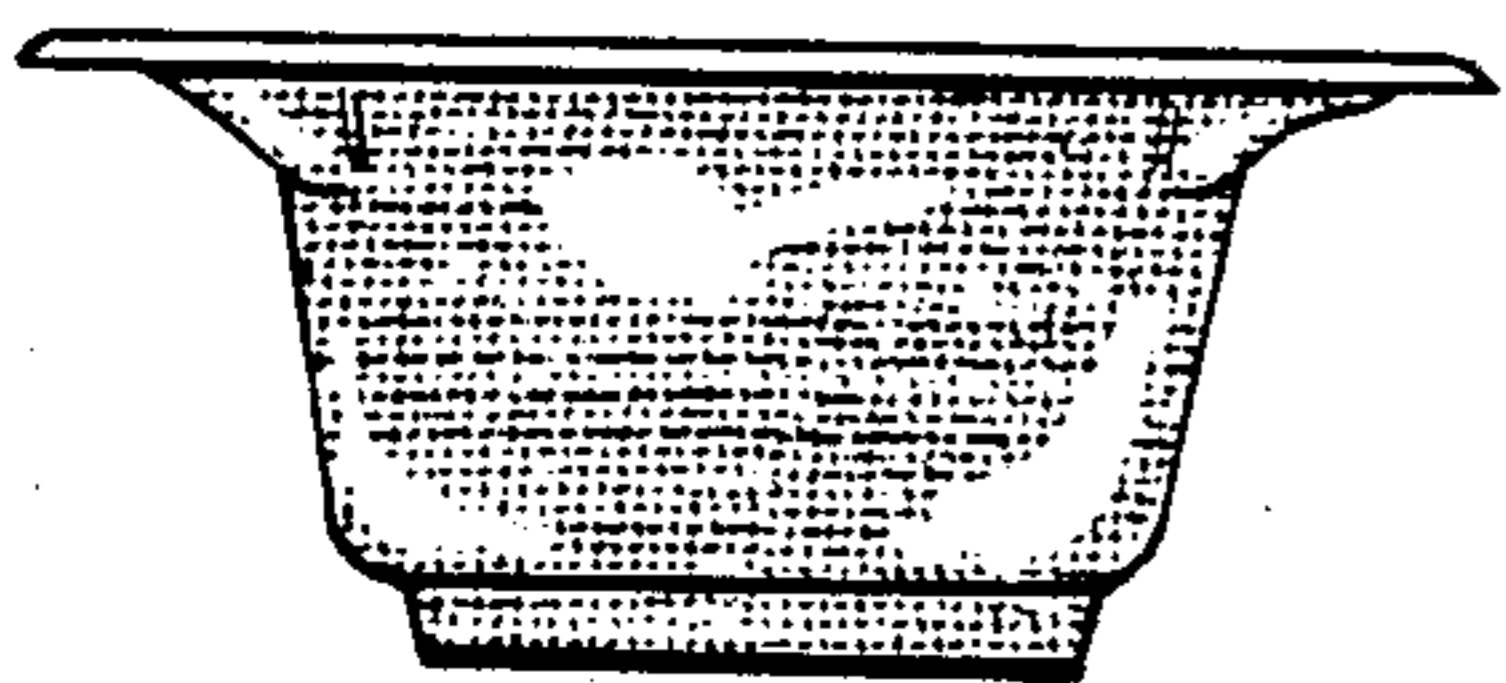

FIG. 14

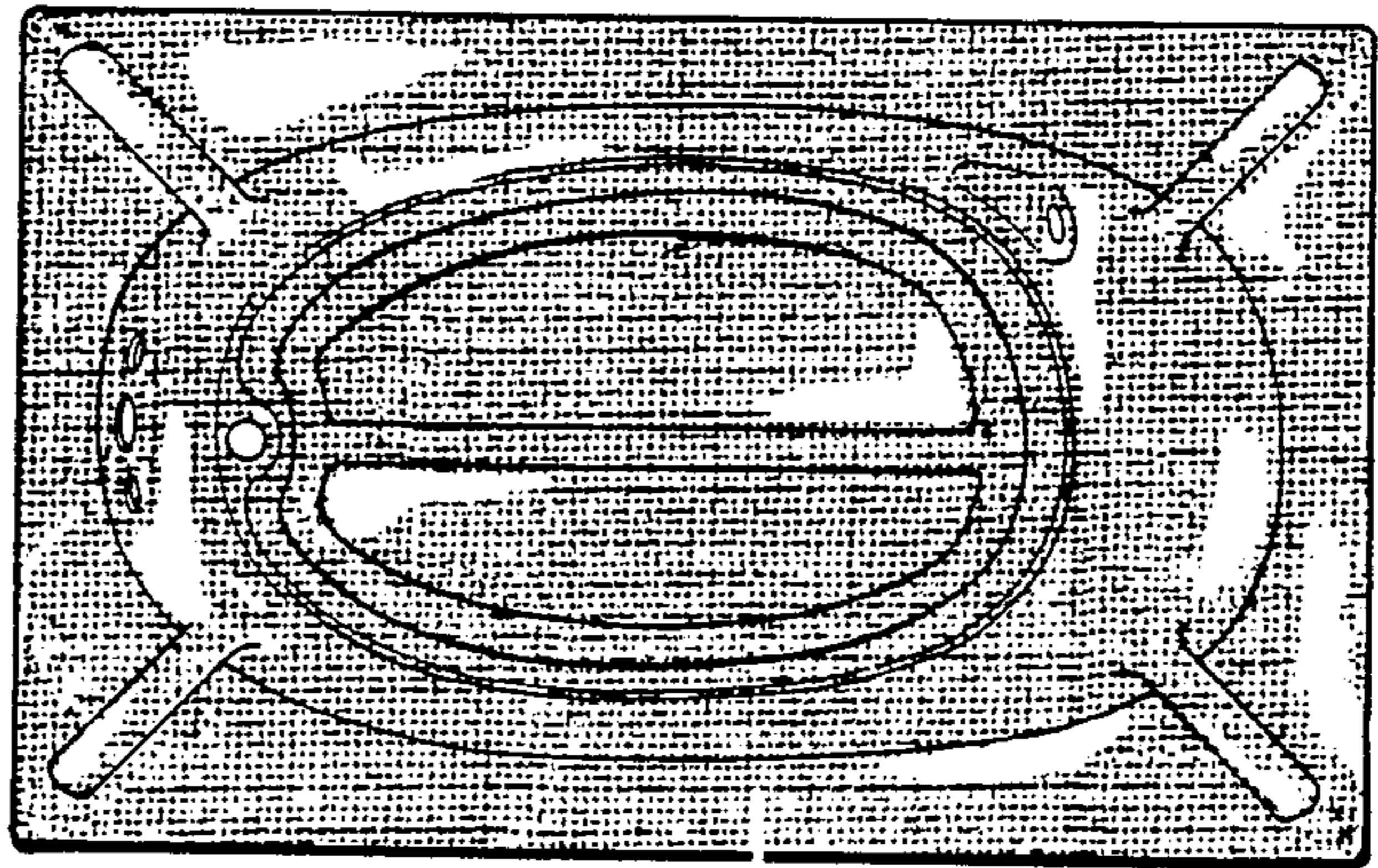

FIG. 12