

[54] **FIREPLACE INSERT SMOKE PIPE CONNECTOR**

[76] **Inventor:** Thomas E. Buehler, 3010 18th Ave. W., Bradenton, Fla. 33505

[**] **Term:** 14 Years

[21] **Appl. No.:** 825,106

[22] **Filed:** Feb. 3, 1986

[52] **U.S. Cl.** D23/403

[58] **Field of Search** D23/342-350,
D23/393, 394, 403; 126/4, 6, 58, 60-66, 120,
121, 123, 126

[56] **References Cited**

U.S. PATENT DOCUMENTS

D. 263,735 4/1982 Oskwarek D23/403

Primary Examiner—Susan J. Lucas

Attorney, Agent, or Firm—Charles S. McGuire

[57] **CLAIM**

The ornamental design for fireplace insert smoke pipe connector, as shown and described.

DESCRIPTION

FIG. 1 is a front perspective view of a fireplace insert smoke pipe connector showing my new design; FIG. 2 is a top plan view thereof; FIG. 3 is a front elevational view thereof; FIG. 4 is a side elevational view, the opposite side being a mirror image thereof; FIG. 5 is a bottom plan view thereof; FIG. 6 is a rear elevational view thereof; and FIG. 7 is an enlarged front perspective view thereof. The broken line disclosure included in FIG. 1 is for illustrative purposes only and forms no part of the claimed design.

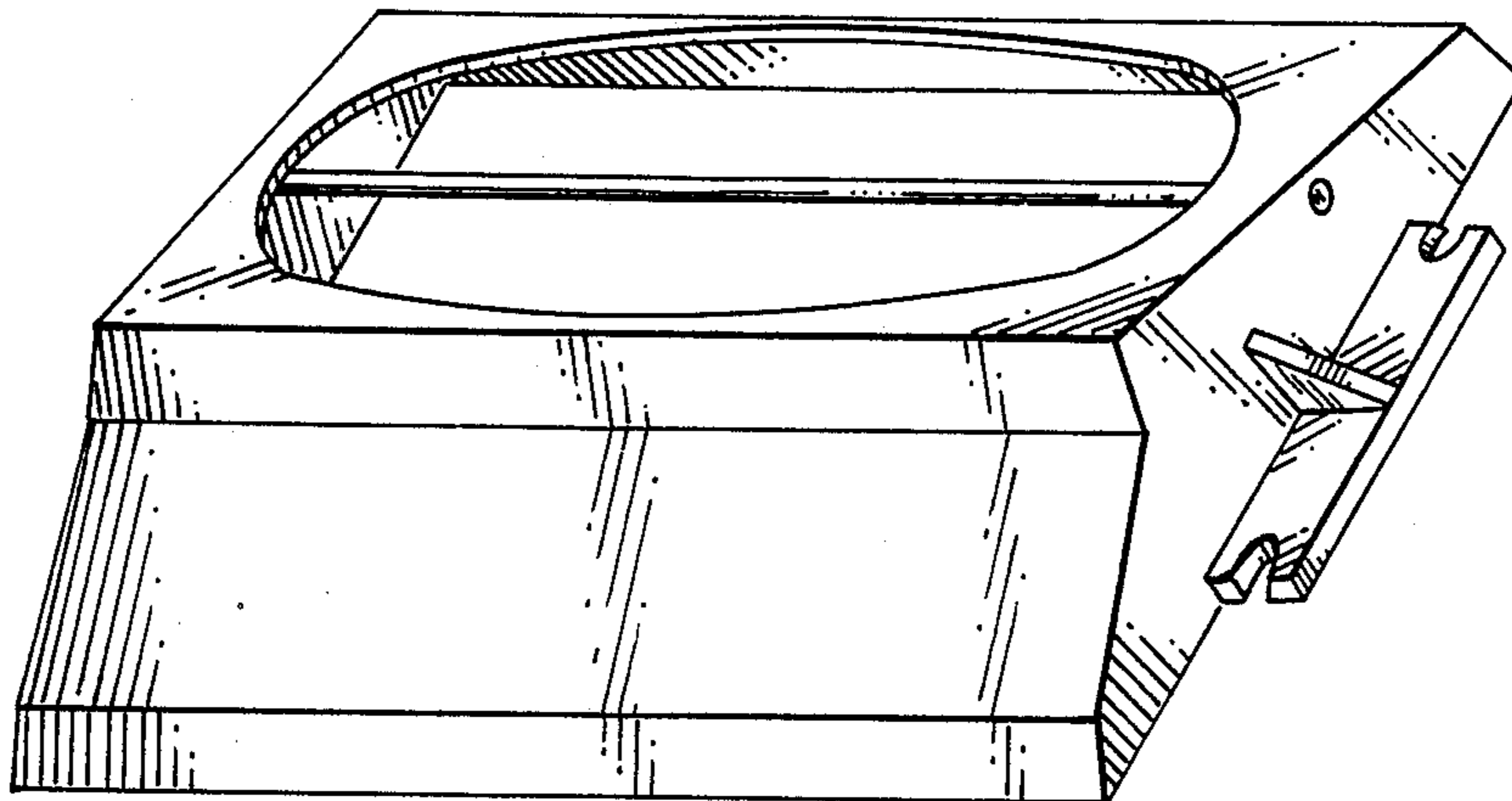

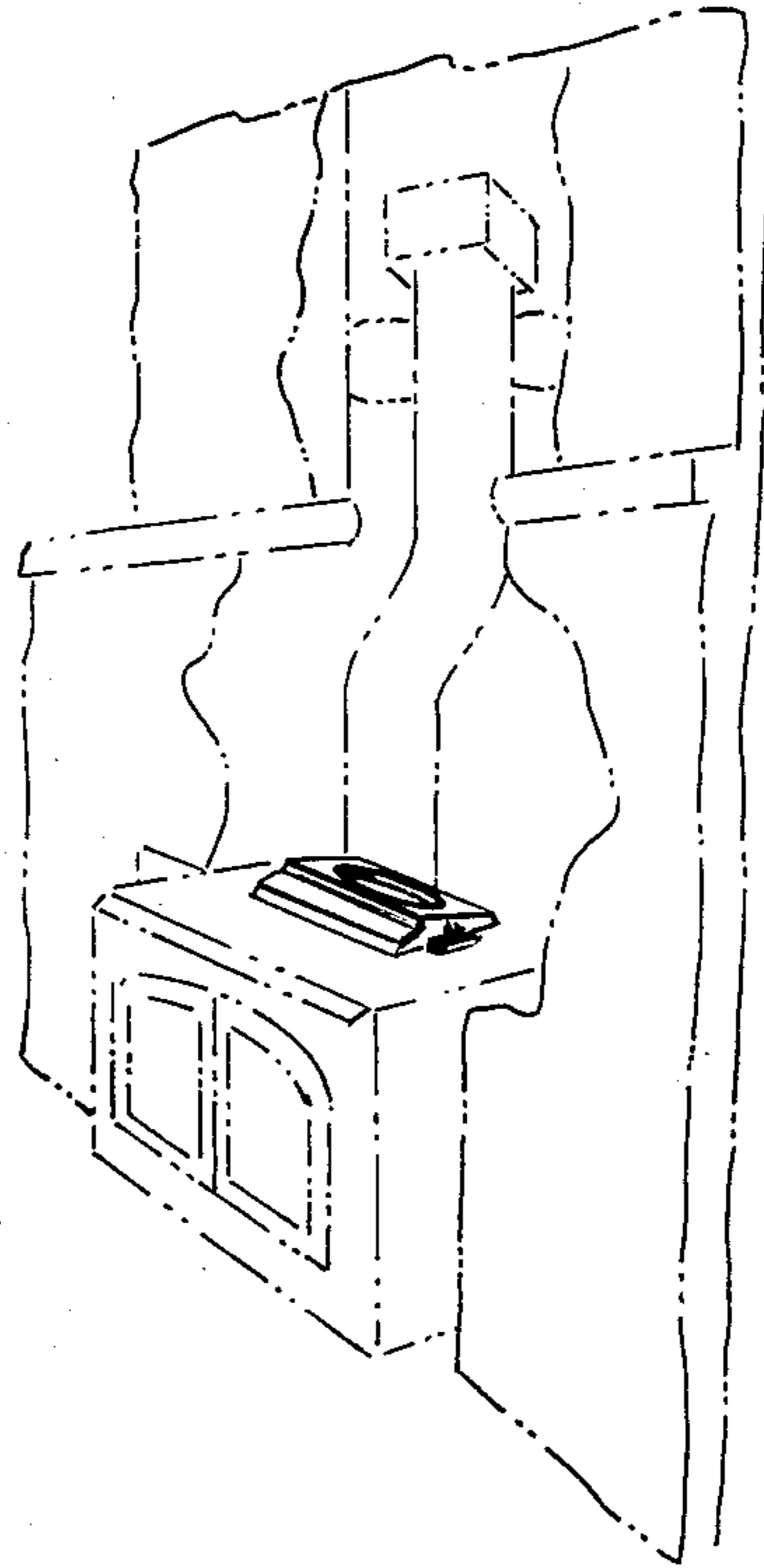

FIG. 1

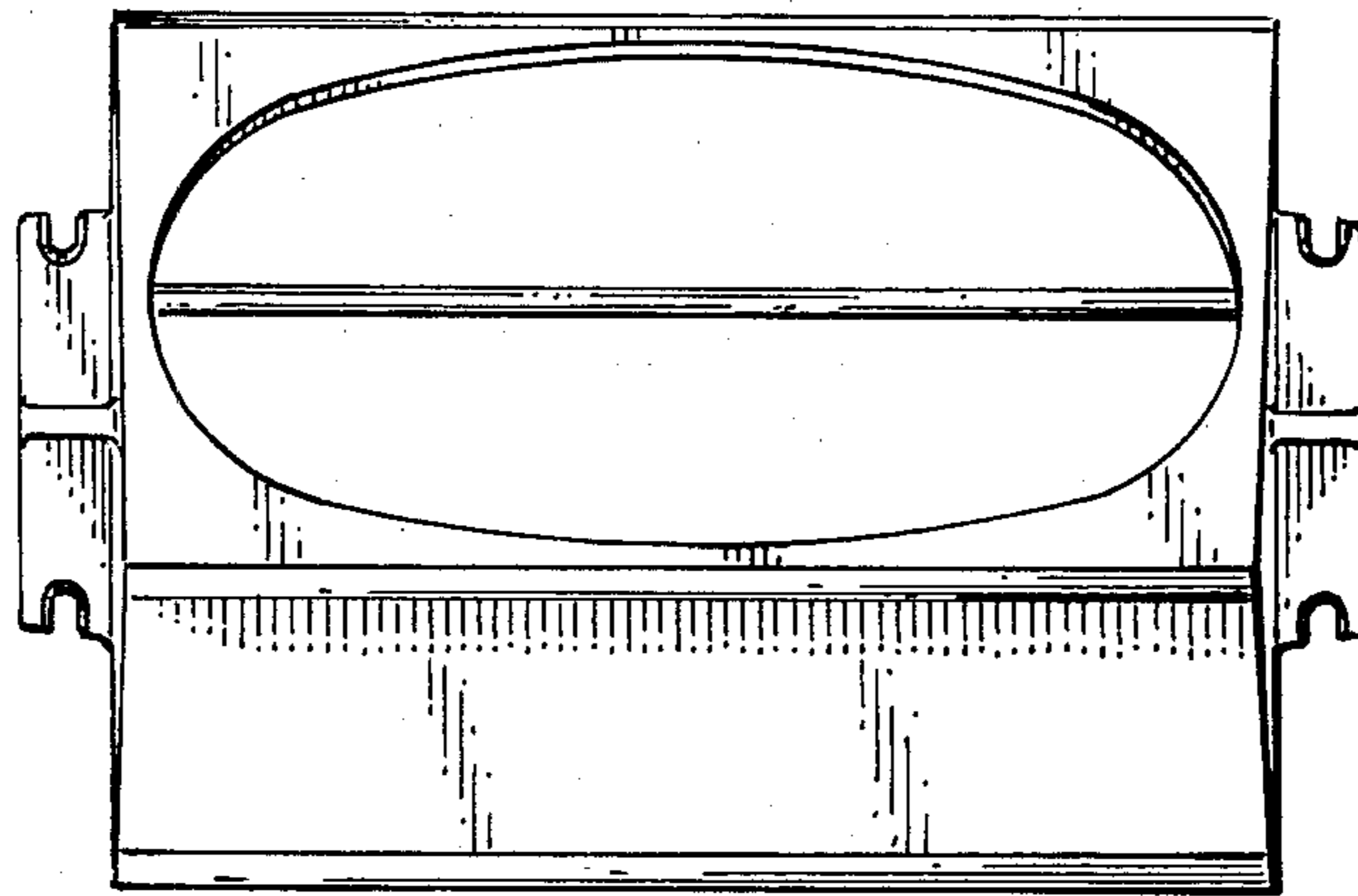

FIG. 2

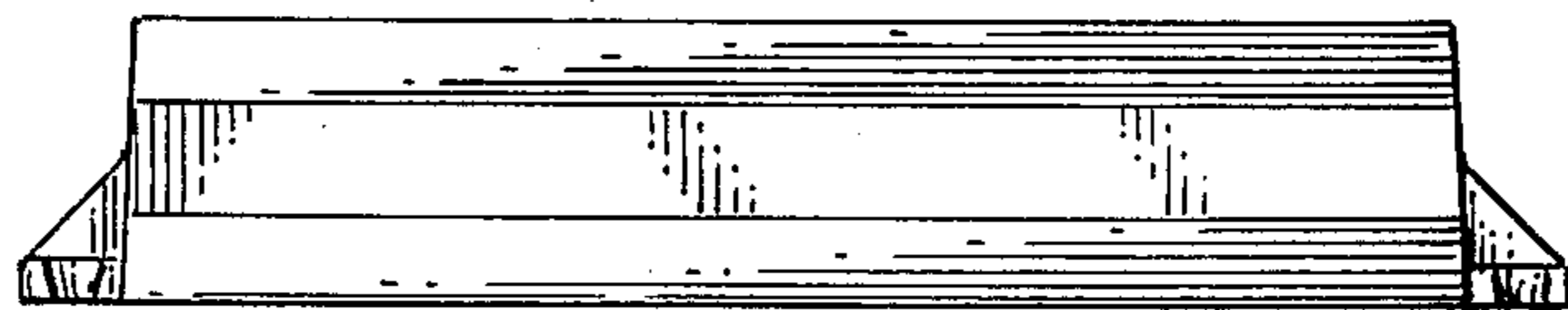

FIG. 3

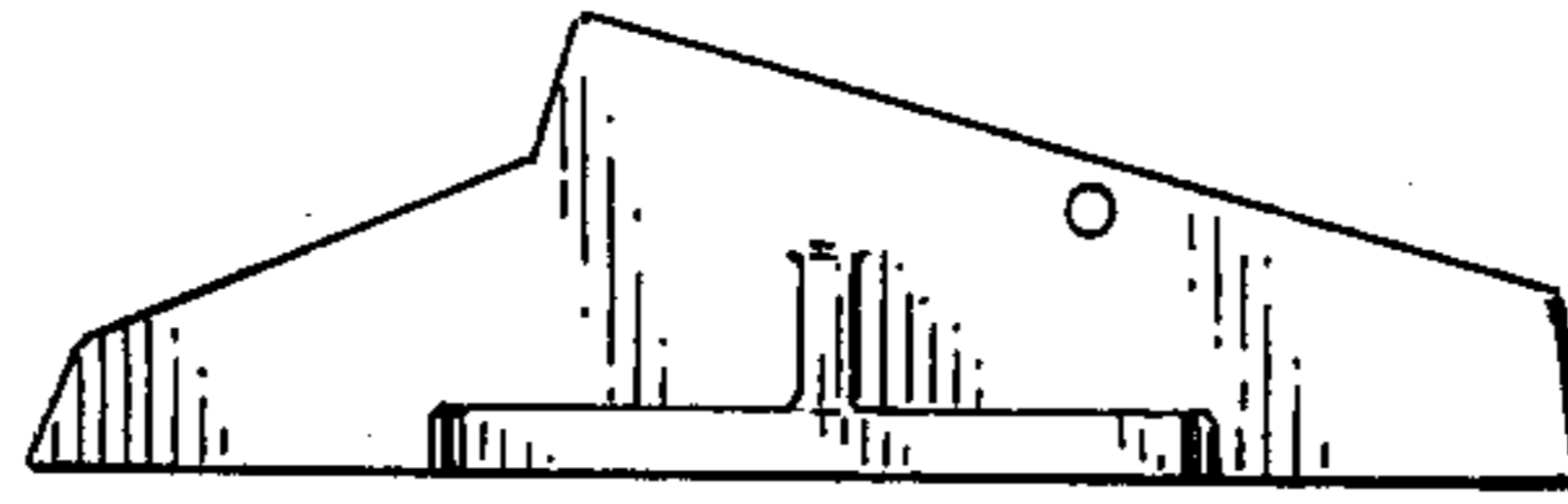

FIG. 4

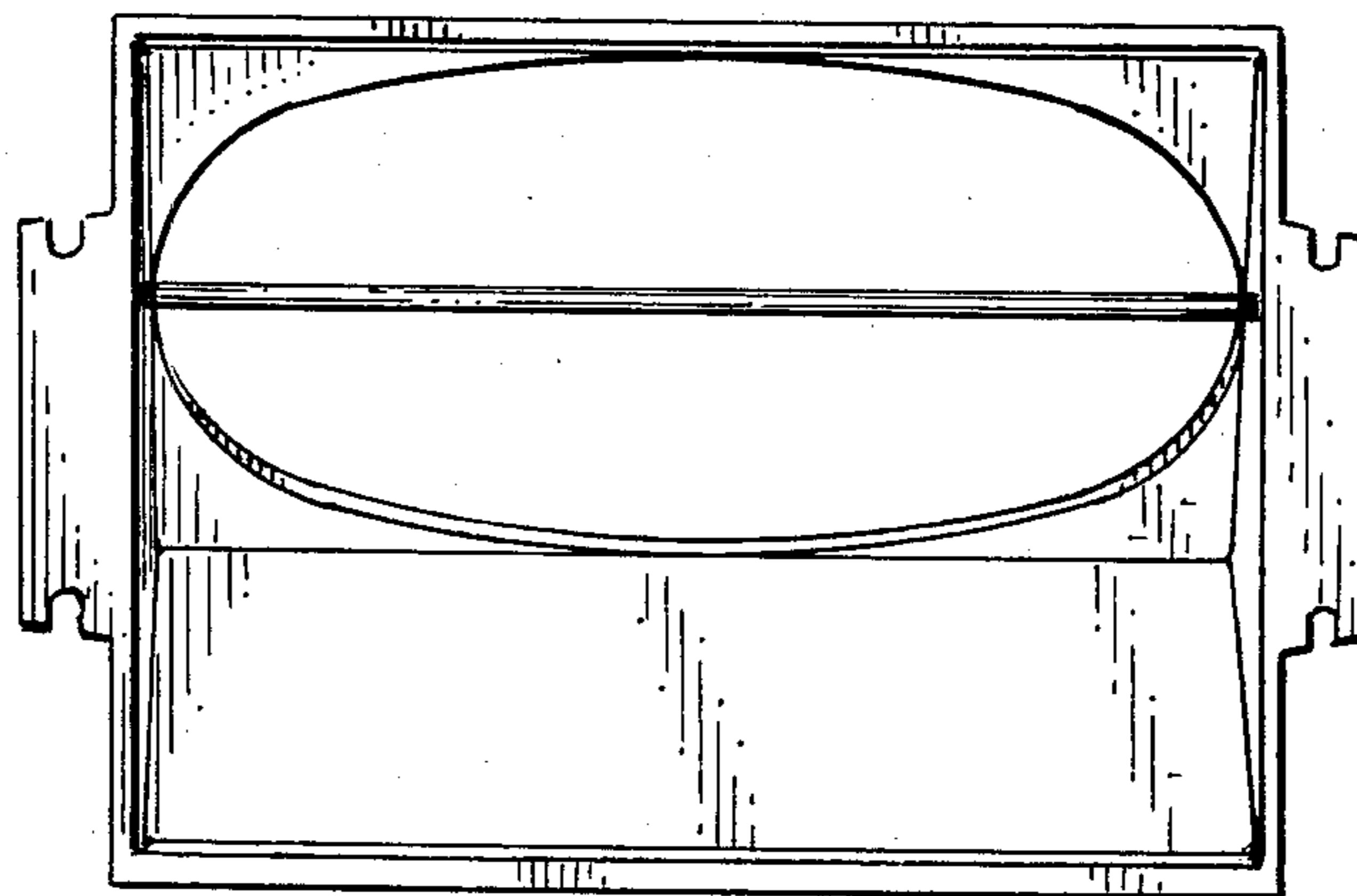

FIG. 5

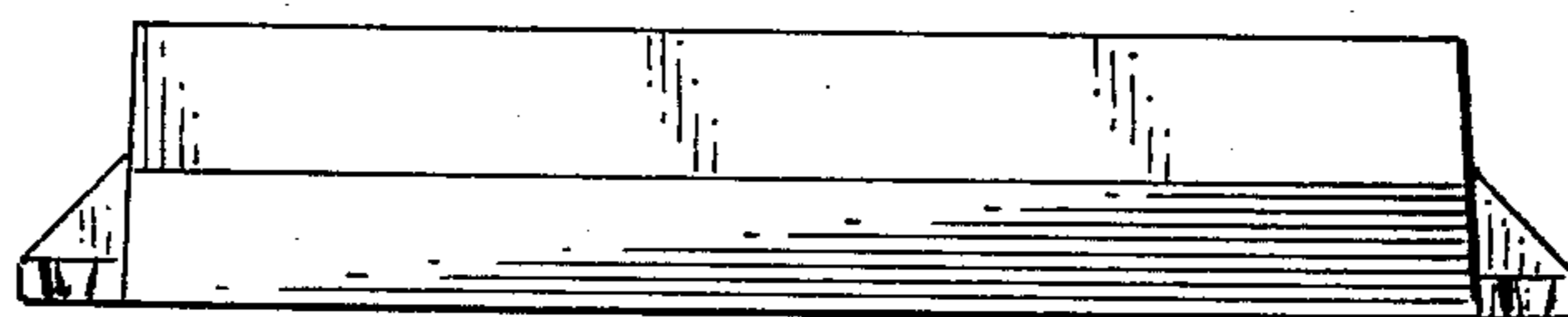

FIG. 6

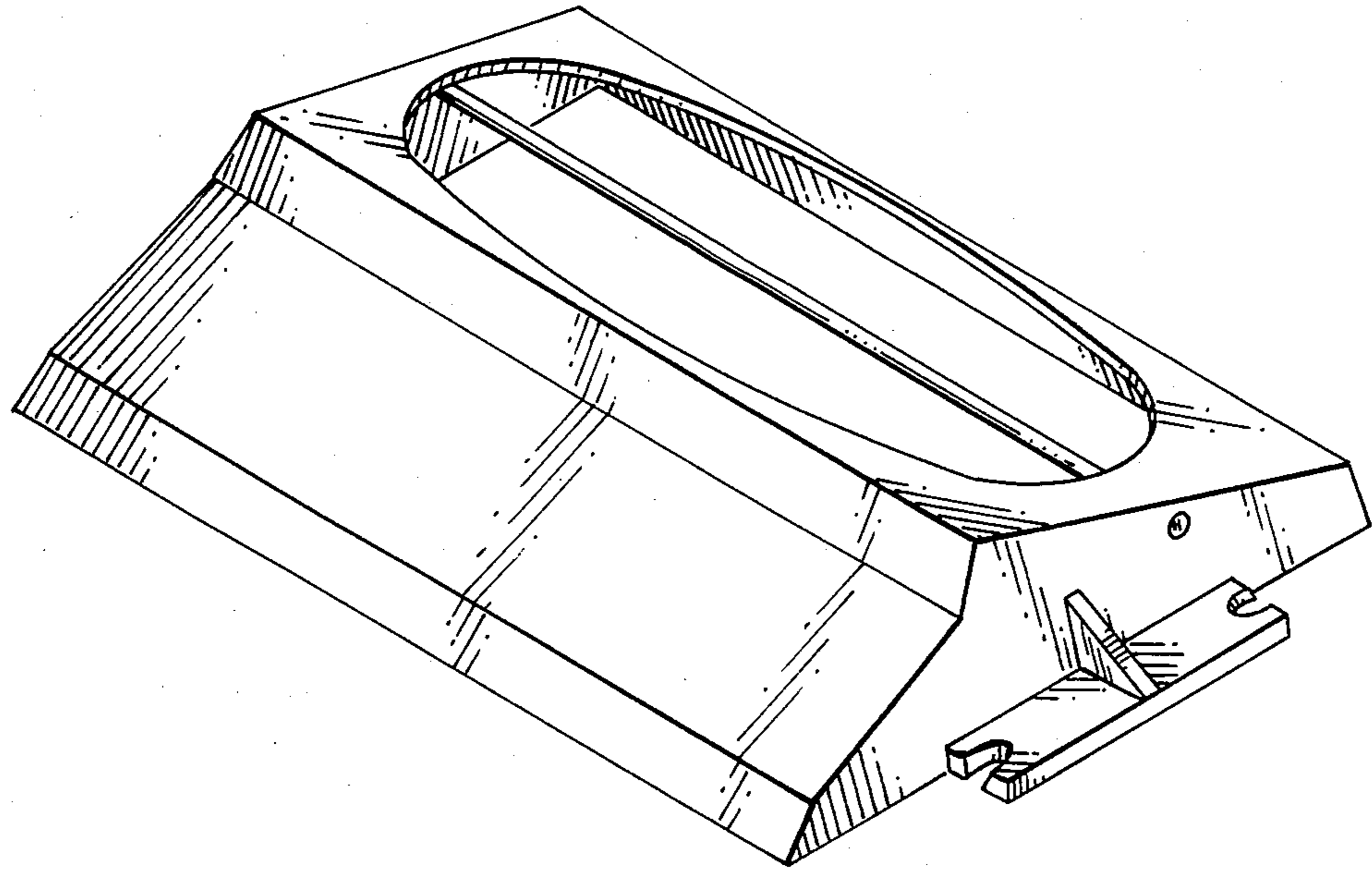

FIG. 7