

[54] PROTECTIVE SHIELD FOR TELEPHONE HANDSET

[76] Inventor: Keith R. Martens, 246 S. Weaver, Hesston, Kans. 67062

[**] Term: 14 Years

[21] Appl. No.: 83,093

[22] Filed: Aug. 10, 1987

[52] U.S. Cl. D14/250; D14/248

[58] Field of Search D14/52, 53, 4, 63, 65, D14/59, 67; 379/454, 455, 433, 440, 434, 428, 435, 436; 179/90 K; D21/111

[56] References Cited

U.S. PATENT DOCUMENTS

D. 81,475	7/1930	Bernhard	D14/63
D. 81,539	7/1930	Jensen	D14/63
D. 92,442	6/1934	Worthington	D14/53
D. 106,457	10/1937	Stehlik	D14/53
D. 138,951	9/1944	Midenz	D14/53
D. 151,614	11/1948	Dreyfuss	D14/63
D. 152,162	12/1948	Kniep, Jr.	D14/63
D. 174,098	2/1955	Robinson et al.	D14/63
D. 174,989	6/1955	Heller	D14/53

D. 210,953	5/1968	Youngberg	D14/59
D. 211,355	7/1968	Farnham et al.	D14/63 X
D. 218,978	10/1970	Abraham	D14/4
D. 226,612	4/1973	Robinson	D14/59
B 432,049	3/1976	Wilson	179/90 K X
4,546,217	10/1985	Frehn	D14/59 X
4,633,044	12/1986	Nakajima	379/433
4,759,058	7/1988	Sutton	379/455 X

Primary Examiner—Horace B. Fay, Jr.
Attorney, Agent, or Firm—Kokjer, Kircher, Bradley, Wharton, Bowman & Johnson

[57] CLAIM

The ornamental design for a protective shield for telephone handset, as shown and described.

DESCRIPTION

FIG. 1 is a perspective view of a protective shield for telephone handset showing my new design;
FIG. 2 is a side elevation view thereof;
FIG. 3 is a top plan view thereof,
FIG. 4 is an end elevational view thereof;
FIG. 5 is a elevational view from the opposite end thereof; and
FIG. 6 is a bottom plan view thereof.

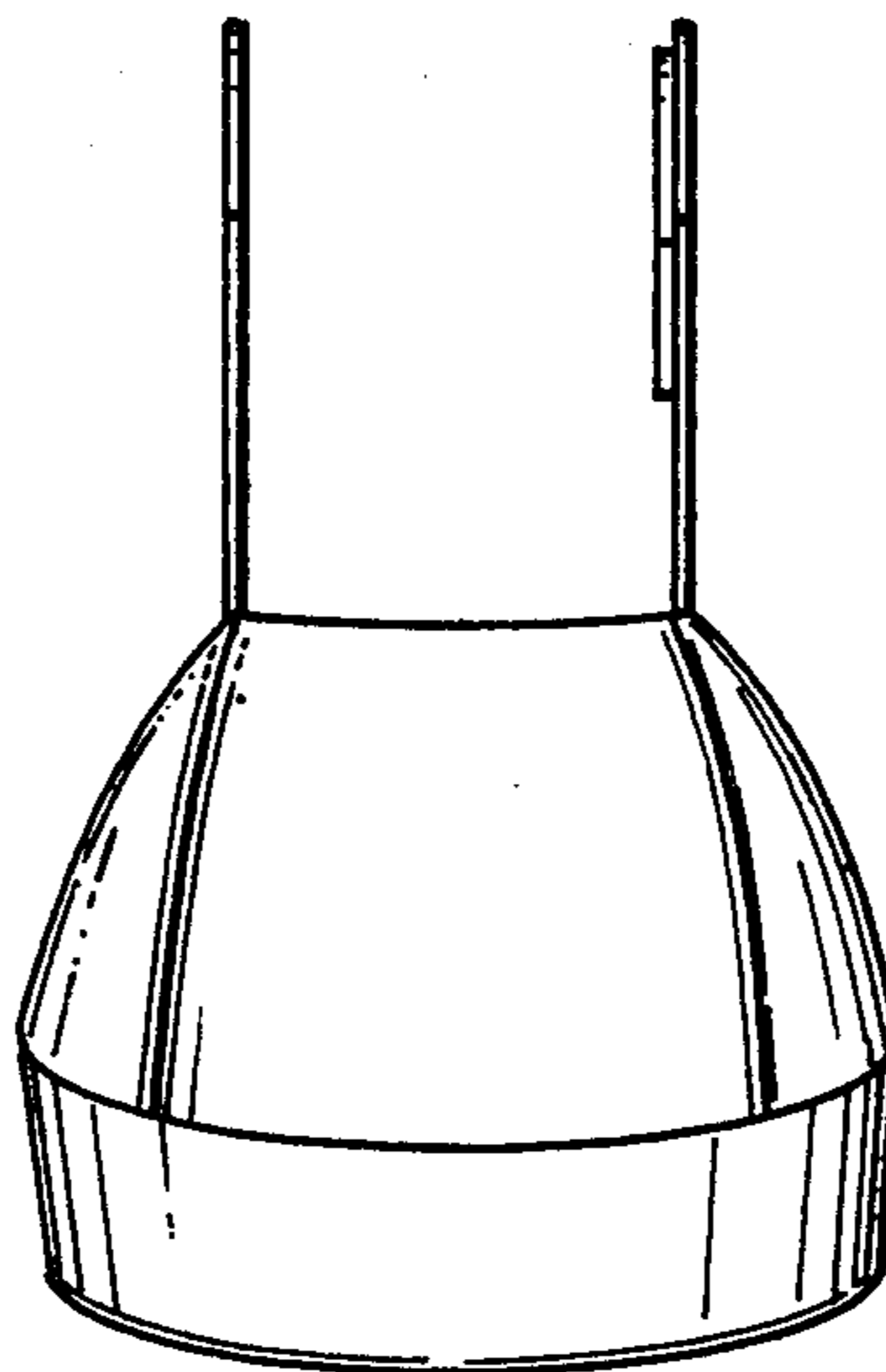
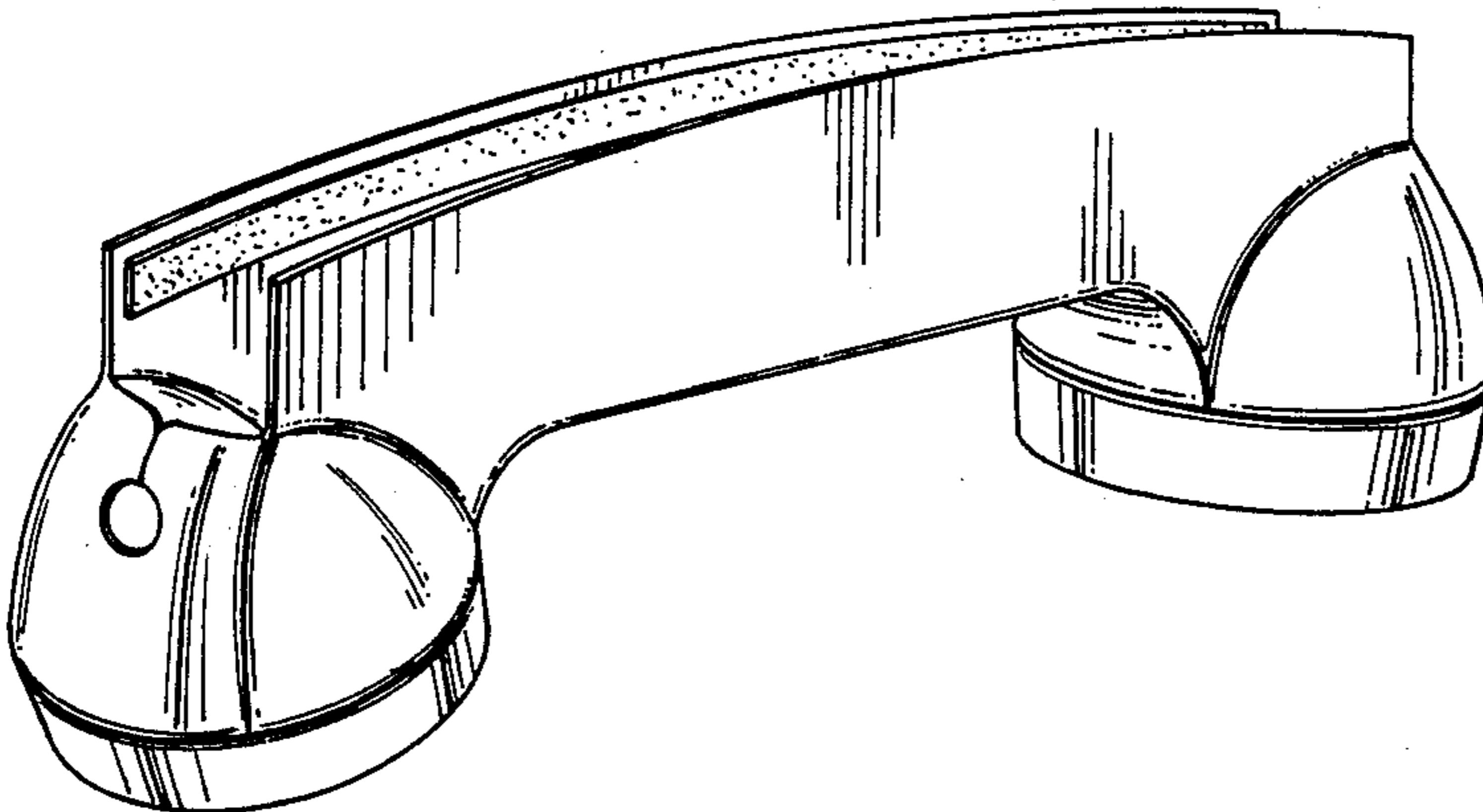

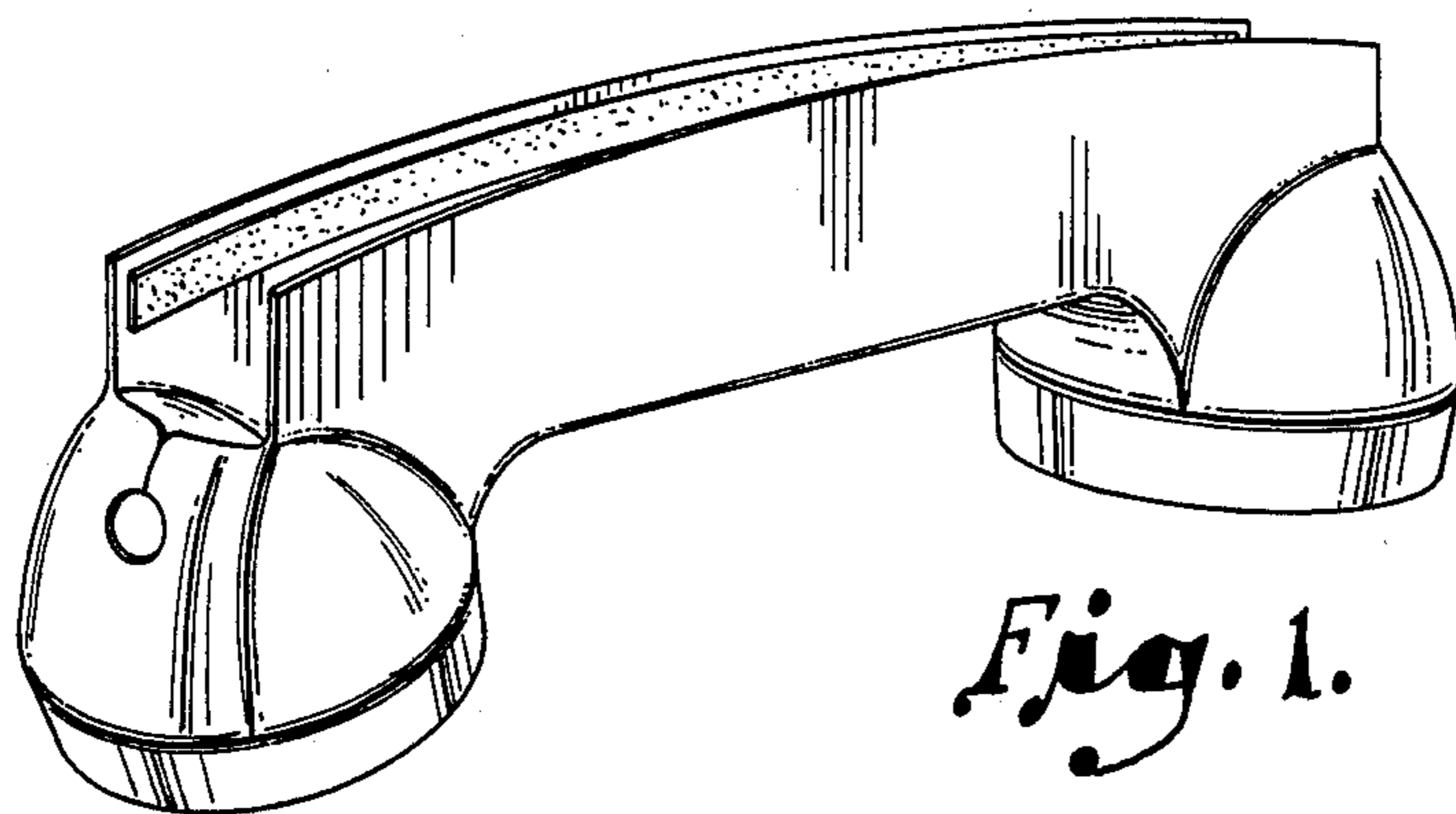

Fig. 1.

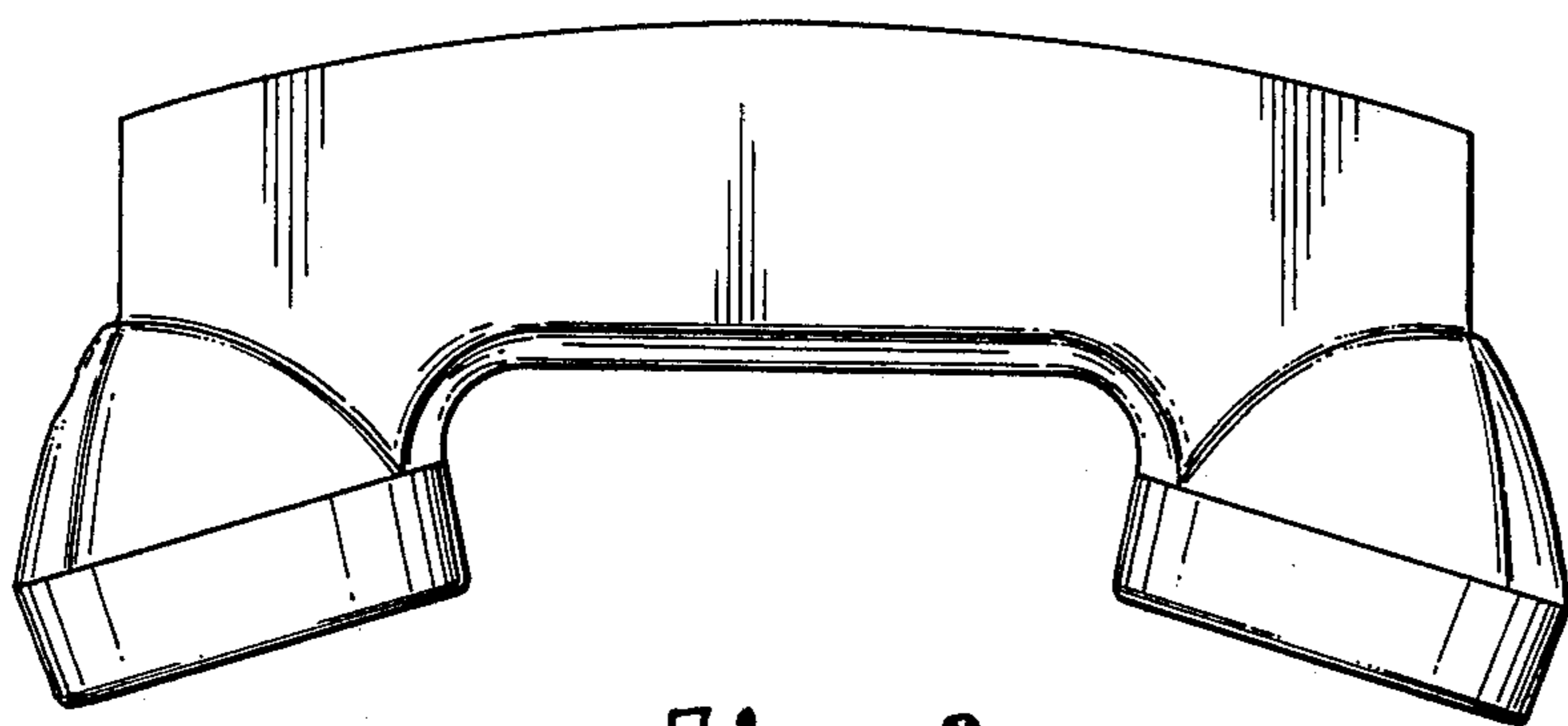

Fig. 2.

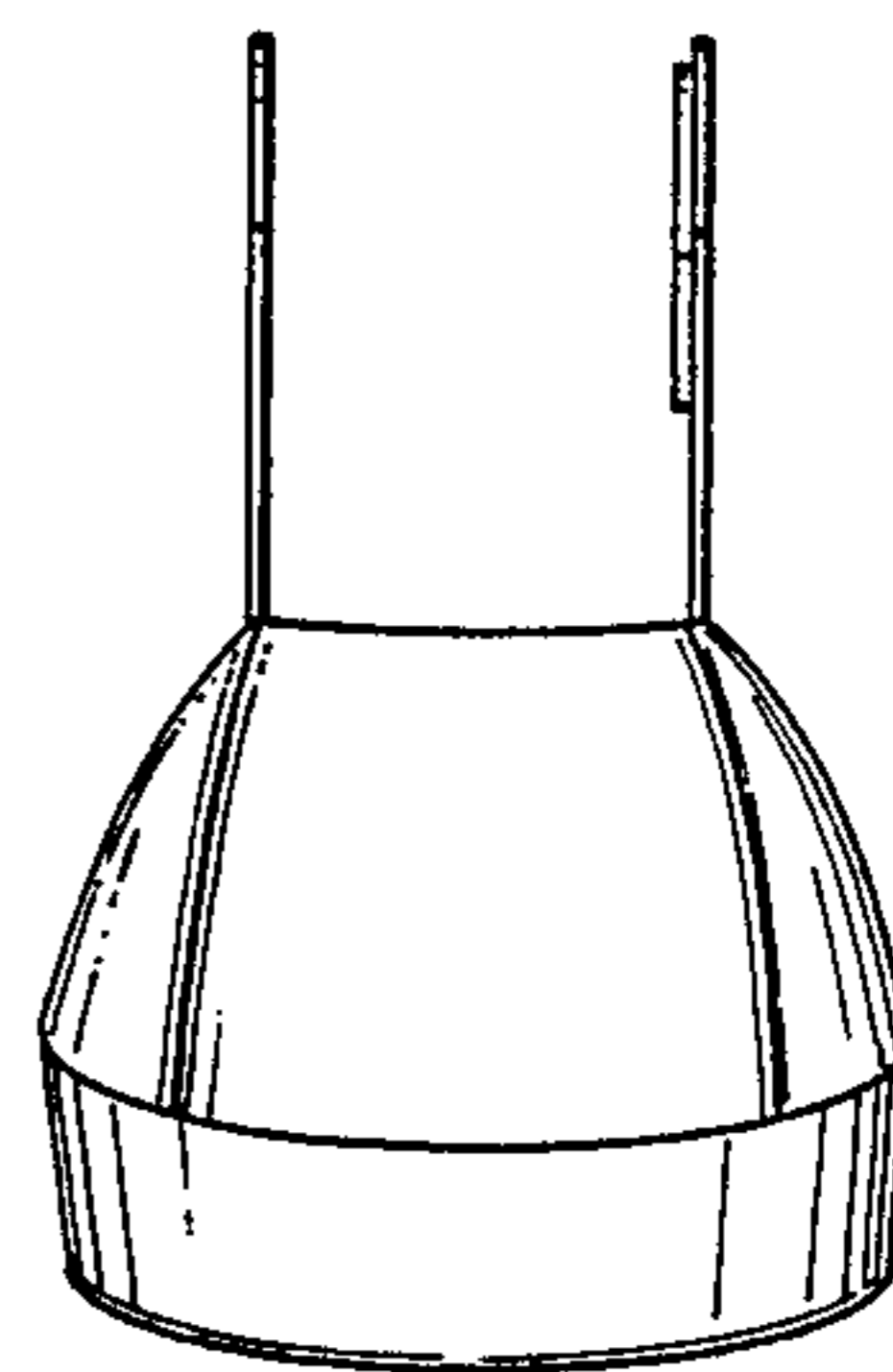

Fig. 4.

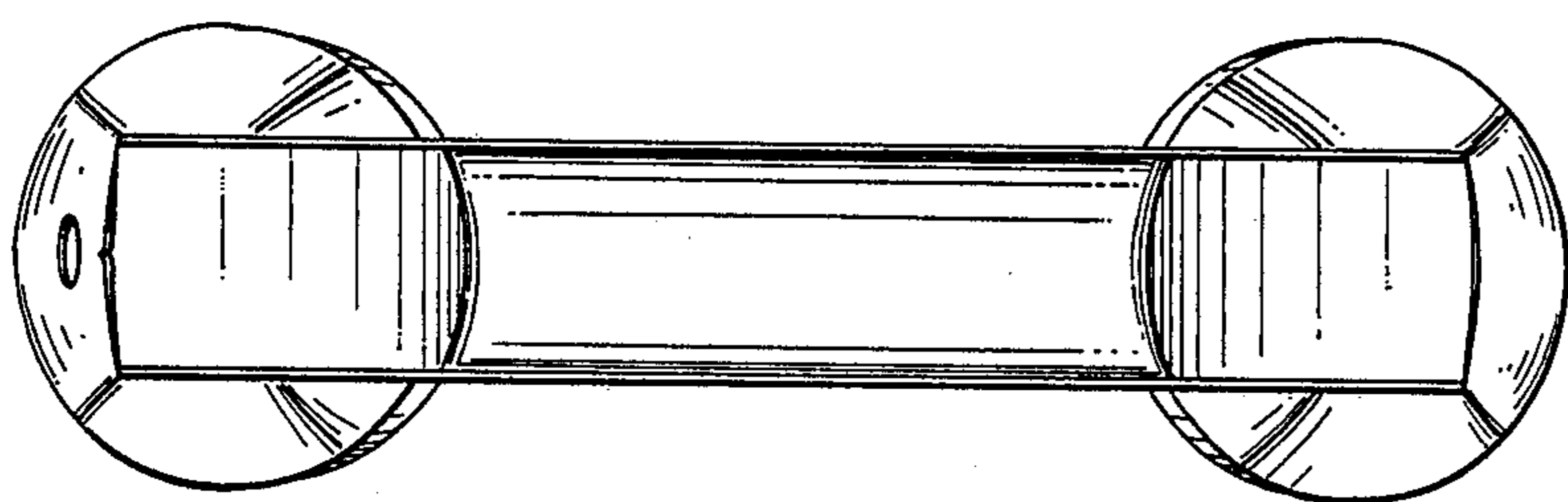

Fig. 3.

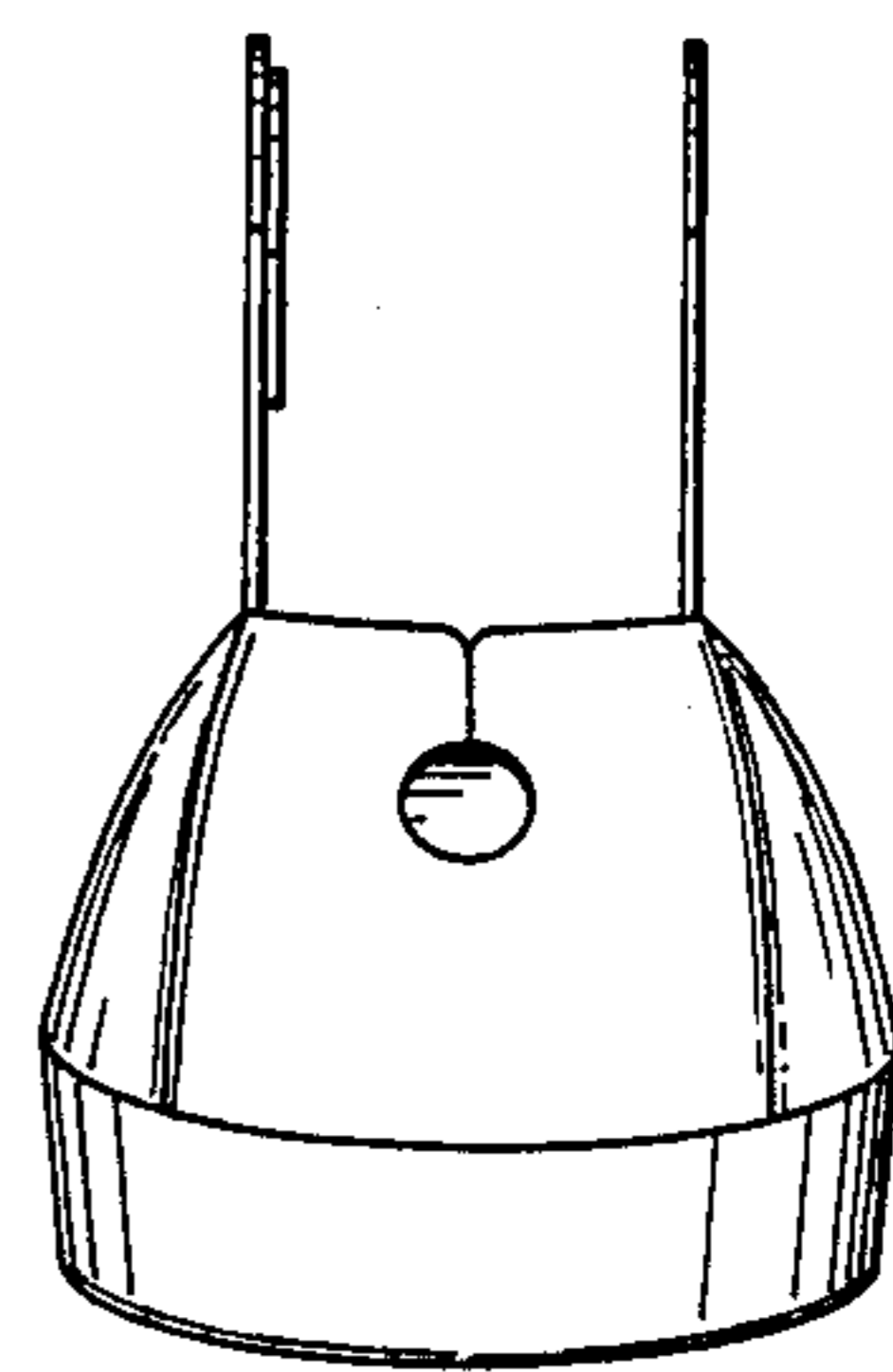

Fig. 5.

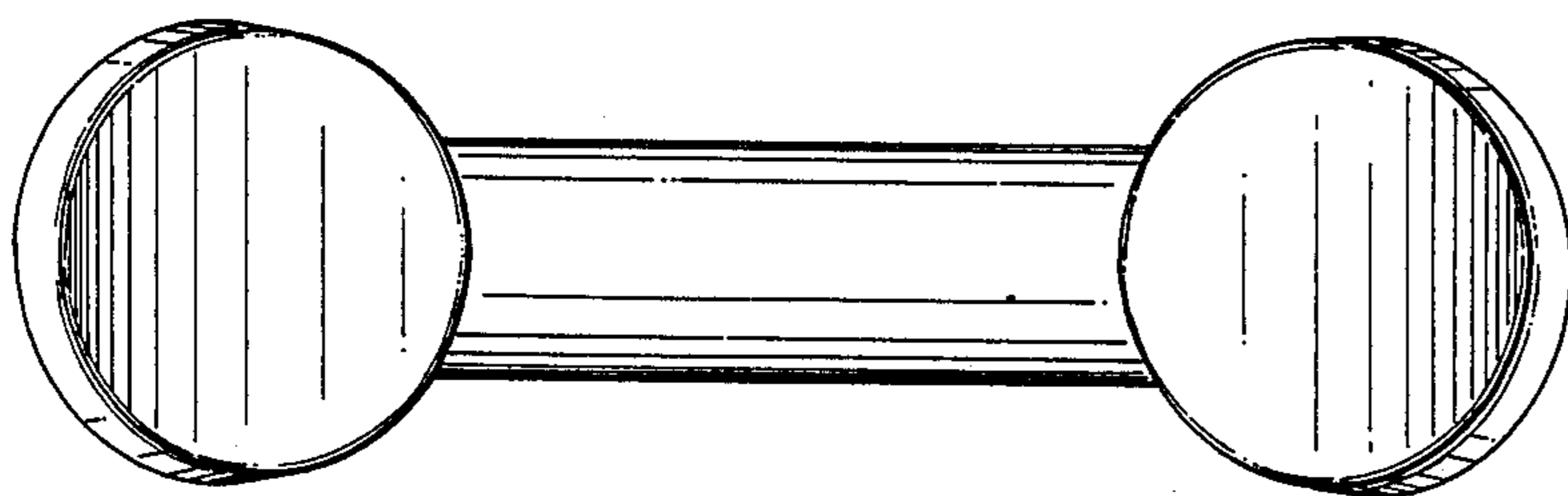

Fig. 6.