

United States Patent [19]
Ledenican

[11] **Patent Number: Des. 300,599**

[45] **Date of Patent: ** Apr. 11, 1989**

[54] **MASONRY GUIDE LINE HOLDER**

[75] **Inventor: Richard A. Ledenican, Alamosa, Colo.**

[73] **Assignee: Goldblatt Tool Co., Kansas City, Kans.**

[**] **Term: 14 Years**

[21] **Appl. No.: 827,360**

[22] **Filed: Feb. 7, 1986**

[52] **U.S. Cl. D8/71; D8/45; D10/70**

[58] **Field of Search D8/14, 45, 71-74, D8/360.1; 33/408, 409; D10/70**

[56] **References Cited**

U.S. PATENT DOCUMENTS

D. 183,406 8/1958 Power D8/71

D. 214,985 8/1969 Davis D8/45
2,208,085 7/1940 Sabiston 33/408
3,555,688 1/1971 Smathers 33/408

Primary Examiner—Bruce W. Dunkins
Assistant Examiner—Clare E. Heflin
Attorney, Agent, or Firm—Kirkland & Ellis

[57] **CLAIM**

The ornamental design for a masonry guide line holder, as shown and described.

DESCRIPTION

FIG. 1 is a perspective view of a masonry guide line holder showing my new design;
FIG. 2 is a top plan view thereof;
FIG. 3 is a front elevational view thereof;
FIG. 4 is a bottom plan view thereof;
FIG. 5 is a left side elevational view thereof the right side being a mirror image; and
FIG. 6 is a rear elevational view thereof.

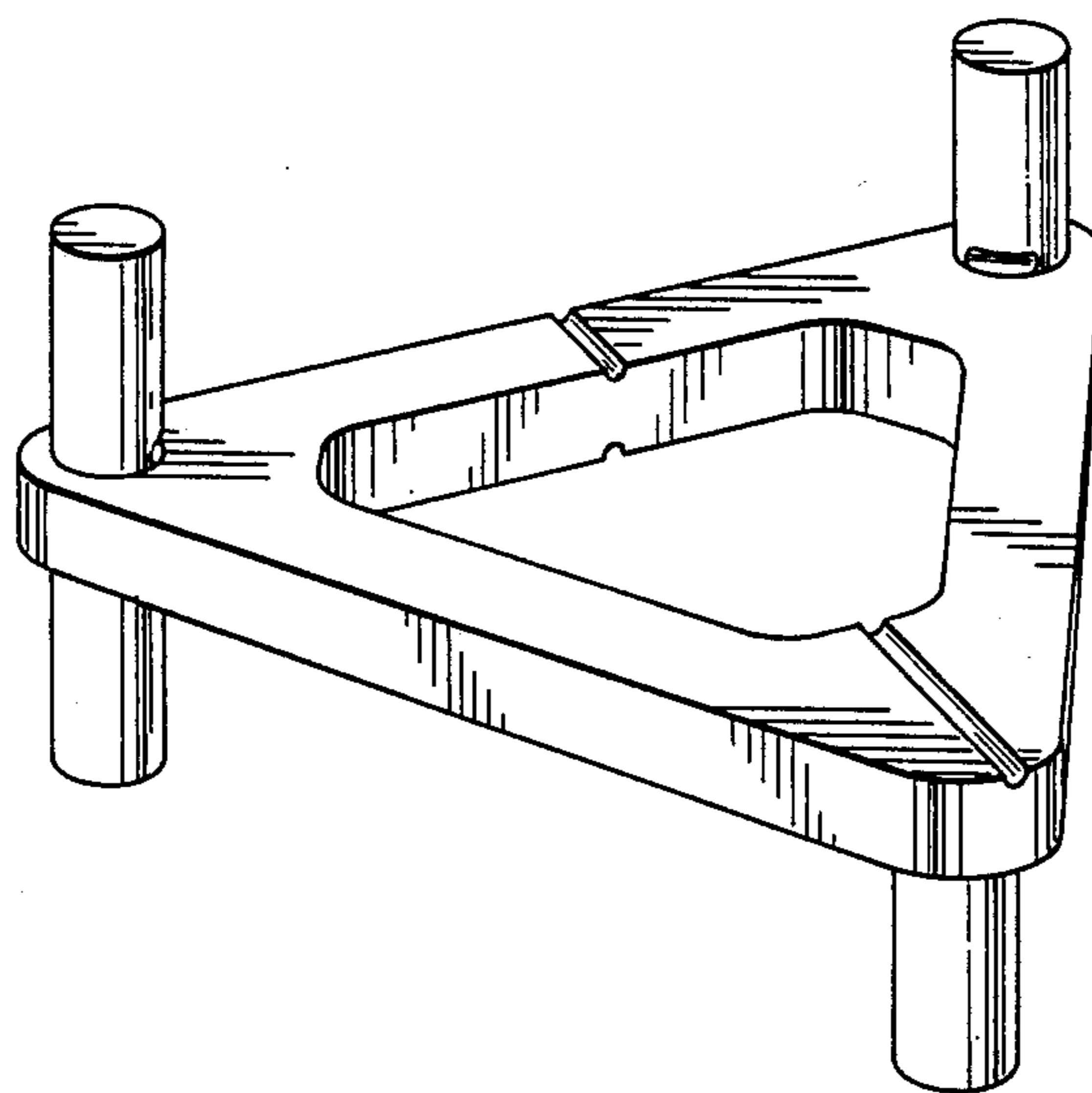

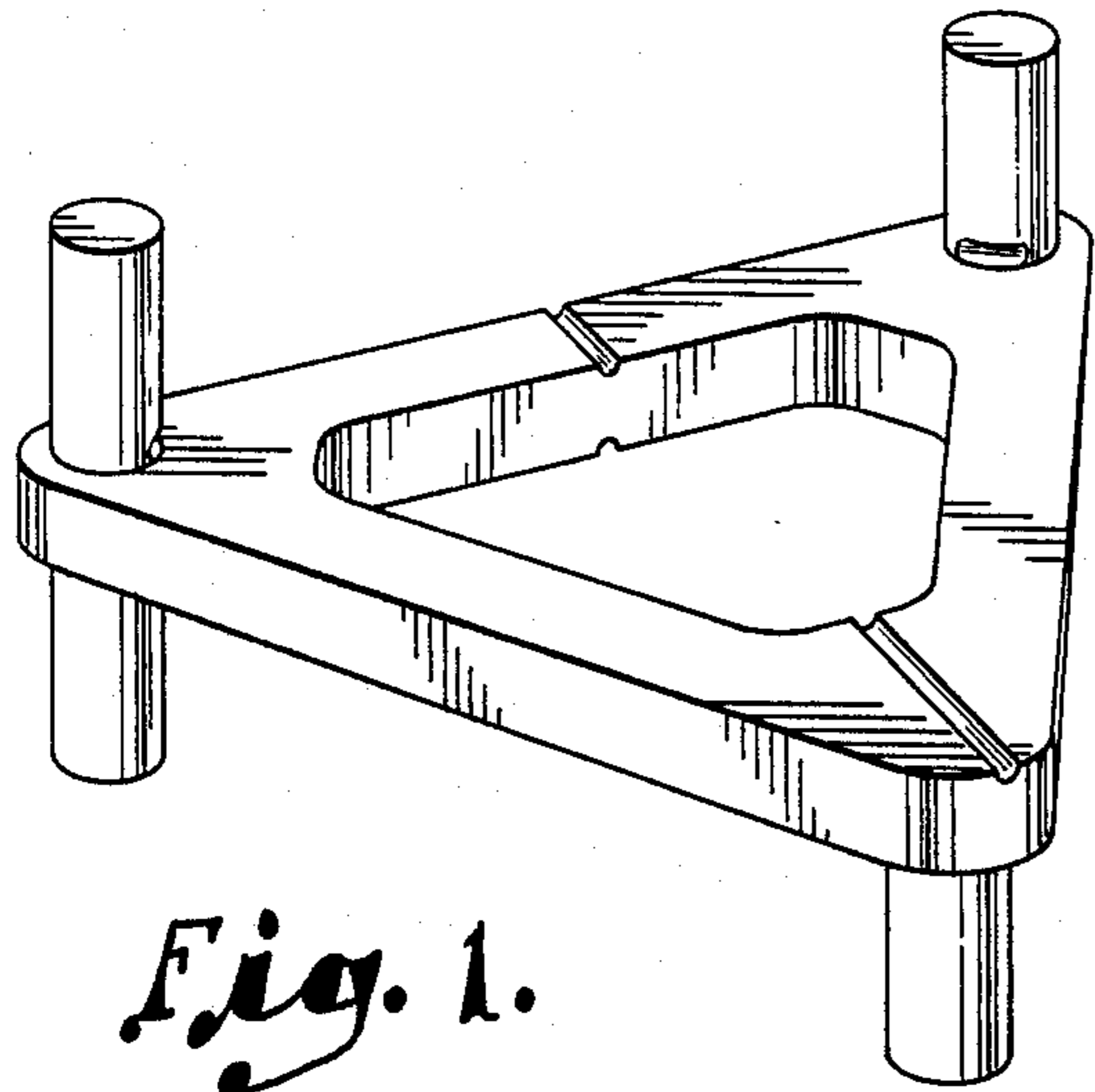

Fig. 1.

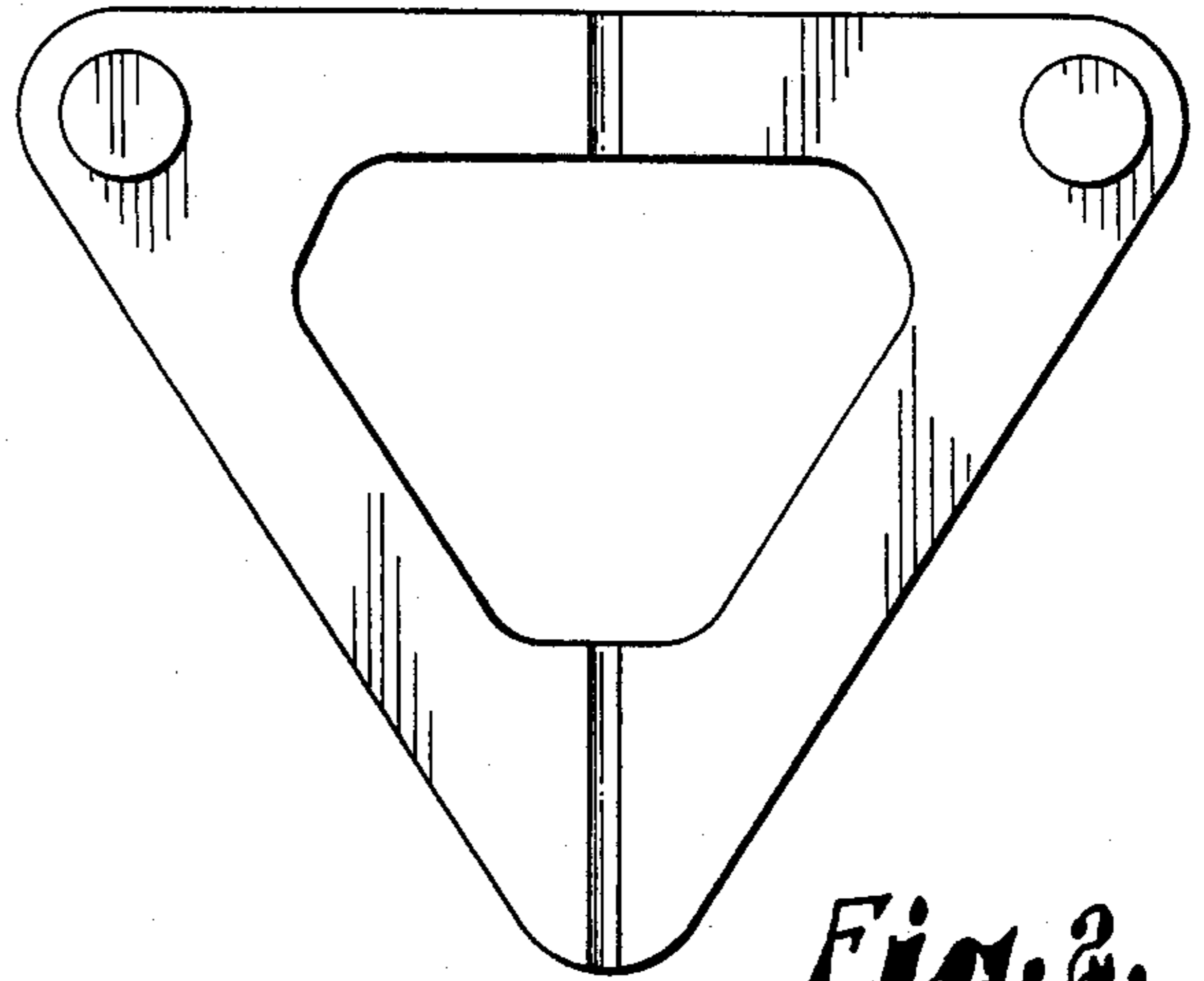

Fig. 2.

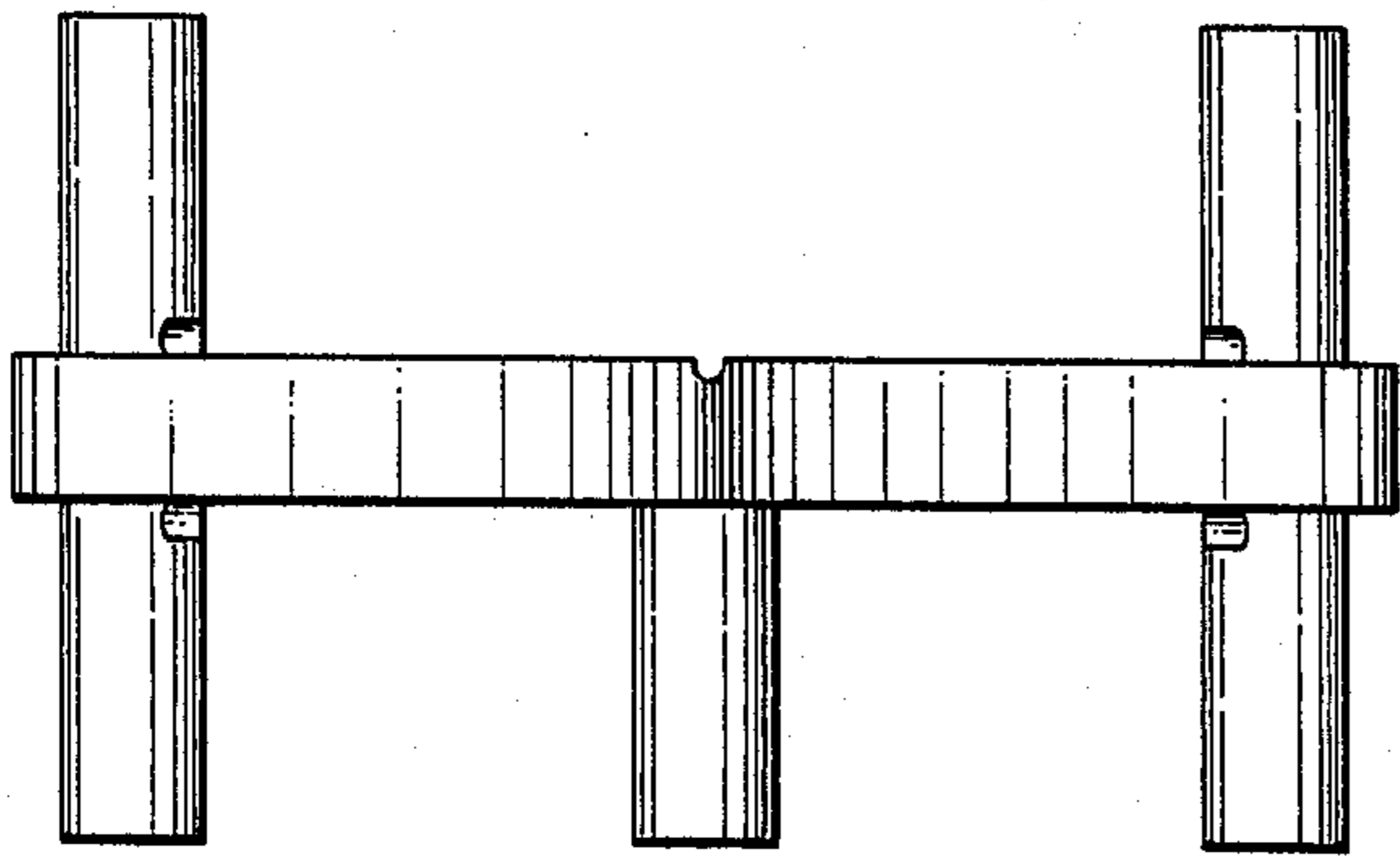

Fig. 3.

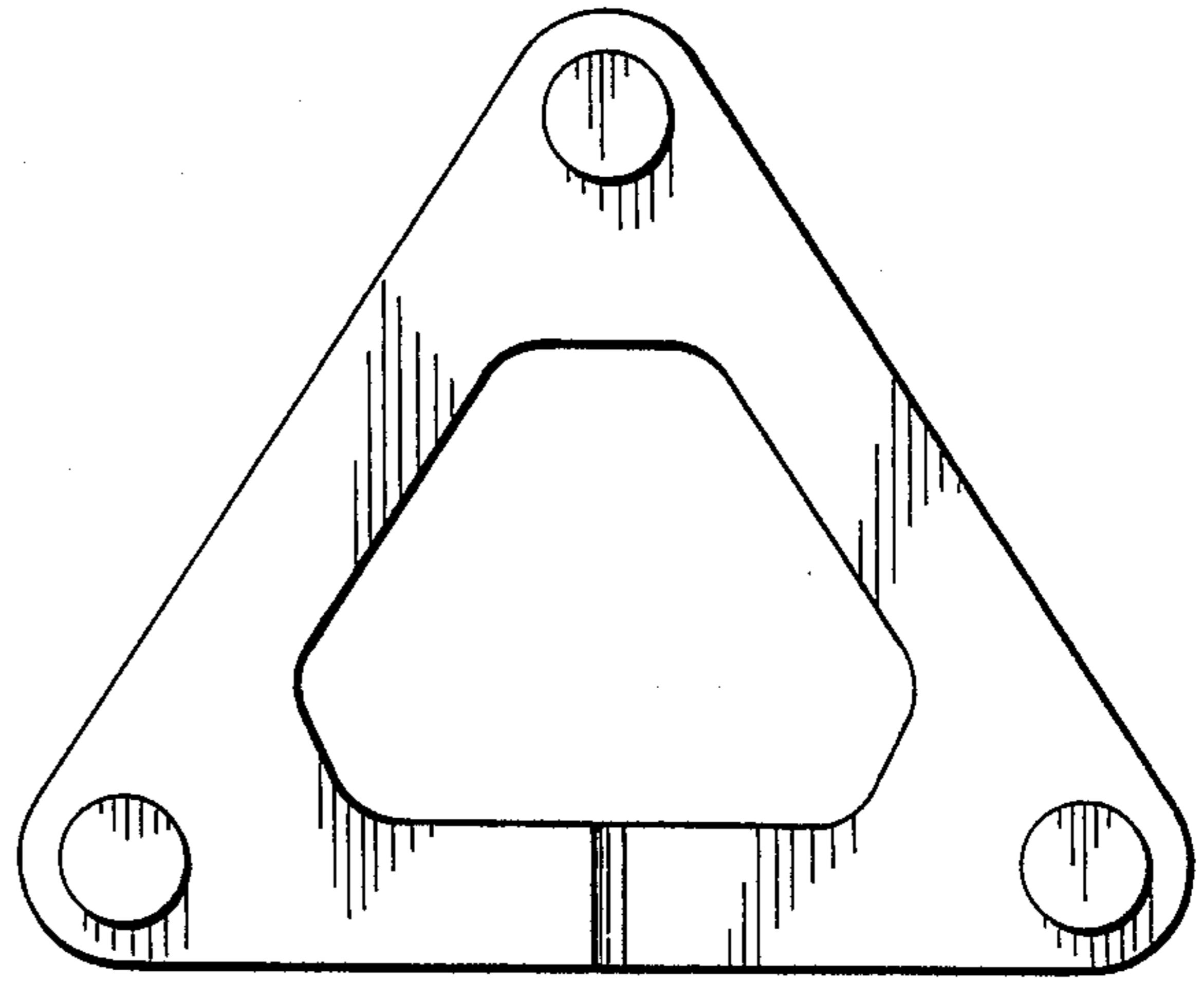

Fig. 4.

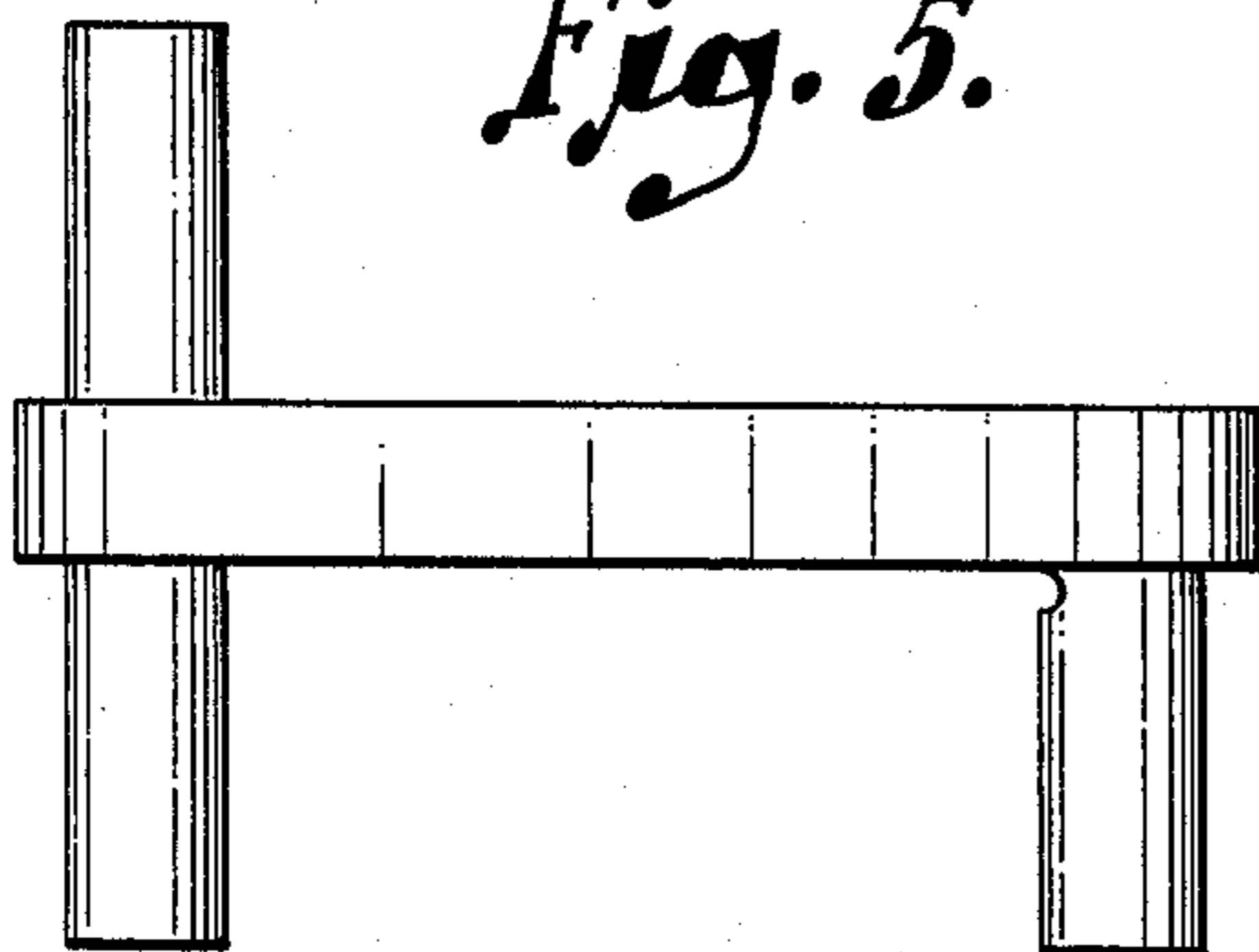

Fig. 5.

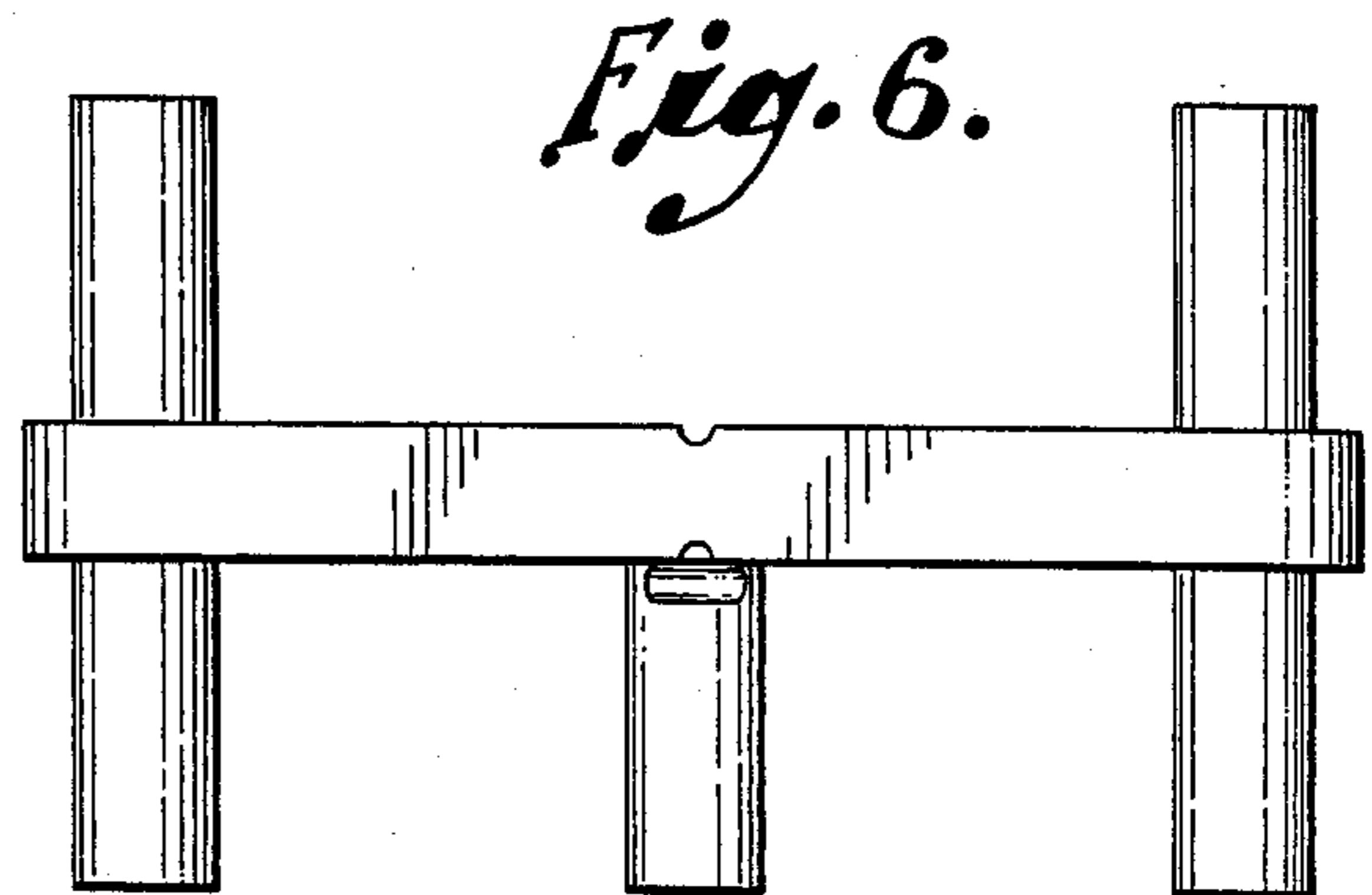

Fig. 6.