

[54] **CHAIR**

[75] **Inventor:** Winsor White, Chicago, Ill.

[73] **Assignee:** Vecta Contract Division of Steelcase Inc., Grand Prairie, Tex.

[\*\*] **Term:** 14 Years

[21] **Appl. No.:** 898,627

[22] **Filed:** Aug. 21, 1986

[52] **U.S. Cl. .... D6/379**

[58] **Field of Search ..... D6/334, 372, 373, 375, D6/379, 380**

[56] **References Cited**

**U.S. PATENT DOCUMENTS**

- D. 278,105 3/1985 Ridenour ..... D6/379
- D. 278,393 4/1985 Platner ..... D6/374
- D. 285,753 9/1986 Zola ..... D6/373
- D. 289,348 4/1987 Snodgrass ..... D6/373

**OTHER PUBLICATIONS**

Office Products Dealer, Jul. 1981, p. 117, Chair, left center of page.

*Primary Examiner*—Bruce W. Dunkins  
*Assistant Examiner*—A. S. Hunt

[57] **CLAIM**

The ornamental design for a chair, as shown and described.

**DESCRIPTION**

FIG. 1 is a front perspective view of a chair showing my new design;

FIG. 2 is a side elevational view of the chair incorporating the new design with the opposite side being identical;

FIG. 3 is a front elevational view of the chair incorporating the new design;

FIG. 4 is a rear elevational view of the chair embodying the new design.

FIG. 5 is a front perspective view of a chair showing a modified form of my design;

FIG. 6 is a side elevational view of the modified chair of FIG. 5;

FIG. 7 is a front elevational view of the modified chair of FIG. 5; and

FIG. 8 is a rear elevational view of the modified chair of FIG. 5.

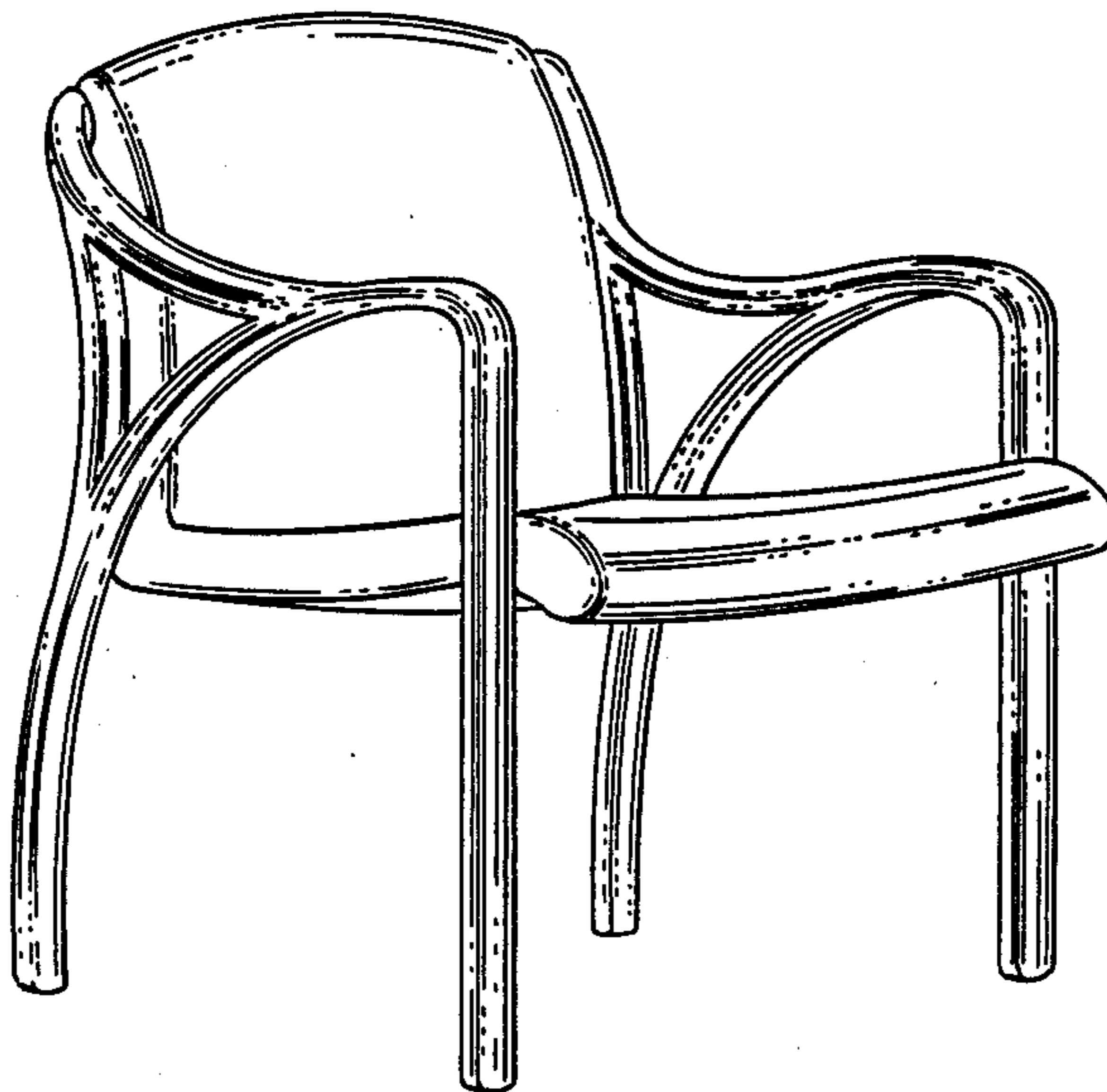

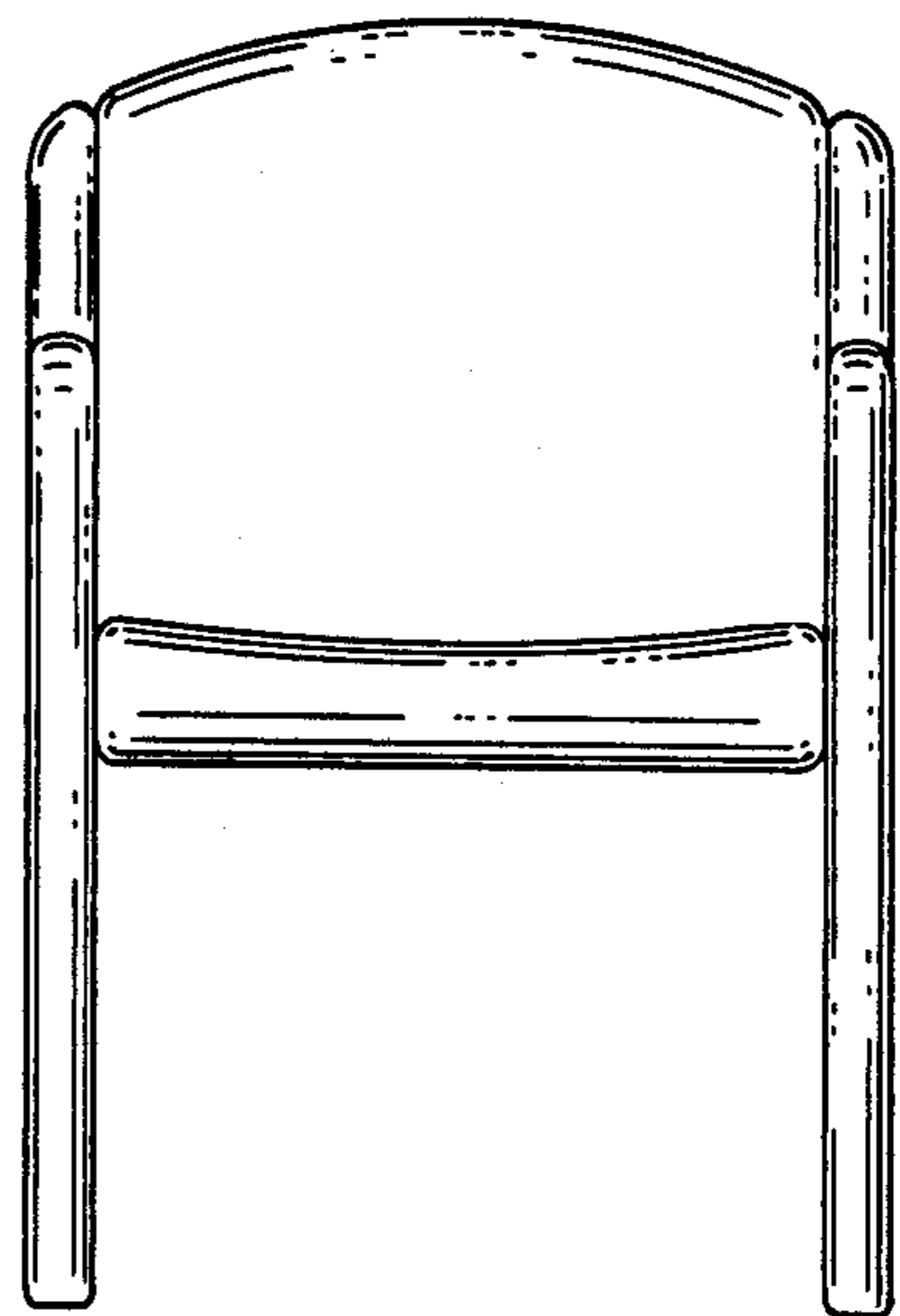
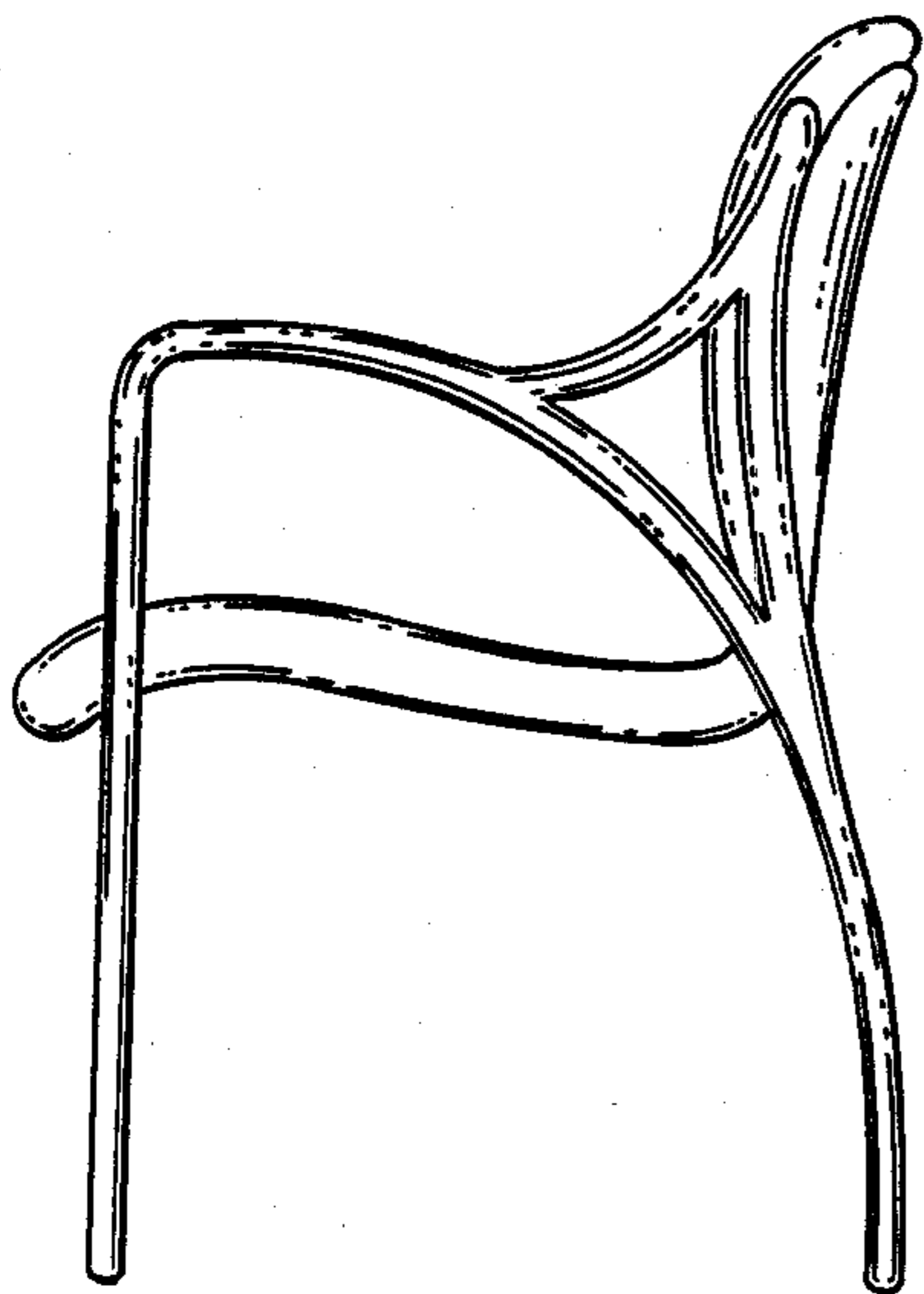
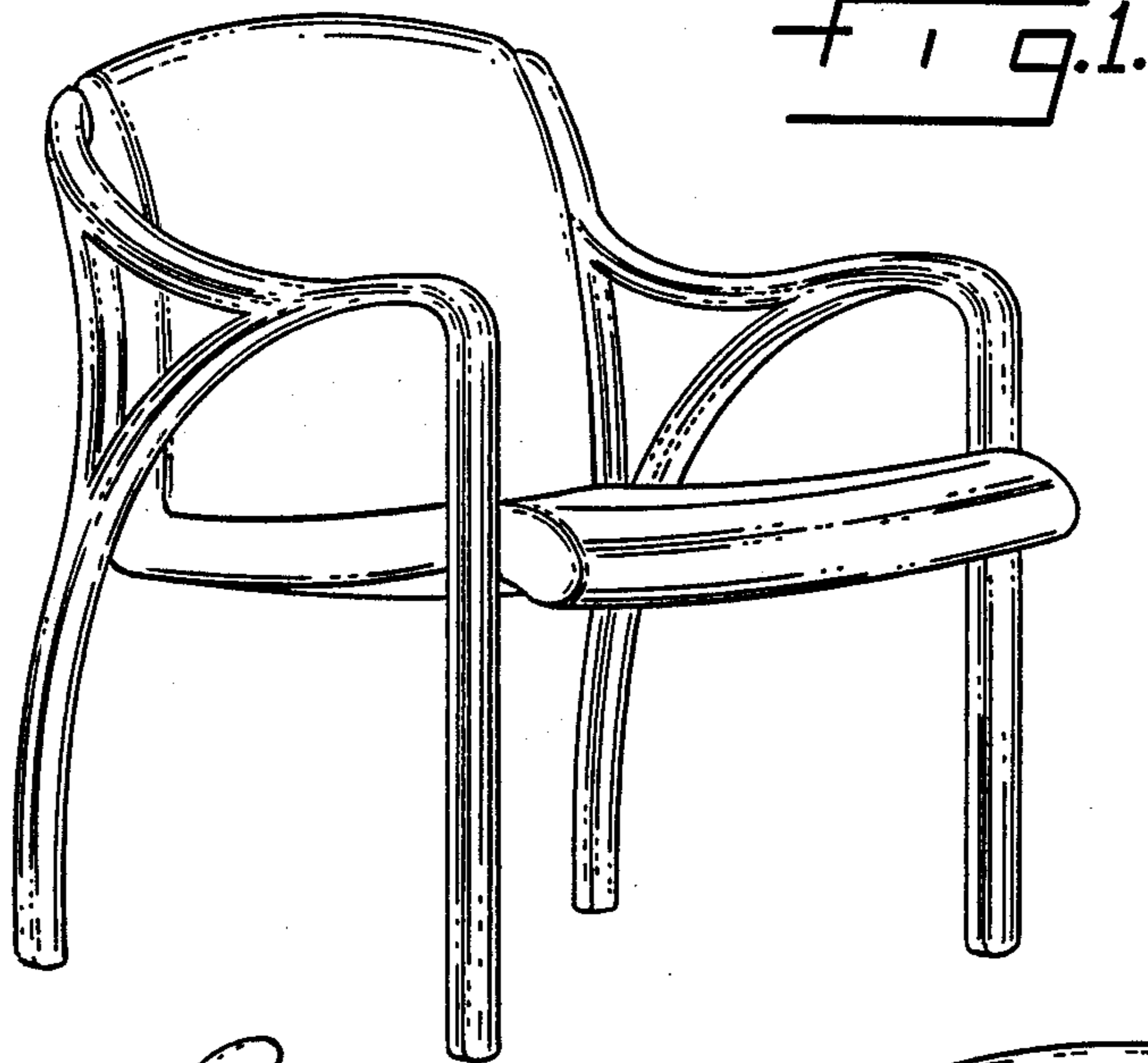
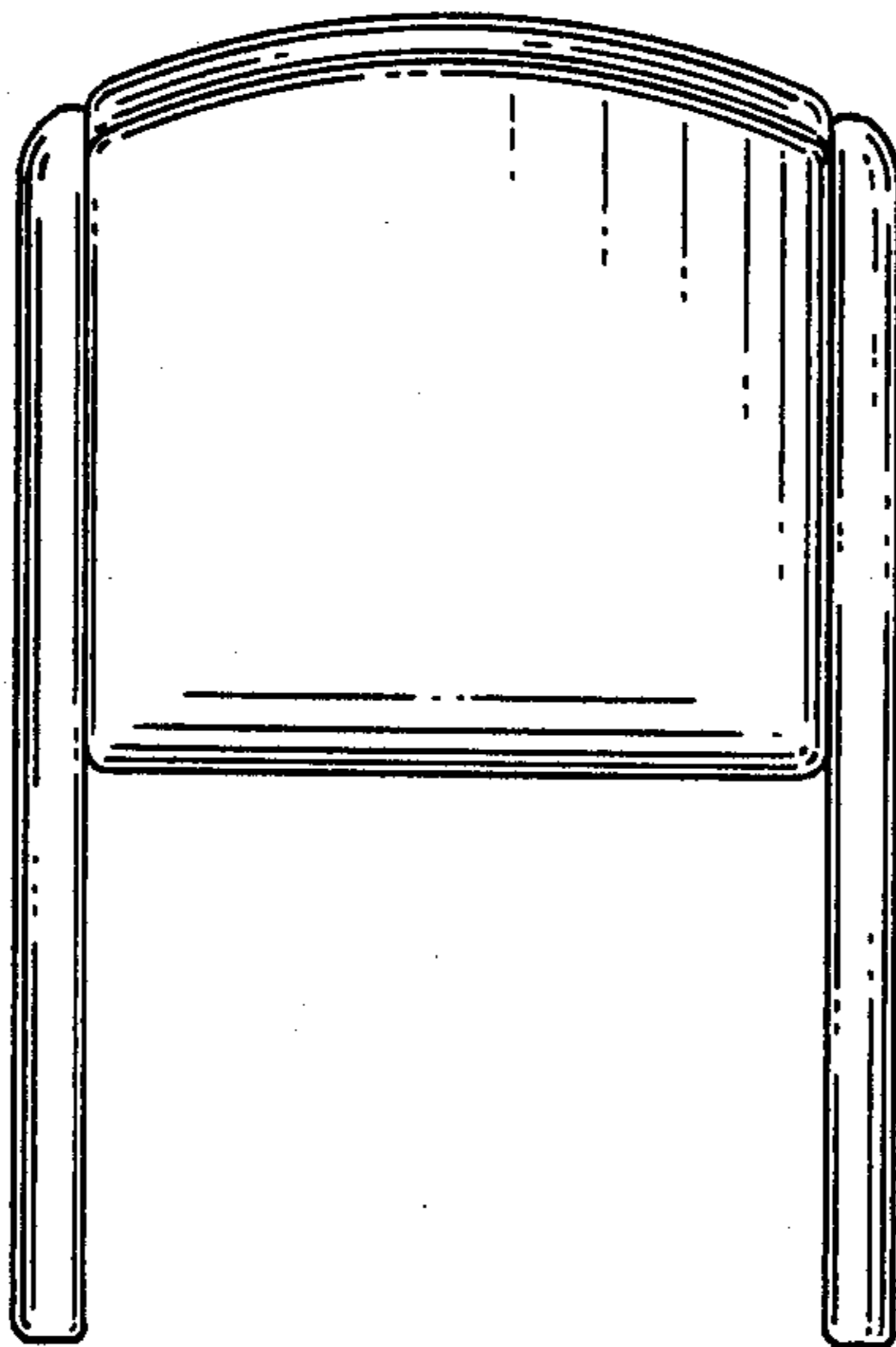

FIG. 2.

FIG. 3.

FIG. 4.



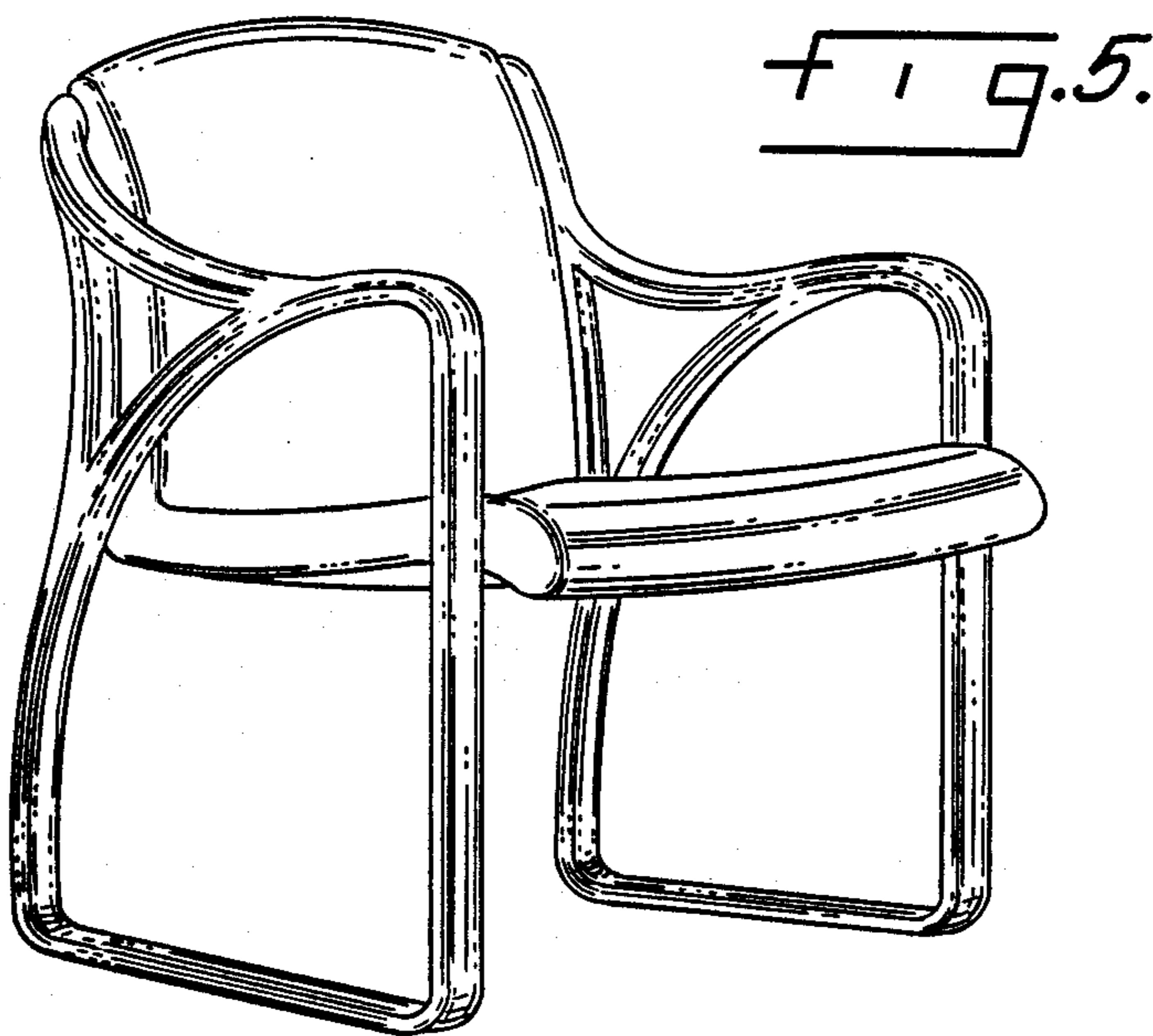

FIG. 5.

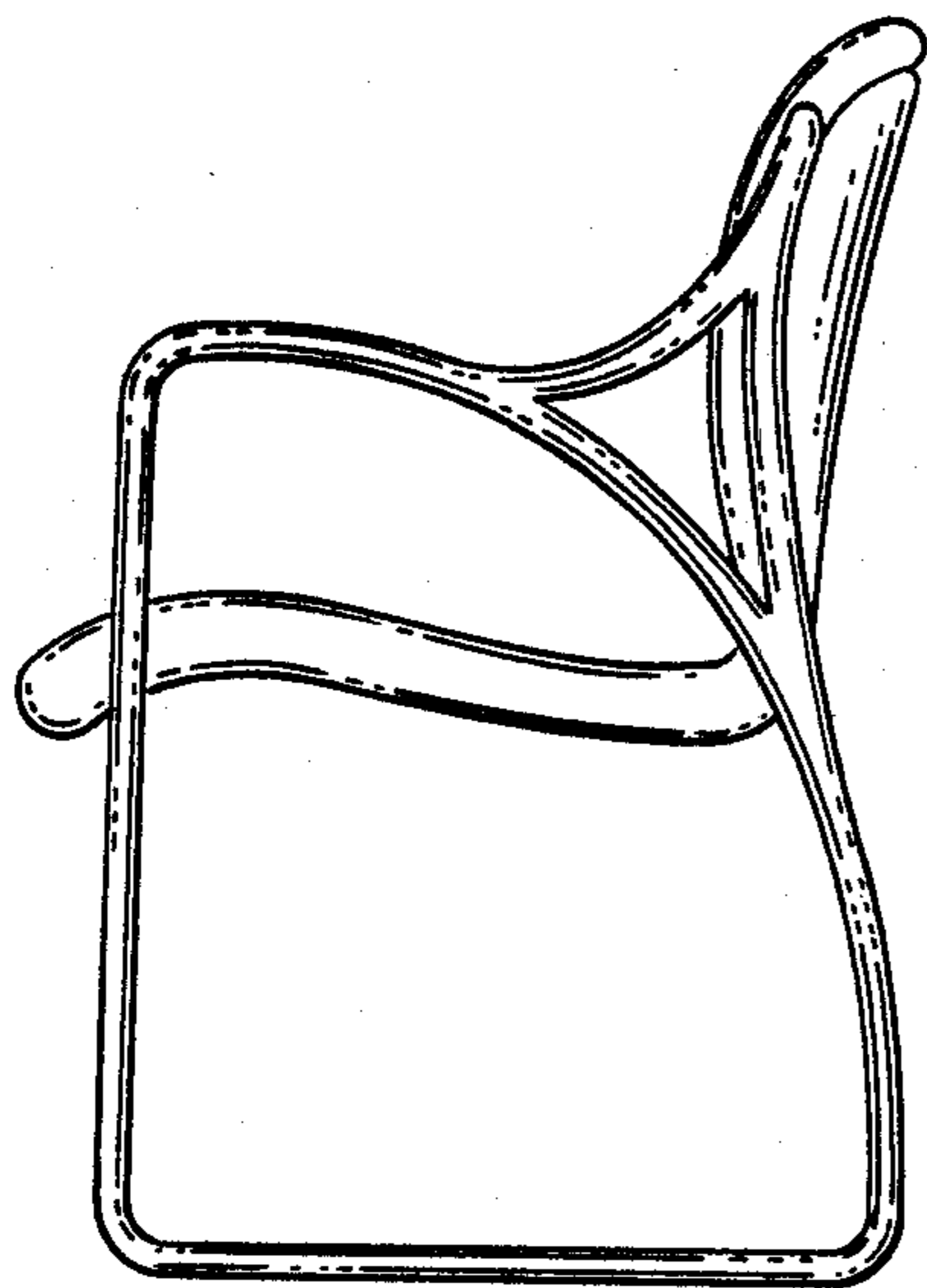

FIG. 6.

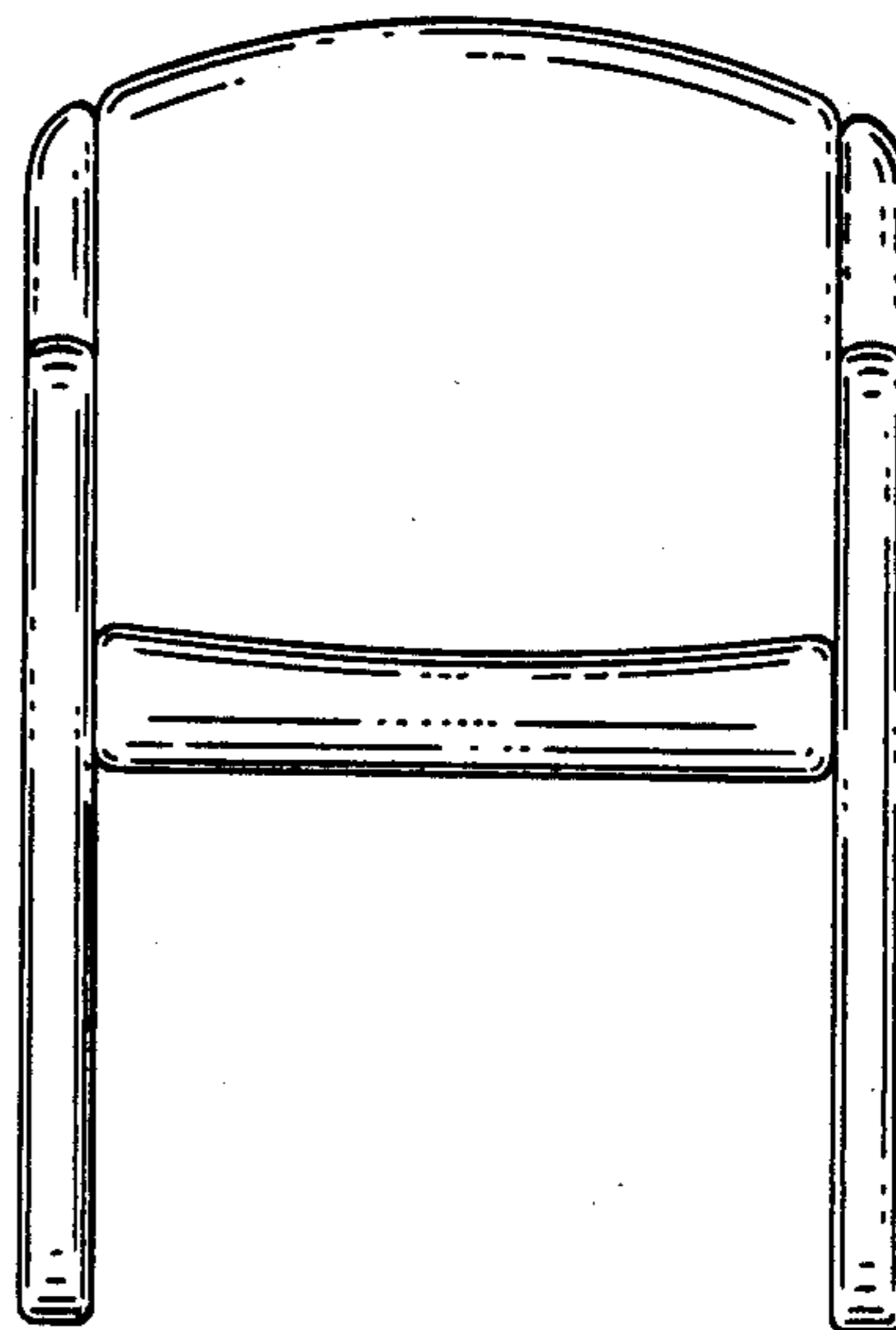

FIG. 7.

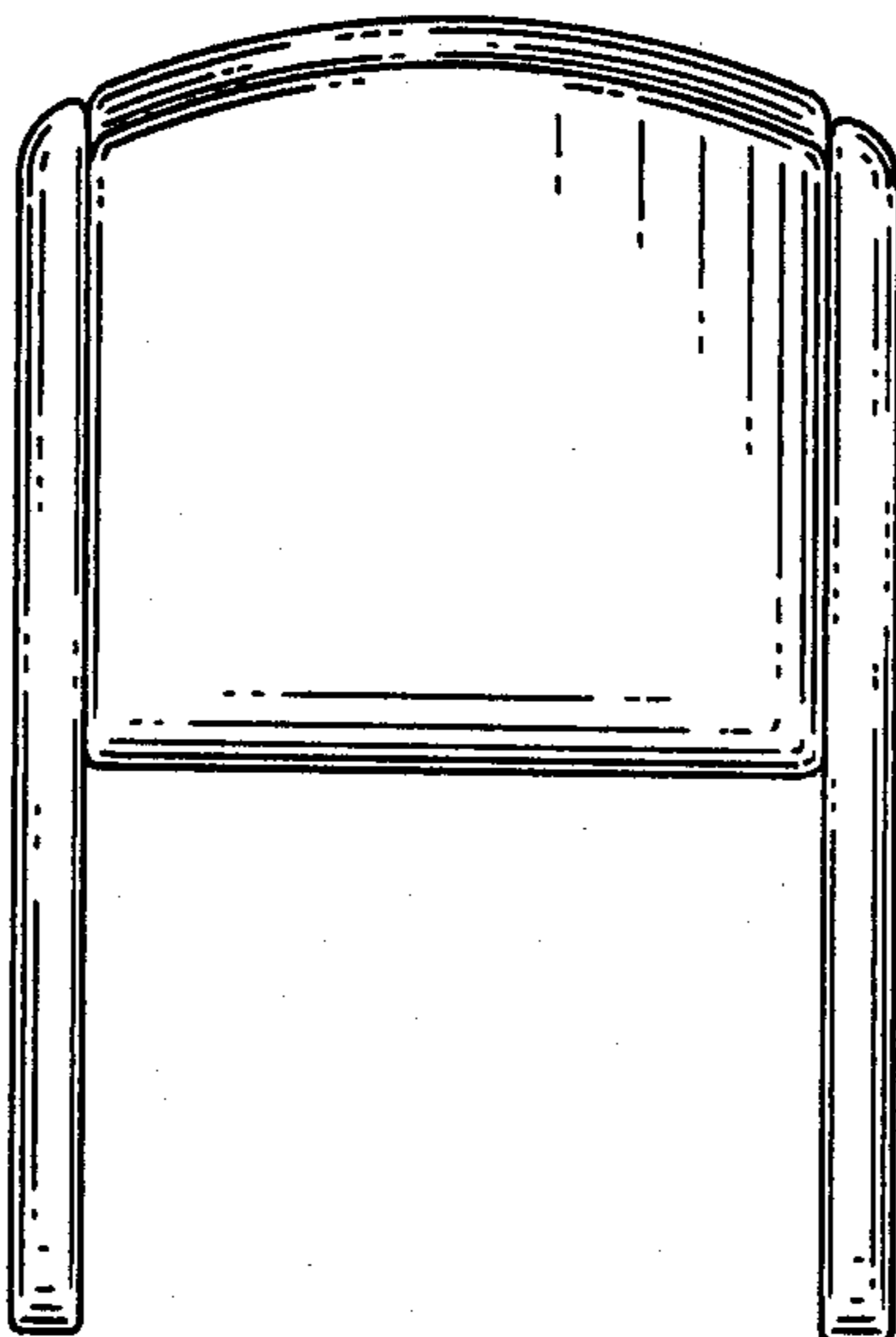

FIG. 8.