

[54] GOLF CLUB HEAD

[76] Inventor: David Boone, 4633 Wingate St., Oceanside, Calif. 92054

[**] Term: 14 Years

[21] Appl. No.: 747,812

[22] Filed: Jun. 21, 1985

[52] U.S. Cl. D21/220

[58] Field of Search D21/214-220; 273/167-175

[56] References Cited

U.S. PATENT DOCUMENTS

4,345,763 8/1982 Swanson 273/164

OTHER PUBLICATIONS

Golf Digest, Mar. 1978, p. 14, upper left, Club House Iron.

Primary Examiner—Melvin B. Feifer
Attorney, Agent, or Firm—Leonard Tachner

[57] CLAIM

The ornamental design for a golf club head, as shown and described.

DESCRIPTION

FIG. 1 is a perspective view of a golf club head showing my new design;
FIG. 2 is an end view taken from the right of FIG. 1;
FIG. 3 is an end view taken from the left of FIG. 1.
FIG. 4 is a front view thereof;
FIG. 5 is a rear view thereof;
FIG. 6 is a top view thereof; and
FIG. 7 is a bottom view thereof.
FIGS. 8 and 9 are cross-sectional views thereof taken along lines 8—8 and 9—9, respectively, of FIG. 5.
The broken line showing a shaft portion is for illustrative purposes only.

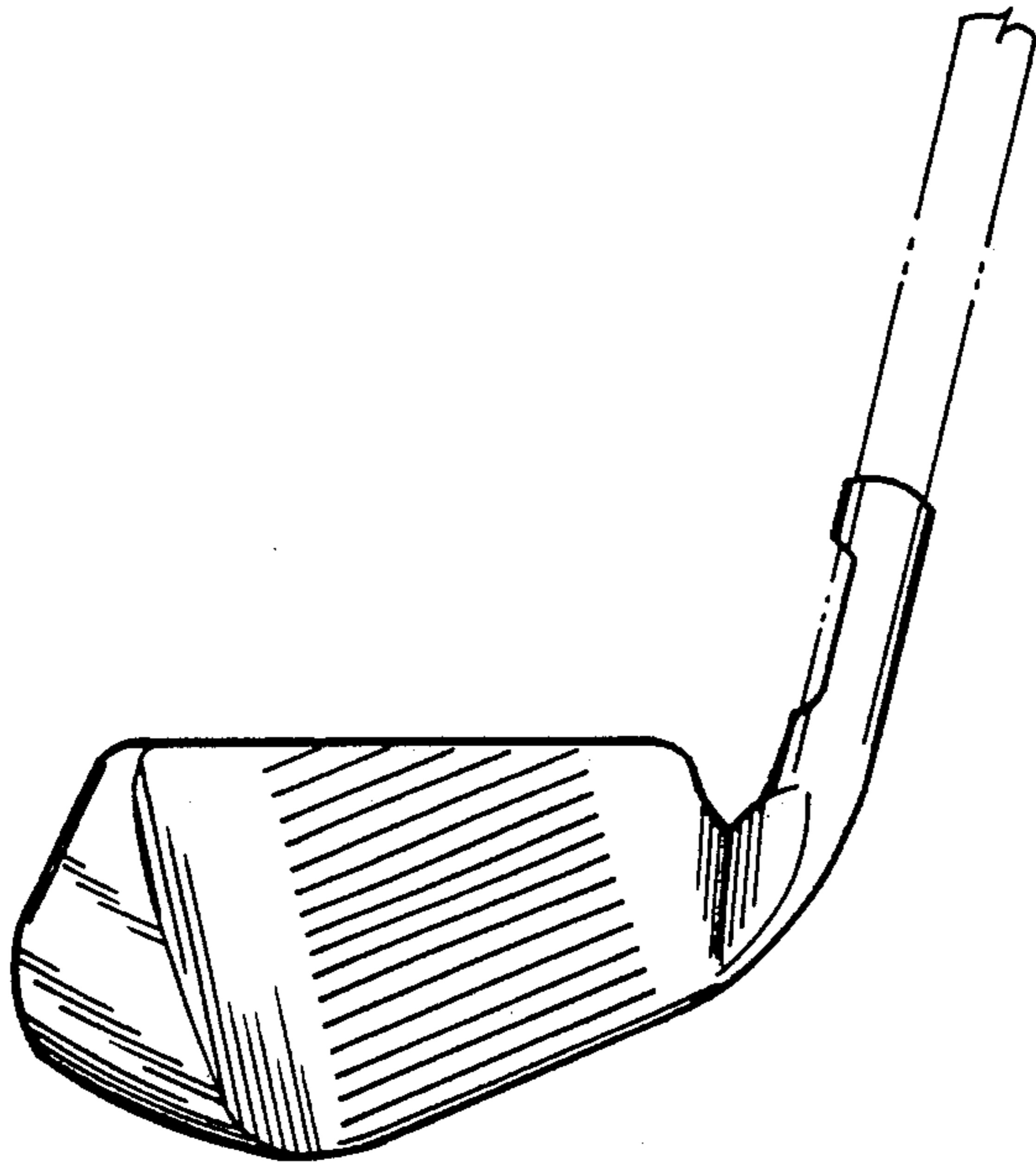

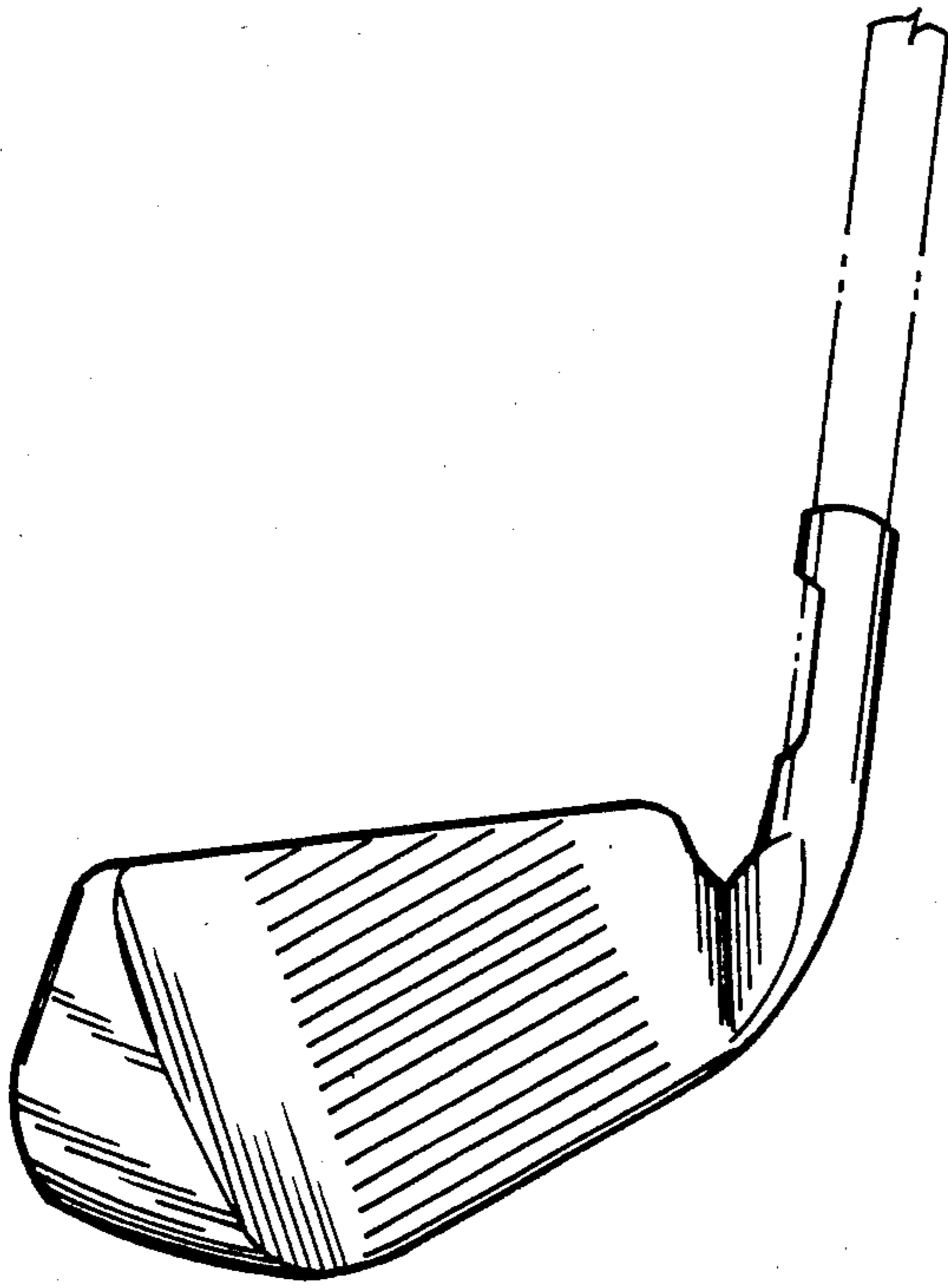

FIG. 1

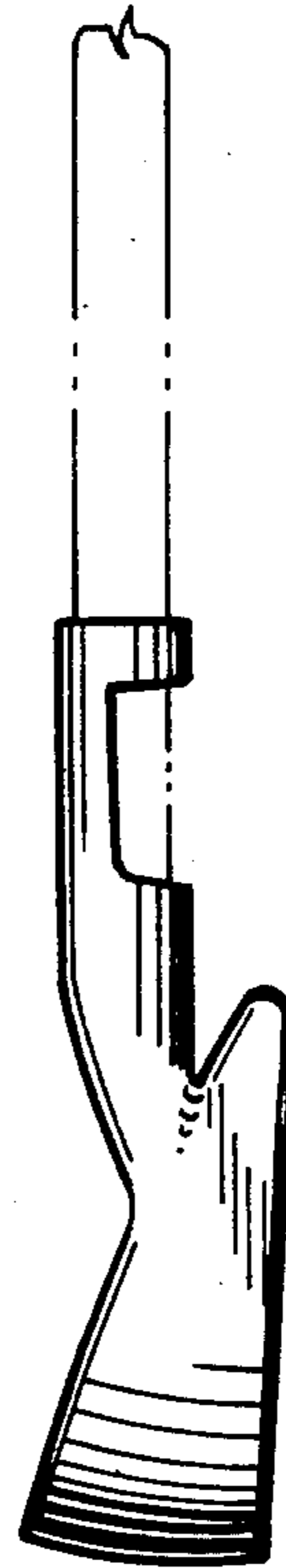

FIG. 2

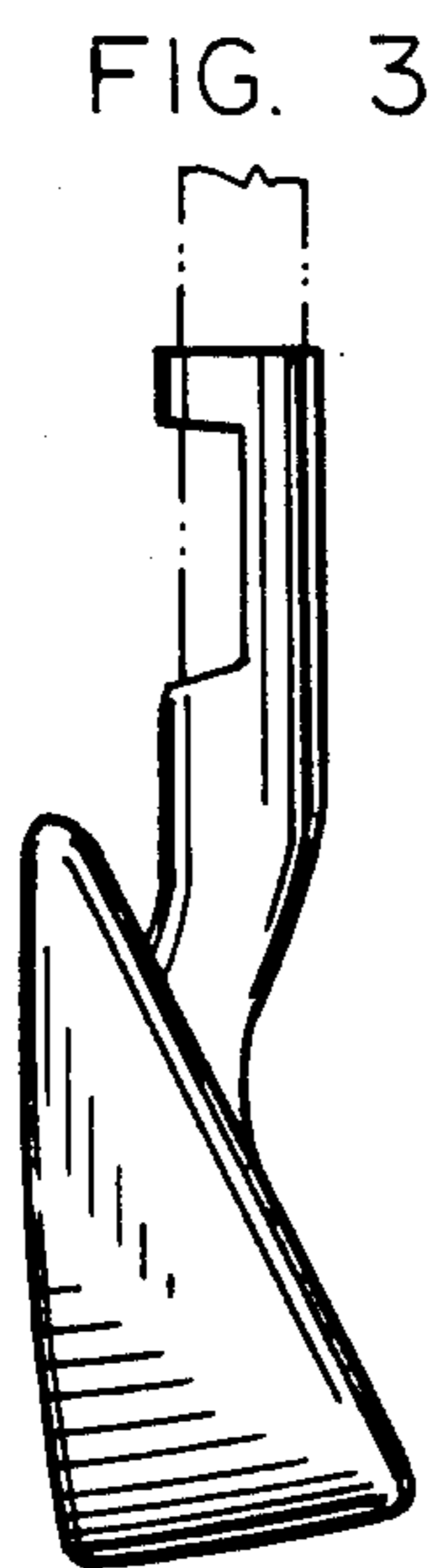

FIG. 3

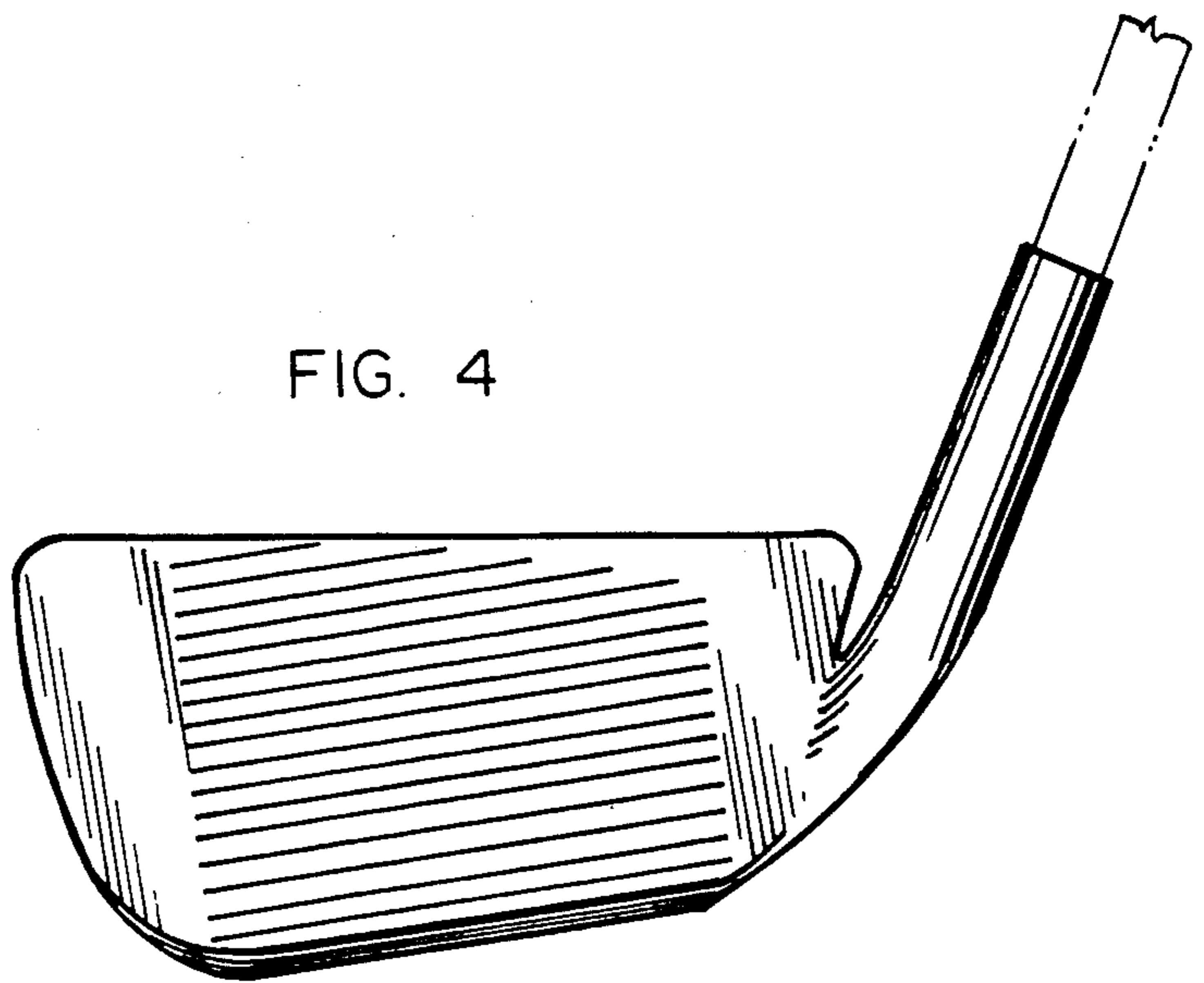

FIG. 4

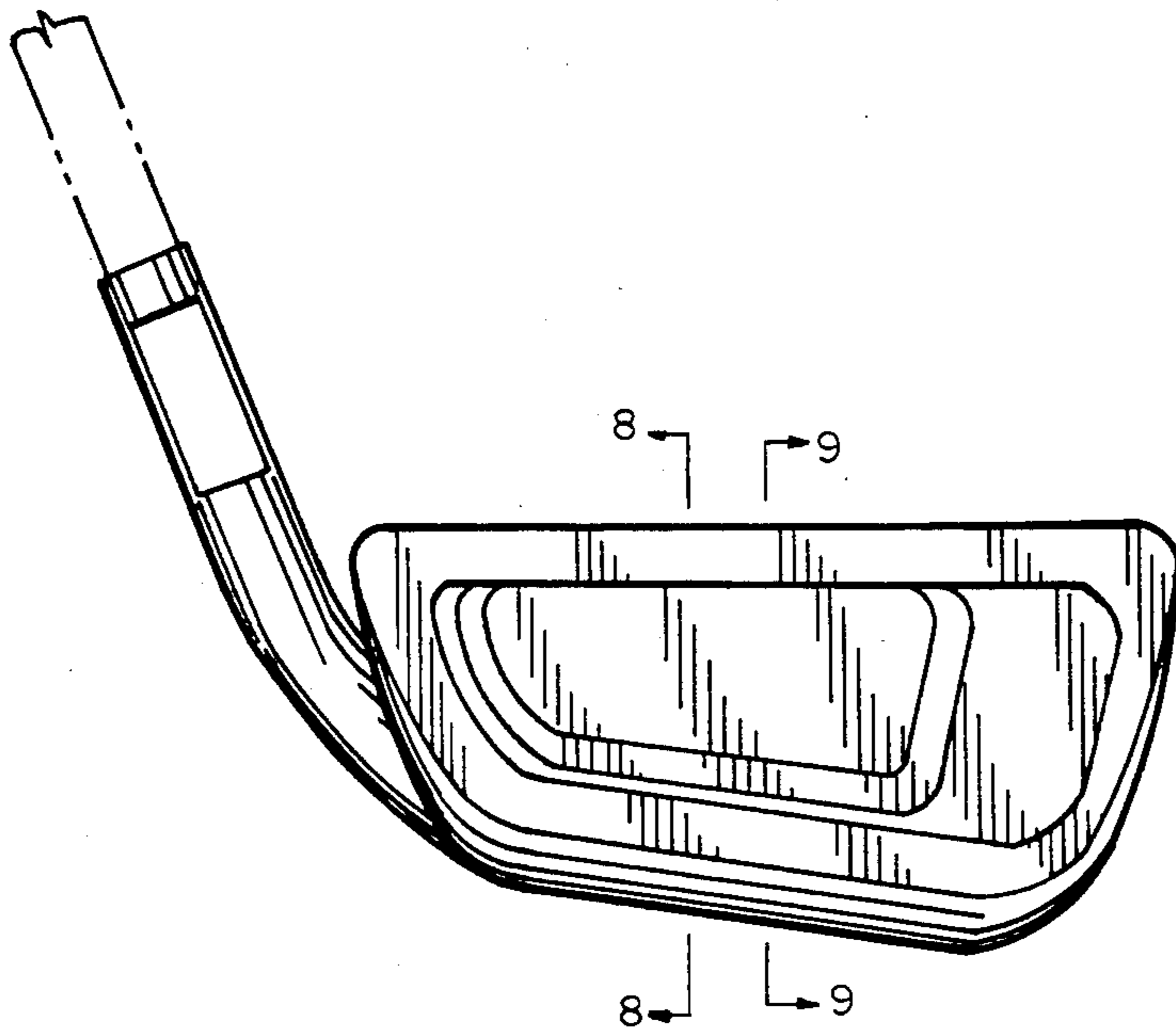

FIG. 5

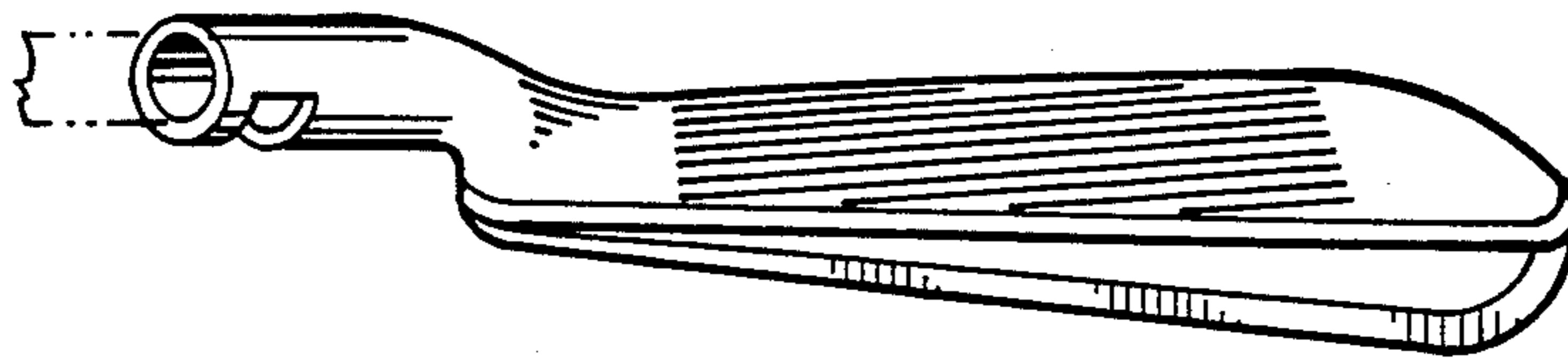

FIG. 6

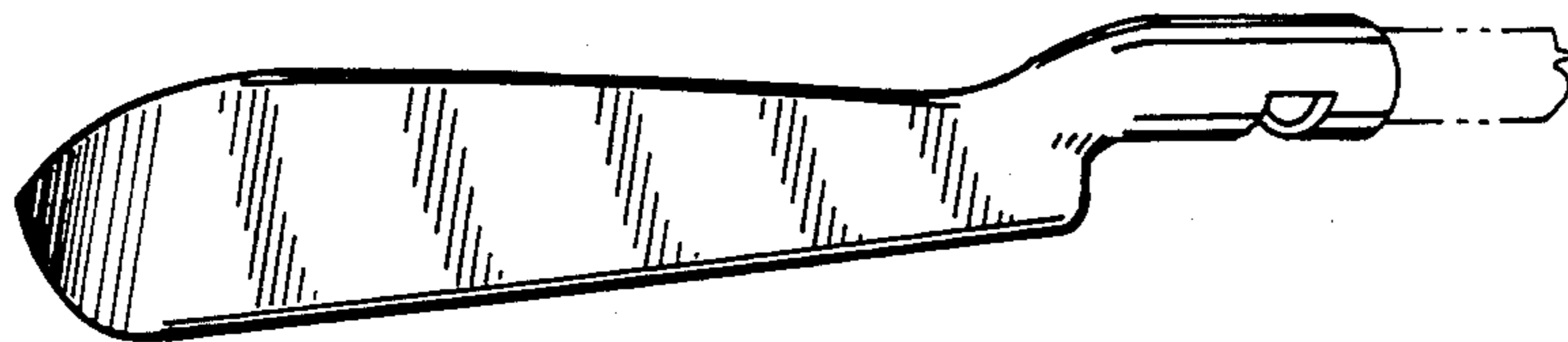

FIG. 7

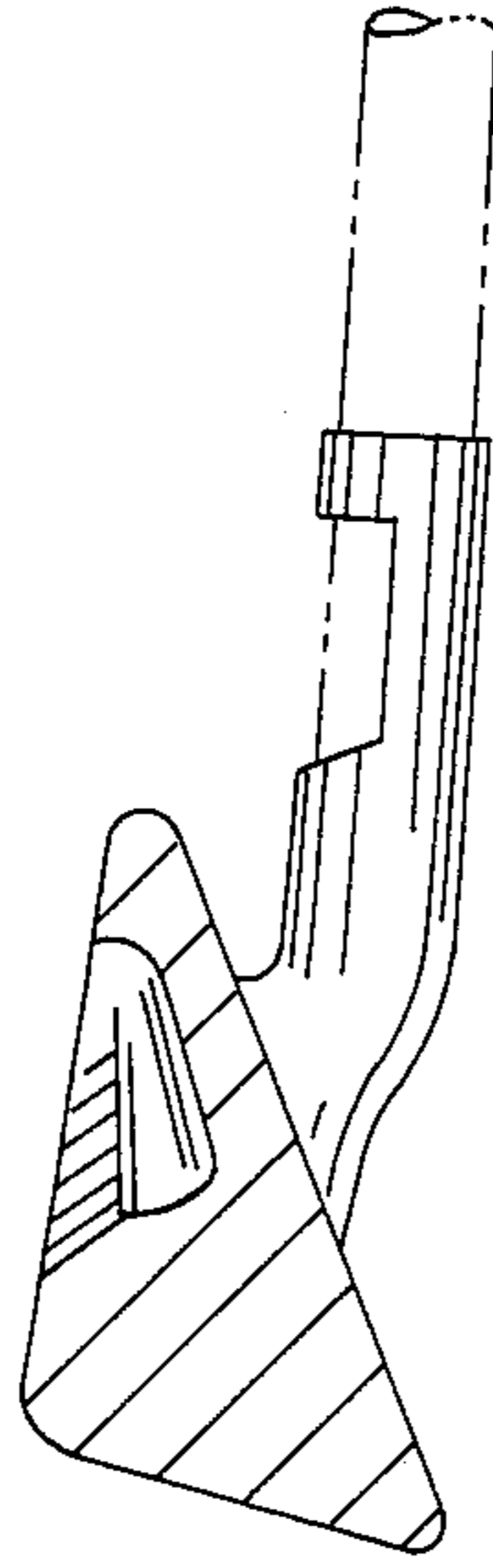

FIG. 8

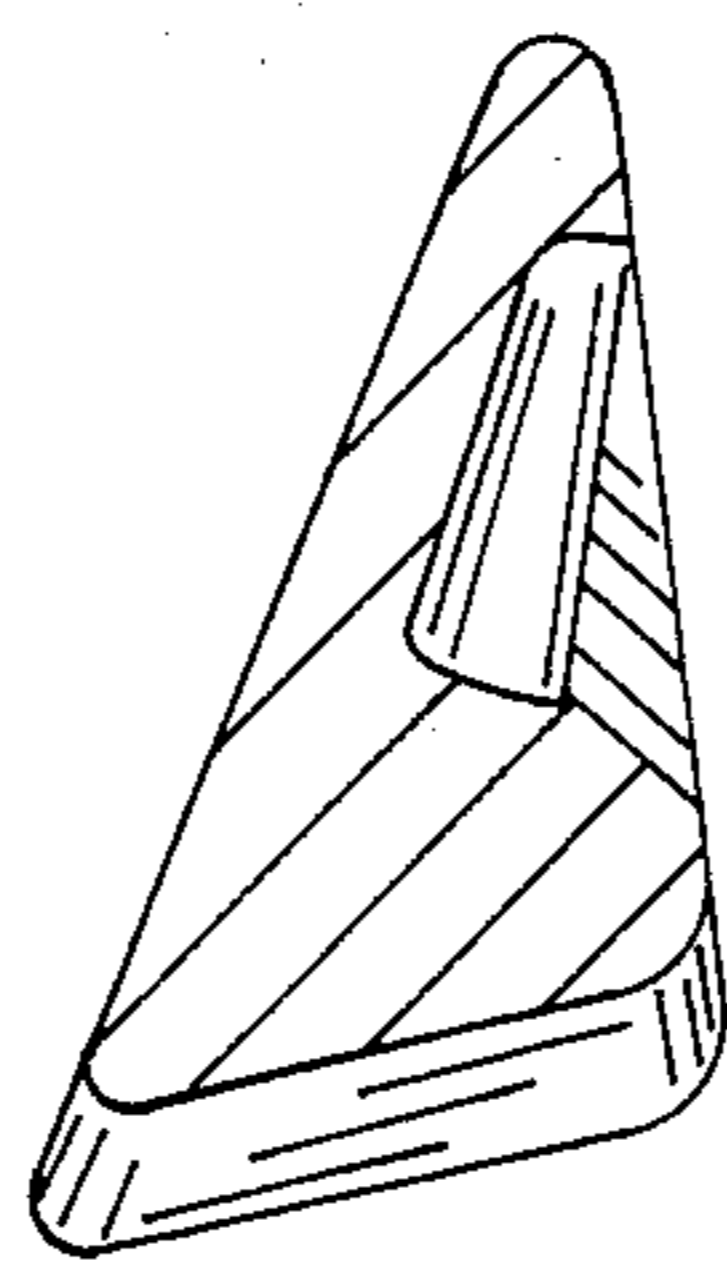

FIG. 9