

[54] CUTTING APPARATUS

[76] Inventor: Ambrose Batiz, 1135 Clark St., Linden, N.J. 07036

[**] Term: 14 Years

[21] Appl. No.: 936,659

[22] Filed: Dec. 1, 1986

[52] U.S. Cl. D7/47

[58] Field of Search D7/47; 83/856, 858; 30/121.5

[56] References Cited

U.S. PATENT DOCUMENTS

D. 264,542 5/1982 Doyel D7/47 X

OTHER PUBLICATIONS

Hong Kong Household, 12/84, p. 56, Grater, bottom of page.

Primary Examiner—Bernard Ansher
Assistant Examiner—Terry Pfeffer
Attorney, Agent, or Firm—George A. Bode

[57] CLAIM

The ornamental design for a cutting apparatus, as shown and described.

DESCRIPTION

FIG. 1 is a perspective view of a cutting apparatus showing my new design;
FIG. 2 is a front elevational view thereof;
FIG. 3 is a rear elevational view thereof;
FIG. 4 is a top plan view thereof;
FIG. 5 is a bottom plan view thereof; and
FIG. 6 is a right side elevational view thereof, the opposite side being a mirror image.

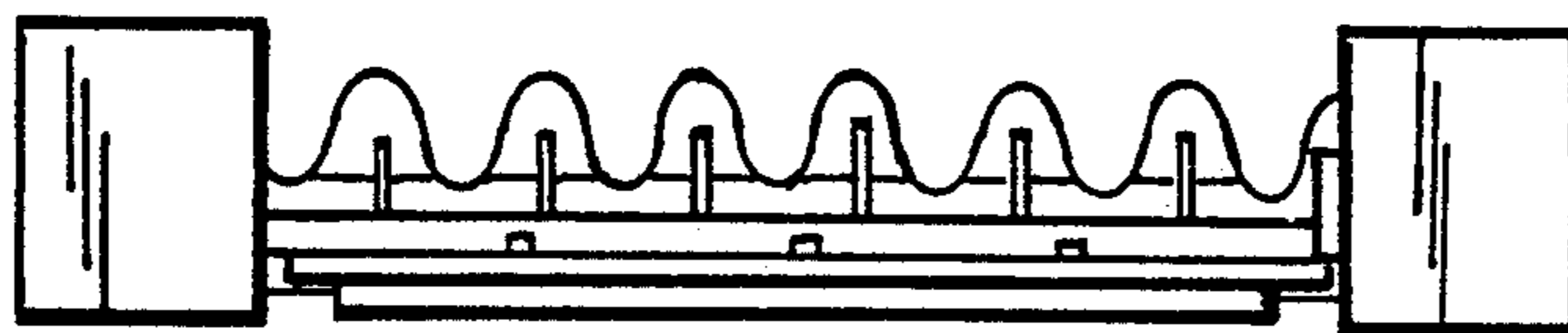
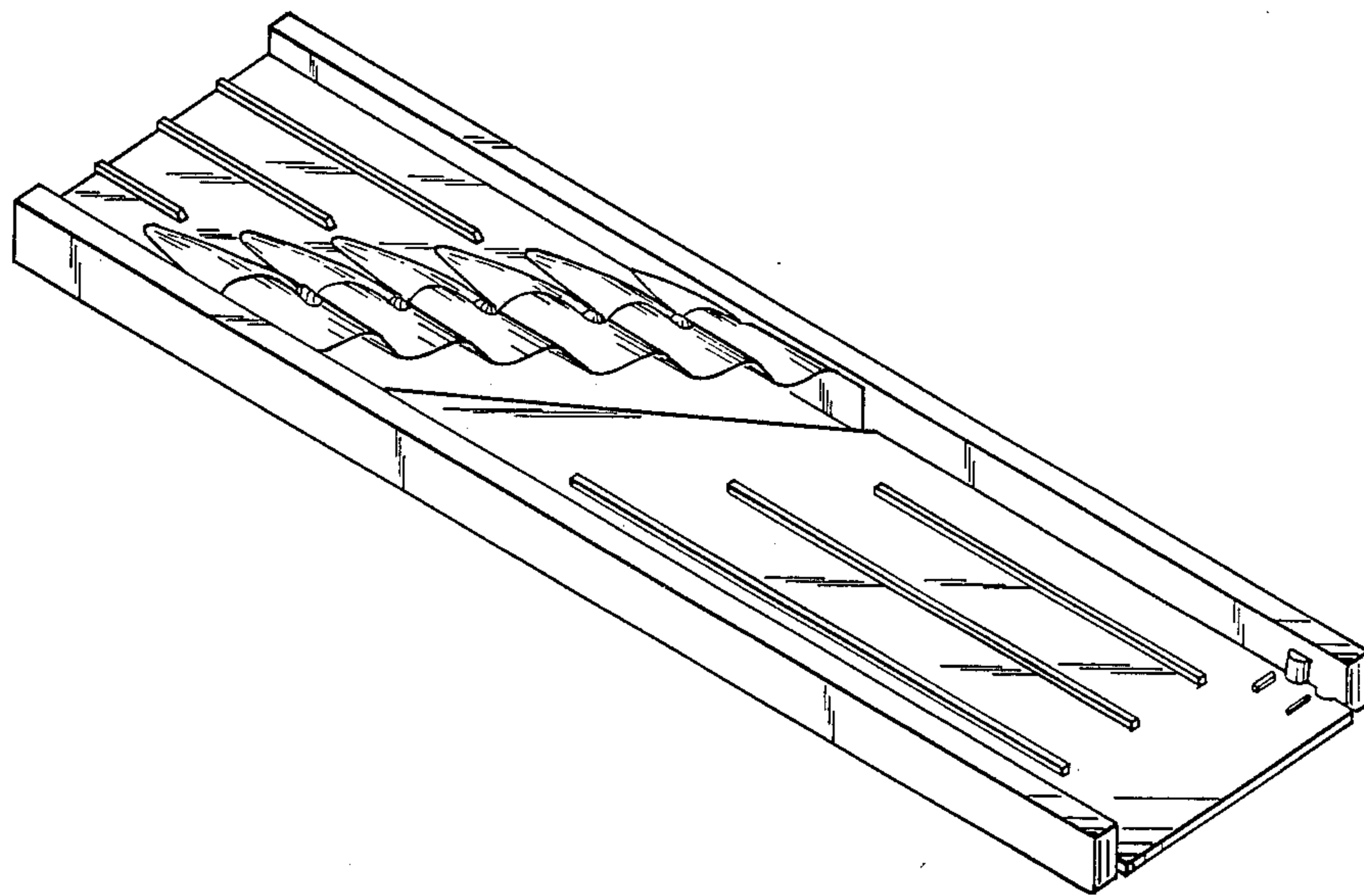

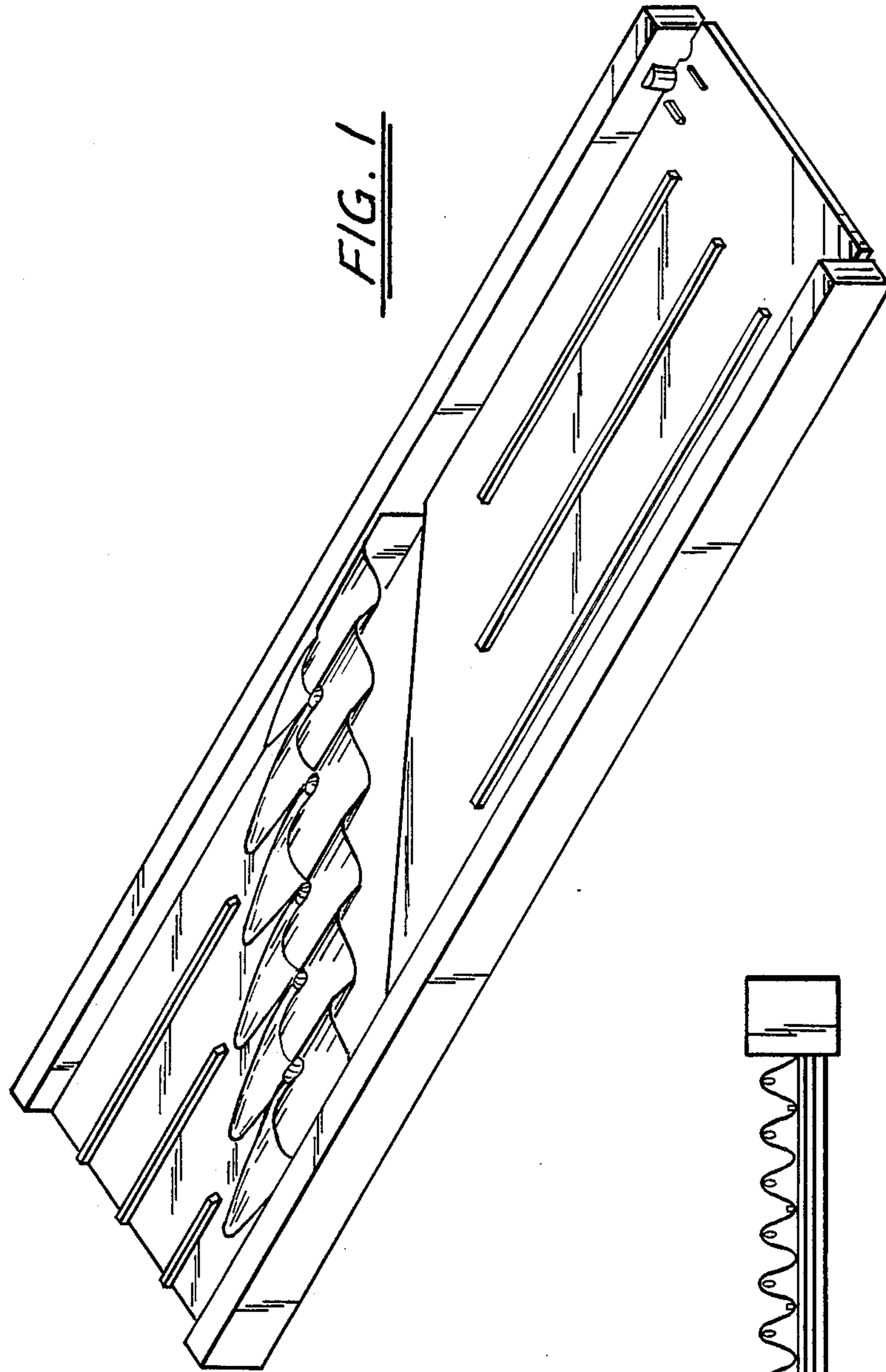

FIG. 1

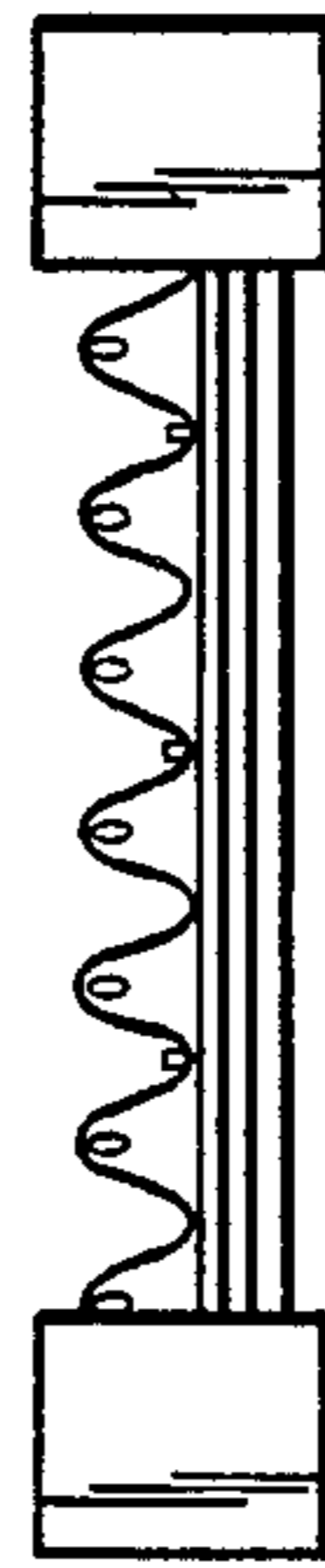

FIG. 3

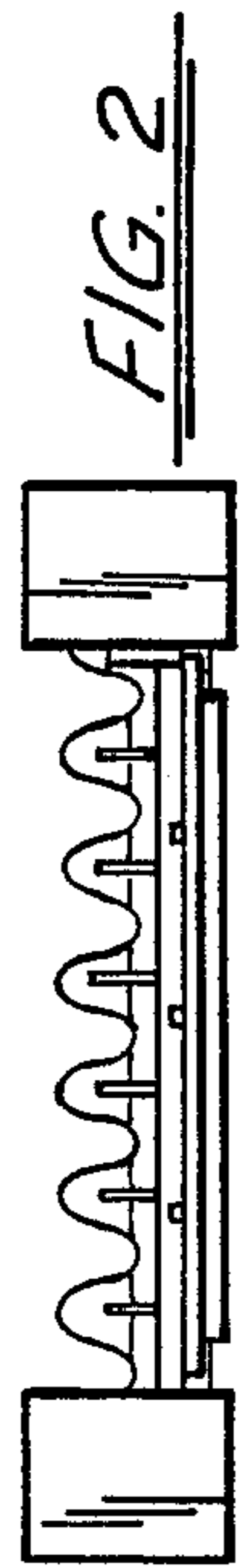

FIG. 2

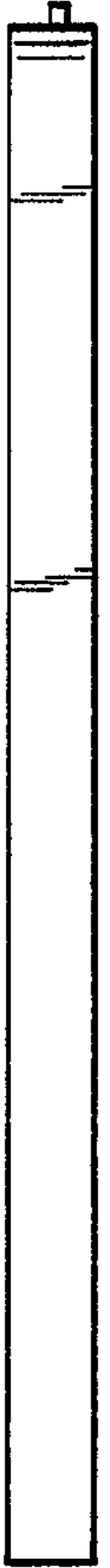

FIG. 6

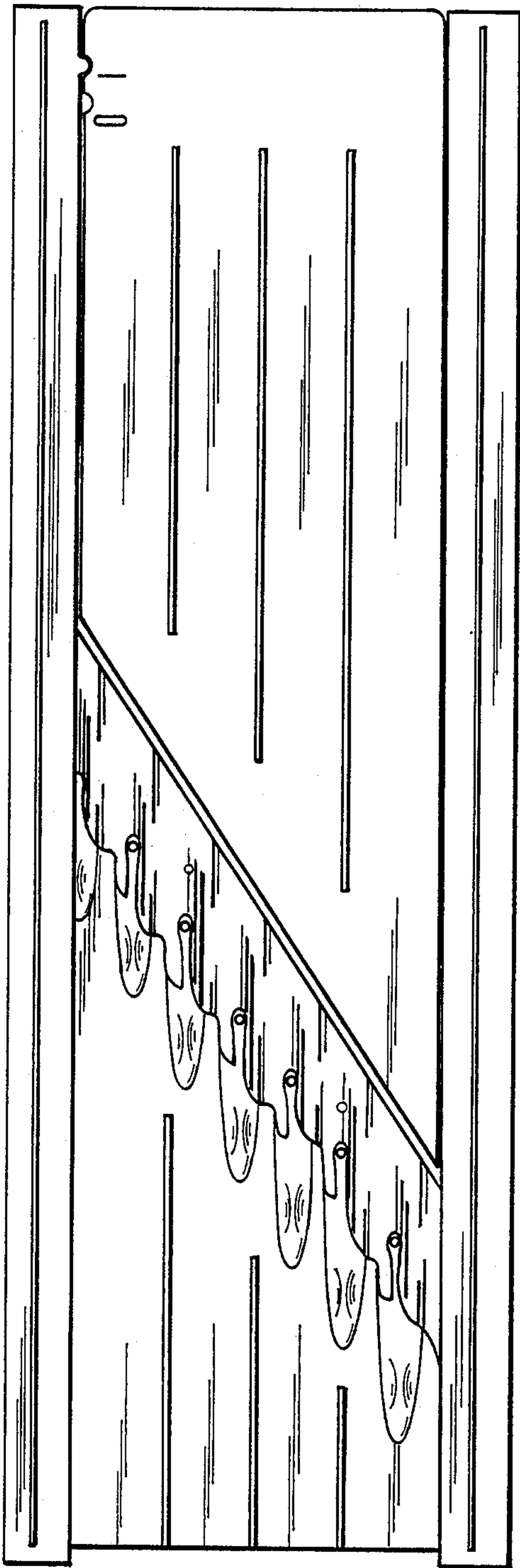

FIG. 4

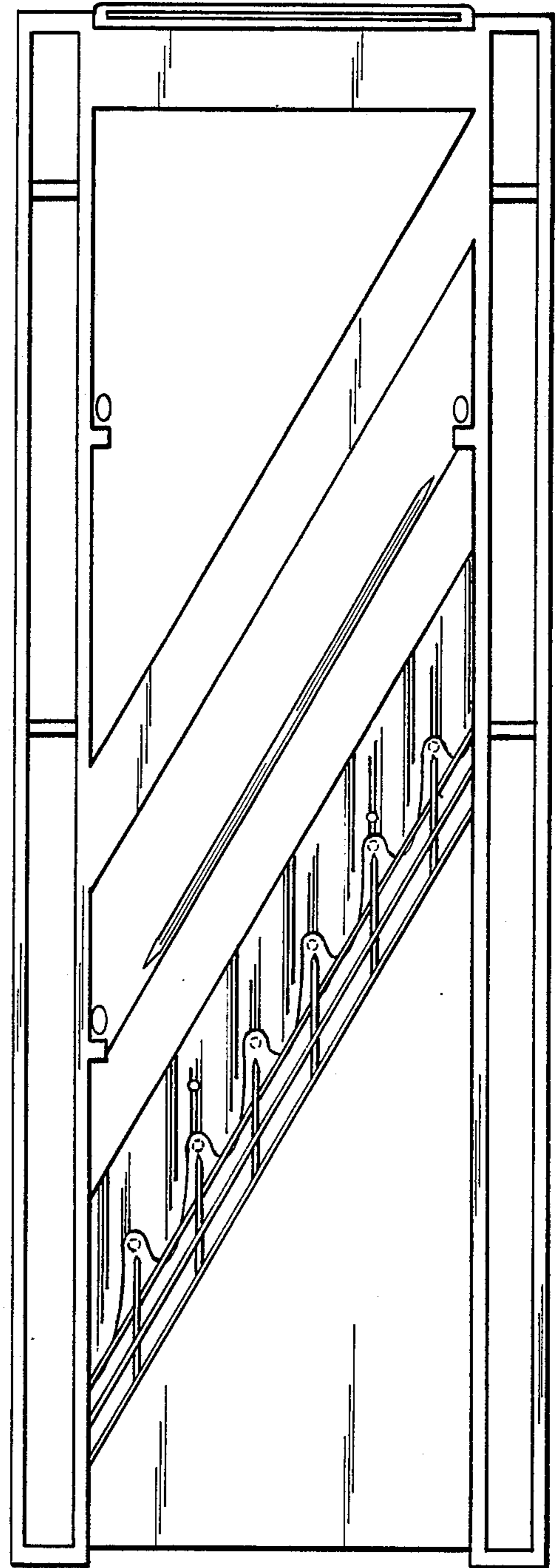

FIG. 5